

**KWC DVS**

Professional

# Washroom Solutions

Specification Edition 2

## LOOKOUT FOR INFORM ENABLED



INFORM offers unparalleled control, monitoring, and verification across the product range. This includes integrated taps and spouts suitable for all sectors. With INFORM, you can:

- Programme and control solenoid valves remotely.
  - View live and historical data on temperature and solenoid valve usage.
  - Access an easy-to-use, fully configurable platform with a range of programmable events.
- All of this helps you ensure a safe and compliant water system.

**LOOKOUT FOR OUR INFORM ENABLED PRODUCTS THROUGHOUT THE BROCHURE**

# Contents

## Table of contents

KWC DVS INTRODUCTION	1 - 9
OUR MATERIAL RANGE	10 - 17
PROJECT REFERENCES	18 - 23
TAPS AND SPOUTS	24 - 43
WASHBASINS & WASHTROUGHES	44 - 61
GLACIER ALL IN ONE MIRROR SYSTEM	62 - 67
CLINICAL OUTLETS	68- 71
INFORM OUTLET TAPS	72 - 77
SURGEON SCRUB TROUGHES	78 - 81
MEDICAL & UTILITY SINKS	82 - 93
URINALS	94 - 103
WCS	102 - 115
SHOWERS	116 - 129
ACCESSIBLE WASHROOMS	130 - 149
NURSERY WASHROOMS	150 - 155
BABY CHANGE	156 - 159
ACCESSORIES	160 - 185
LIGATURE RESISTANT & HIGH SECURITY	186 - 225
CATERING	226 - 243
DRINKING FOUNTAINS	244 - 249

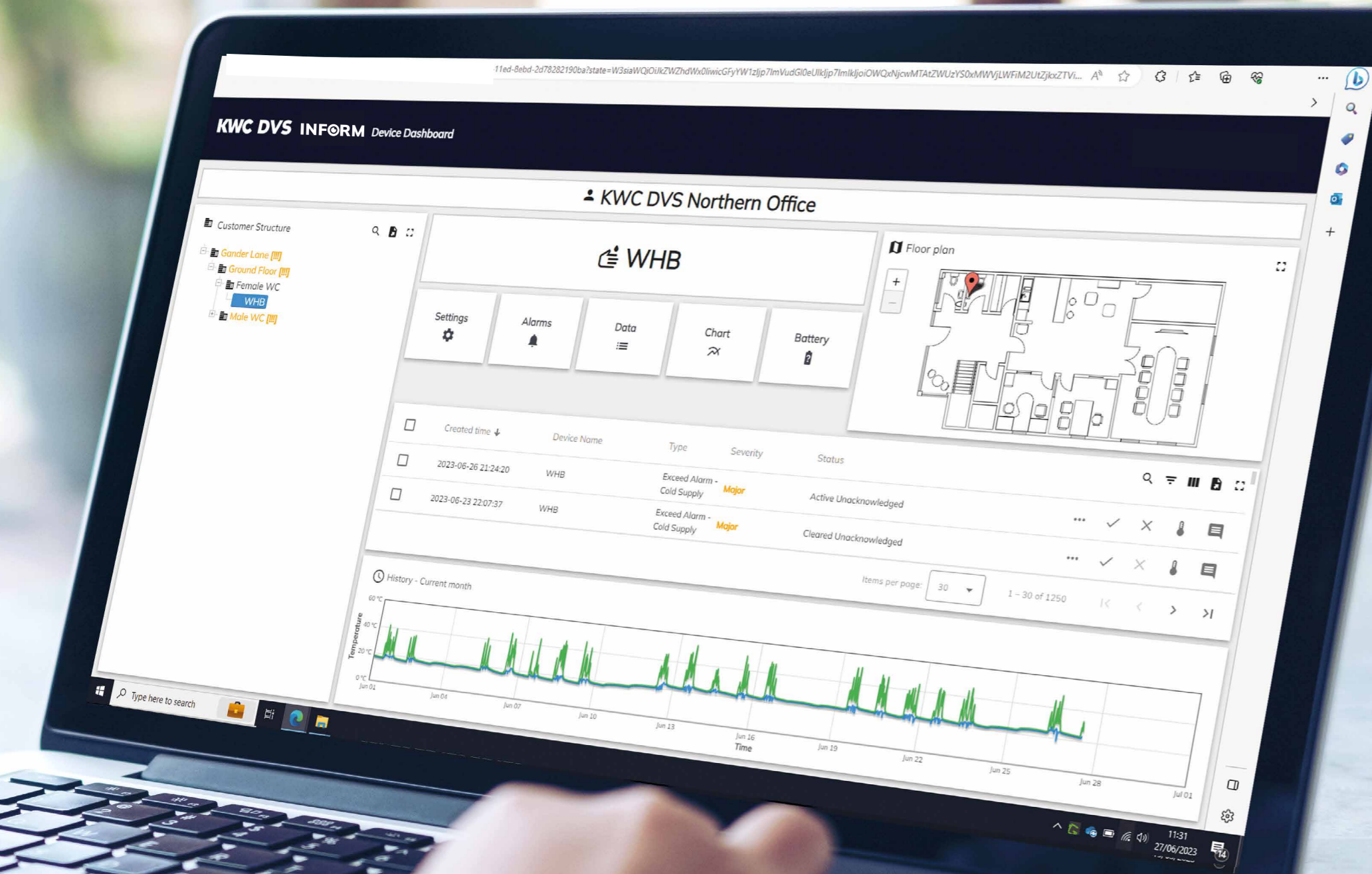



KWC ME LLC, Ras Al Khaimah, United Arab Emirates

## KWC DVS

# Over 235 years of washroom expertise and knowledge

Specialising in water saving technology for commercial washrooms, KWC DVS Ltd. has been producing leading automatic washroom technology for over 35 years. KWC DVS is a market leader in the field of water-saving products along with automatic washroom products for specialist applications, including healthcare, mental healthcare, custodial and the public sector.



KWC Aquarotter GmbH, Ludwigsfelde, Germany



KWC DVS Northern Office, Chesterfield, UK



KWC DVS Southern Office, Devon, UK

Alongside our extensive product portfolio, an expert team of engineers are on hand to support installations, whilst our technical sales teams give tailored project support and specification advice.

The KWC Group combines the benefits of reduced water consumption with a focus on hygienic design. KWC DVS are proud to be part of a global Group that produces products which have been used in both domestic and commercial environments for many years.

The KWC brand brings together a collection of international expertise which forms KWC Group. We unite our global washroom divisions under the new KWC brand.

Together we have been developing and improving our products and expertise for decades, in some cases more than a century. This is what makes us trusted suppliers for major projects across the world.

KWC DVS

# A lifetime of reasons to choose a KWC DVS aftersales package

## Nationwide technical support

Not just another manufacturer, KWC DVS have a fully trained and approved service and installation team servicing the needs of the UK nationwide. All KWC DVS engineers are City & Guilds certified, washroom product experts and undergo extensive Health and Safety training. At our Paignton Head Office, we also have an industry leading after-sales team on hand to make things that little bit easier.

## Commissioning – 5 Year on-site warranty upgrade

Want to install it yourself but make sure everything is as it should be? Our commissioning package is an affordable way to make sure the installation is compliant, efficient and all products have the correct settings to meet the demands of your new washroom.

Products commissioned by us benefit from an enhanced warranty, upgrading the standard 5 year warranty to an onsite warranty for additional peace of mind.

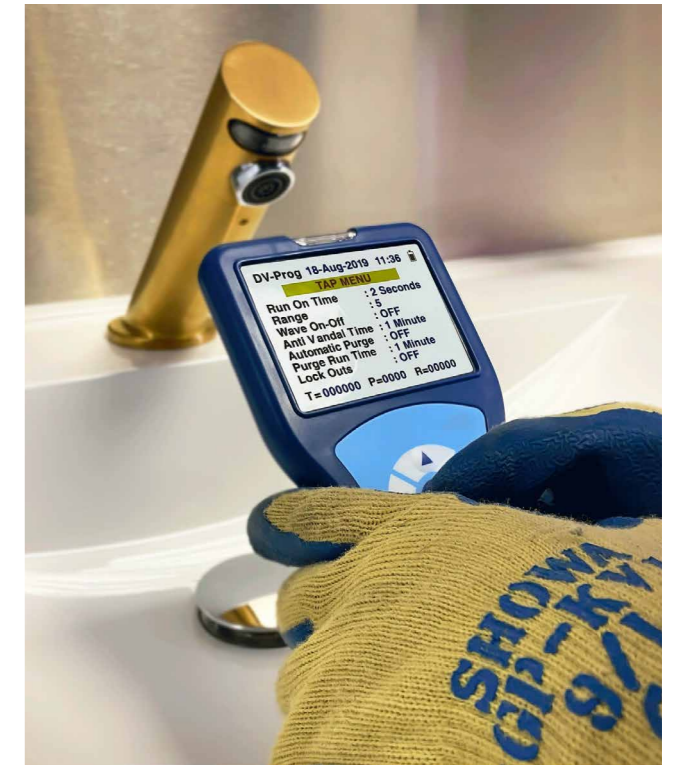

## Sign up to a service plan and protect your products with an industry leading lifetime warranty

### Installation – 5 Year on-site warranty upgrade

Guarantee it's done right and choose installation by our installation experts. With the added peace of mind we'll provide an on-site warranty for 5 years for any parts we have installed or commissioned.

Our installation team operate nationwide and have extensive experience across a number of sectors including transport, healthcare, mental healthcare, custodial and retail.

### Servicing – Lifetime warranty upgrade

Investing in our annual service package is the best way to protect the longevity and performance of your washroom water controls. With regular maintenance and parts replacement, we ensure that your controls are operating with optimum water efficiency, minimising waste and maximising performance. By maintaining a live service package, you can enjoy the peace of mind that comes with a lifetime warranty for all eligible products. Trust us to keep your washroom water controls in top condition for years to come.

Contact our Aftersales team now to discuss your package options

Email: [kwcdvstechsupport@kwc.com](mailto:kwcdvstechsupport@kwc.com)

Tel: +44 (0) 1803 529021

# Welcome to the world of INFORM

## Not just another monitoring system

The INFORM system has been designed to allow you to take complete control of your water system. INFORM's 4 key functions include water temperature monitoring (INFORM Monitor) wireless control of solenoid valves (INFORM Control) outlets that can monitor temperature (INFORM Outlet) and a service portal (INFORM Service). When installed correctly and used in conjunction with one another, you can ensure water safety for all your buildings assets.

The INFORM system is available via a user friendly web based platform that can be accessed 24/7 on phones, tablets or PCs. The dashboard allows for fully configurable alarms, audit trails and exportable reports which give you the management information you need to ensure you have a safe water system and aid compliance. If you would like to discuss a free trial please contact us.

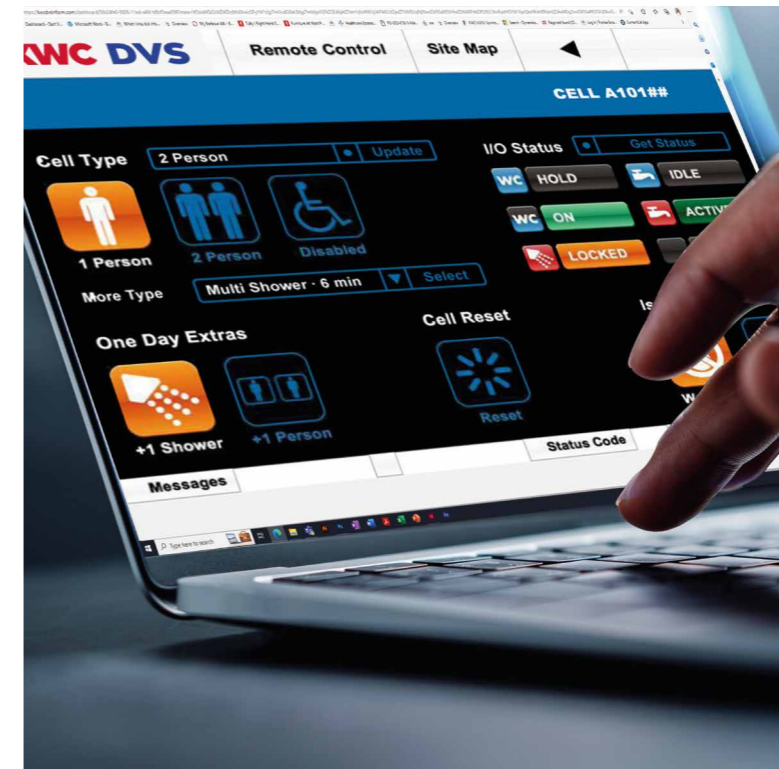

### INFORM Control

A range of products that provide unrivalled remote control of power sockets, lighting and water in individual or multiple rooms. Options include the ability to effortlessly oversee individual rooms or exercise centralised control over an entire section, all with just a few clicks. Inform Control products can remotely control, monitor, disinfect and verify multiple events including: remote wireless control of valves, remote or on-site programming, quantifying valve operations, timed & dynamic hygiene purges, identify infrequently used outlets, monitor temperatures, thermal disinfections & cold water isolation checks on TMVs etc. With a selection of user friendly, configurable alarms which can be set to alert when required temperature or usage profiles are not met, thereby aiding compliance

### INFORM Outlet

Outlet has been developed to help to accurately measure the water temperature as close as possible to the point of discharge. Inform Outlets all feature an in-built anti-microbial outlet and thermistors which connect directly to the Inform platform. The range includes taps, spouts, shower towers, vanity units, basins etc



### INFORM Monitor

This smart digital solution provides detailed, exportable data for current and historical periods. You can understand how your water system temperatures perform, to see trends and the impact of operational changes or remedial works. Identifying high-performing areas can allow replication and improvement across your water system. Inform Monitor data empowers confident decisions with clear evidence, replacing guesswork and assumptions. Prioritise areas of greatest need and maximize efficiency.



## Quality materials

# Miranit® and GRP - Robust solid surface materials for all environments

## Miranit composite

Miranit® is made of shatter-proof, resin-bonded mineral granite, providing a modern and aesthetically pleasing design in public and semi-public environments. Cast in a single mould without adhesive seams or joints, Miranit® products feature the following important characteristics: high stability, elegant appearance and high durability due to the smooth, pore-free, hygienic and easy-to-maintain gelcoat surface.

Miranit® is a stable compound consisting of approximately 80% natural minerals such as marble, sandstone and quartz sand and about 20% high-quality unsaturated polyester resin. The final product is highly stable in combination with the unsaturated polyester resin, it also has excellent forming characteristics to facilitate easy production into cast moulds. This makes it possible to create products of almost any shape.

Miranit has many advantages compared to traditional ceramic sanitaryware. Sanitary products manufactured under the brand name Miranit® can be classed under the generic term 'cast mineral products'. Compared to other cast products, such as ceramic sanitaryware, Miranit® products have the following advantages:

- Hygienic surface finish
- Resistant to temperatures up to 80°C
- Smooth, pore-free and high-gloss gelcoat surface
- Cast in a single mould without any seams or joints
- Impact resistance and shatter-proof
- A fracture-resistant compound made of natural minerals
- The small radii of surface edges provide a modern design
- Integrated accessories add a unified feel
- Customisable and bespoke options available
- A max. length of 3.6m for bespoke washbasins
- Bespoke washbasins can be cut to length on-site
- Choice of colours and integrated accessories
- Choice of finishes - high-gloss or solid matt



Miranit contains 80% natural minerals such as marble, sandstone and quartz sand and approximately 20% high-quality unsaturated polyester resin.



## Glass Reinforced Polyester - MOJ approved for the most demanding of environments

Our Glass reinforced polyester (GRP) is a high impact and corrosion-resistant composite material. Our expertise of working with GRP in both the Mental Health and Custodial sectors span many decades. Our expert UK based team are able to produce safe, ligature resistant products that best meet the needs of the client and associated regulatory bodies in these fields. Tried and tested by the NHS, MOJ and MOD in the toughest of environments.

Although lightweight and easy to mount on existing structures, GRP is also extremely robust. The production technique to manufacture GRP is similar to that used to produce ballistic armour. It is finished with a thick white gel coat, which makes it highly durable and provides a modern finish. GRP is also fire retardant, making it ideal for high security or correctional facilities.

GRP is well suited when designing load-bearing products such as sanitaryware because its high-strength properties can fulfil the requirements for this application. GRP also allows for less material to be used than other structural materials. These properties make GRP the ideal product for high-security environments, ensuring ligature resistance and long-lasting product life.

Our GRP products have been meticulously crafted for the most stringent high-security environments. Designed with unwavering focus on safety, these products stand as a testament to our commitment to providing safety within mental health and high-security environments.

Quality materials

# Stainless steel - a hygienic, durable and low maintenance solution

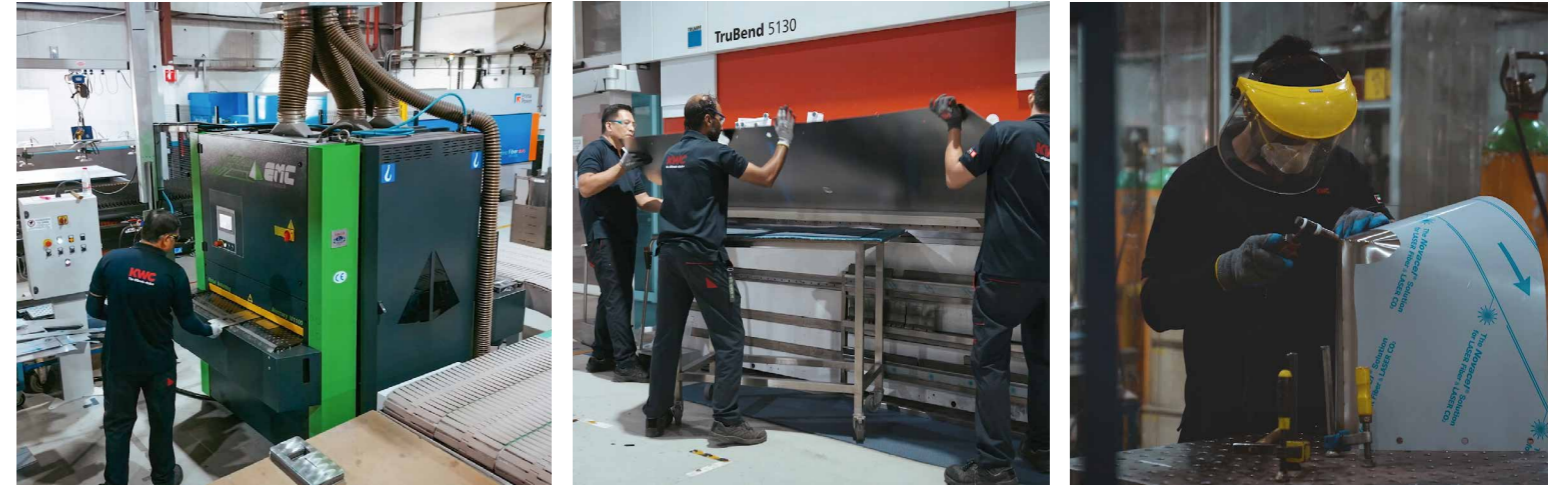

## Stainless steel

Washroom products manufactured from stainless steel inhibit vandalism and are easy to clean, helping building operators keep service and maintenance costs to a minimum.

Stainless steel is not only resistant to moisture and most acids, it also stands out due to its strength, hygienic characteristics and high tolerance to hot and cold temperatures, making it an ideal choice for hospitals and food processing plants. Dirt and oil can easily be washed from the smooth, pore-free surface without harsh cleaning products.

Stainless steel is a low-carbon steel that contains at least 10.5% chromium (Cr) and no more than 1.2% carbon (C).

They form a self-regenerating surface layer that gives the material resistance to corrosion and improves performance compared to unalloyed steels.

Chromium is the key ingredient which makes it stainless and rust-resistant. Therefore, it ages gracefully. KWC uses steels with a higher chromium content and nickel alloy for its sanitary products, increasing its resistance to corrosion..

### Surfaces overview

Material number 1.4301 (AISI 304) is used in accordance with DIN EN 10088. 304 stainless steel is manufactured with 18% chromium and 10% nickel, giving the material its particular characteristics. Stainless steel is 100% recyclable.



## Washroom sanitaryware

# Ceramics - the SanCeram collection

Looking for the perfect ceramic sanitaryware to complement your KWC DVS automatic washroom products? Look no further than the SanCeram collection, which includes WC pans, urinals, and basins. Made from high-quality vitreous china that meets BS 3402 standards, these ceramics feature an integral glaze that resists water absorption, burning, stains, scratching, and even acid or alkali attacks. By pairing SanCeram ceramics with KWC DVS products, you can enjoy a complete washroom solution that's both easy and professional.

### The SanCeram Promise

#### Quality Guarantee

We promise to bring our customers the very best products in the market place. That's why we are confident to offer a 25 year warranty on all our ceramics.

#### Extensive Product Range

Our breadth of range is extraordinary. Whatever the project, whatever the space, we have a product that fits, perfectly. Surprisingly Affordable

We don't believe in nasty surprises. With SanCeram you have our word that quality and style won't cost you a fortune.

#### Unrivalled Support

Our team of experts are on hand to help you every step of the way. From choosing the right product, through to technical and installation queries, we are only a call or email away.

#### Environmentally Friendly

We are dedicated to preserving our planet. The SanCeram range is manufactured using eco-friendly methods and our water saving products will help toward earning BREEAM credits.

## Why choose us?



#### Cost Effective

Savings of up to 40%



#### 25 Year Warranty

Our ceramics come with a 25 year warranty



#### Approved & Certified

SanCeram contains HBN, DDA, WRAS approved and LABC certified products



#### Contemporary Styling

Inspired, modern designs without compromising on quality



#### Specification Support

We are on hand to offer support through our free NBS writing service



#### Technical Support

Dedicated technical team to offer support and advice throughout the project



#### Speedy Delivery

Fast and efficient delivery, stocked items delivered within 48 hours







**BioMaster pioneered the use of anti-microbial additives and remains the recognised leader and most trusted supplier of anti-microbial technology for polymers textiles, paints and coatings.**



We have a range of products manufactured using BioMaster such as Multi-Spouts, anti-microbial valves, station kits and more, providing ultimate hygiene in public or semi-public environments. Our **NEW INFORM Outlet** water temperature monitoring tap features an anti-microbial outlet made with BioMaster and can be operated using our BioMaster anti-microbial valves.

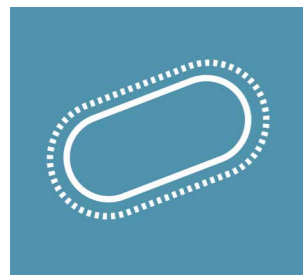

BioMaster binds to the cell wall disrupting growth.

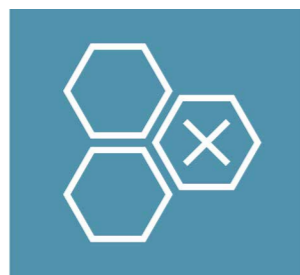

The silver ions stop the cell from producing energy



...and interrupt the cells DNA, preventing replication

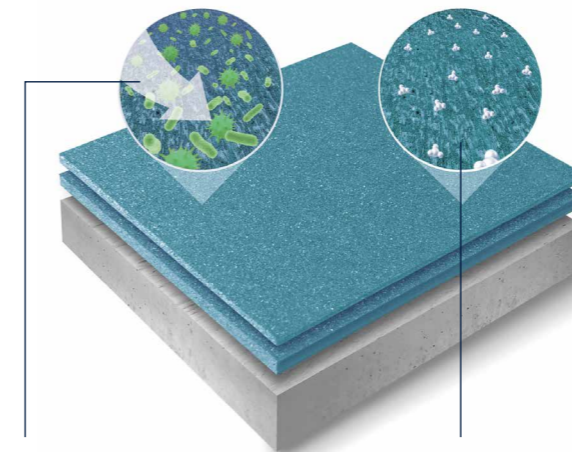

WITHOUT BIOMASTER™

Microbes settle and multiply on surfaces, causing degradation.

WITH BIOMASTER™

Silver ions actively inhibit all microbes and protects the surface.

### BIOMASTER REDUCTION TIMES\*

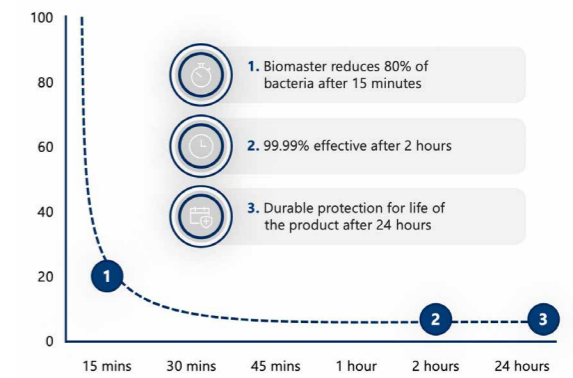

\*For illustrative purposes only, actual reduction rate varies depending on material and addition rate

### How effective is BioMaster?

Very. Polygiene BioMaster™ is proven to inhibit the growth of microbes by up to 99.99%.

### Is BioMaster safe?

Yes. It is based on silver ion technology, recognised for centuries with no harmful effects. Polygiene is used in medical, food and water applications.

### What's the difference between antimicrobial and antibacterial?

An antimicrobial inhibits the growth of, or destroys harmful microorganisms such as bacteria, fungi and moulds. An antibacterial specifically prevents the growth of bacteria.

### Has BioMaster been tested?

Yes, repeatedly. BioMaster is tested to ISO standards. We also undertake on-going quality control tests and environmental trials.

### How long is BioMaster effective for?

BioMaster is effective for the intended lifetime of the product it's added to. It is built-in and doesn't wear off or leach out.

### Does BioMaster affect a product in any way?

No. You can't see, smell or even taste BioMaster.

### Can a BioMaster-treated polymer be recycled?

Yes. It can be recycled effectively without any complications

## Project references



### Revolutionising Water Management at Great Ormond Street Hospital

The world's leading children's hospital, Great Ormond Street, has undertaken a monumental transformation, and at the heart of this redevelopment stood the need for an advanced water management solution. KWC DVS were on hand to provide support for this flagship project. Our intelligent water management system is helping significantly improve both hygiene and water efficiency through convenient central monitoring and control.

### Water saving solutions for Europe's busiest airport - Heathrow

Selected as the preferred partner for washrooms throughout Britain's largest airport including the most recently built Terminal 2, "The Queen's Terminal". This remarkable partnership showcases our cutting-edge solutions in flush valves, urinal controls, automatic taps and accessories. Heathrow Airport has successfully acquired products that align with their water conservation needs, catering to the anticipated 60 million passengers annually. The robustness and resilience of KWC DVS products are primed to withstand the rigorous demands of high footfall, promising substantial operational savings alongside unparalleled performance.



### Premier water controls for Premier League football - The Tottenham Hotspur stadium

KWC DVS were selected to provide upgraded washroom systems for the prestigious Tottenham Hotspur Stadium in North London. This internationally renowned, multi-purpose arena with a capacity of 62,850 hosts a diverse range of events, from football matches to concerts, NFL games and Rugby Union tournaments. Our collaboration with this iconic venue exemplifies our commitment to elevating washroom experiences while championing water conservation. The primary goal of the project was to create hygienic and inviting washrooms whilst ensuring responsible water usage.

Given the substantial foot traffic expected in a stadium of this magnitude, our tailored solution seamlessly integrated both objectives. DVS put forward customised programmable sensors for WCs, urinals and showers alongside WC flush valves. These products can be fully optimised and programmed on-site using the handheld programmer, allowing different settings to be applied to products to best suit the stadium's needs. For example, all urinals now have the shortest possible walk away time, providing a full flush as often as possible to keep the bowls clean whilst saving water. Our contribution to the Tottenham Hotspur Stadium project showcases KWC DVS's dedication to technical excellence, innovation, and sustainability. As we move forward, we continue to be the preferred partner for those seeking first-class solutions that seamlessly blend quality, cutting-edge technology, and environmental responsibility.



# Project references

## HMP Durham, washrooms solutions for the most demanding environments

HM Prison Durham, a Category B men's prison built in 1819, embarked on a house block renovation project. A key aspect was ensuring the new washrooms were not only secure and resistant to impact, ligature, and vandalism, but also provided a safe and hygienic environment for both inmates and staff.

KWC DVS were selected as the preferred supplier and provided a comprehensive washroom solution that addressed all project requirements, including MOJ-Approved Combination Units and Intelligent Washroom Controls. The results of this partnership were enhanced water safety, reduced vandalism, and improved efficiency. The project demonstrates the effectiveness of KWC DVS' solutions in high-security environments.



## P22 Project – St Anns Mental Health Unit, London

St. Anns, London, new mental health inpatient building Blossom Court underwent its second phase and specified KWC DVS GRP and stainless-steel products for the project. The plans for the redevelopment of St Ann's Hospital were developed with patients, staff and local stakeholders and involved a series of improvements. Following completion of the new inpatient unit in summer 2020, Phase 2 includes the refurbishment of other buildings, a new restaurant for visitors and staff and improvements to the site power and water supplies, roadways, car parking and landscaping.

Designing sanitaryware for mental health and high-security environments can be a challenge; however, the KWC DVS branded safe ensuite range is manufactured using advanced technologies provides the perfect solution. These high-security and ligature resistant products are virtually unbreakable and create a safe solution within all mental health facilities.



## Ferndene Hospital, Northumberland

Ferndene, based in Prudhoe, Northumberland, is a custom-built inpatient Centre that specializes in treatment for young people with various health, behavioural and emotional requirements. The Centre opened its doors in Autumn 2011 and has four different units that cater to inpatients' specific needs. The units provide educational and social facilities with modern amenities to create supportive and therapeutic environments. For their latest refurbishment the Centre specified KWC DVS products. Our safe en-suite range is intended for the toughest of environments and manufactured using advanced technologies. Robust, vandal resistant and avoiding ligature points where possible, the range is highly resistant to recurrent stresses and high impact. Designed with a high-grade polyester gel coat surface, the design is aesthetically pleasing and can be used in conjunction with our latest range of floor and wall mounted WC pans. With a rear concealed outlet that can be removed if required, the customer is guaranteed a product that is both secure and easy to maintain.



# International project references

## Belfast City Hospital, Northern Ireland

The Belfast City Hospital located in Northern Ireland, is a 900-bed modern University Teaching Hospital providing local acute services and key regional specialities. Designed to the highest building and infection control standards. Medi-10 Autoclavable spouts have been installed to provide the ability to carry out and monitor hygiene purges.

The autoclavable design of the Medi-10 spout provides the on-site team with the ability to easily disinfect the outlets, away from the ward whilst minimising downtime. The Medi-10 range also includes the functionality to attach point of use filters as required. Coupled with our intelligent water management system, the Trust can control valves, monitor temperatures, see valve counts, set timed hygiene purges and identify infrequently used outlets etc. All events are monitored, verified and form part of the extensive range of management information available.



## The Louvre Abu Dhabi, UAE

The £1 Billion Art Museum houses 26 individual galleries and is exhibiting pieces from many famous artists including Van Gogh and Picasso. To compliment this luxurious building, premium and hygienic hand washing facilities in the washrooms were key. KWC DVS No-touch taps were chosen for the project and hundreds of Aquarius outlets were installed throughout the site. The Aquarius range provided the perfect match for coping with high traffic, in addition to meeting the aesthetic requirements of such a prestigious building.

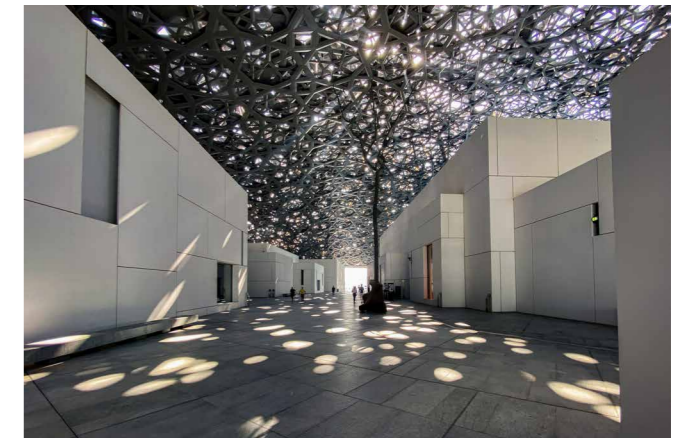

## Queen Alia International Airport, Jordan

Jordan has one of the lowest levels of water resources availability per capita in the world, which made water saving an important consideration when choosing taps for the ablution room, a place used for ritual cleaning before prayer.

KWC DVS Aquarius taps were therefore an ideal choice not only because the no touch technology is ideal for areas where hygiene is of the highest importance, but also to prevent water wastage for this scarce resource through intelligent shut off. They are also ideal for high traffic washroom areas as demonstrated at comparable sites such as London Heathrow for over two decades.

This was a great project for KWC DVS to be involved with and just one example of many successful projects completed in the Middle East. Queen Alia airport is now capable of handling around 13 million passengers a year which is more than 3 times its previous capacity.

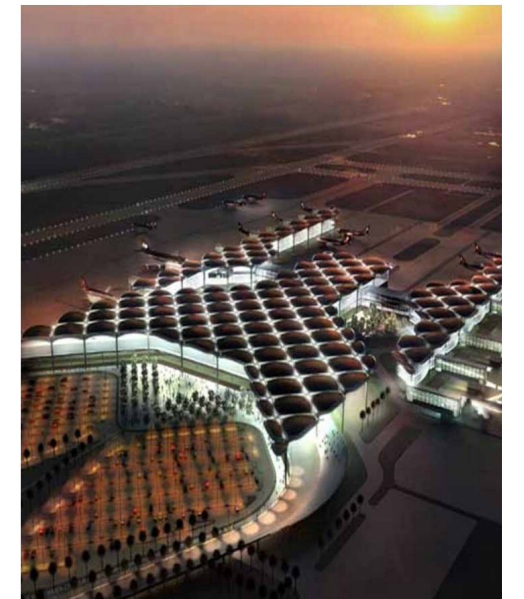



## Taps and spouts

KWC DVS's range of taps and spouts for public and commercial facilities revolutionises the way water is utilised in busy restrooms. By combining user convenience with optimal hygiene, these taps contribute to water conservation efforts while maintaining high standards of cleanliness. This makes them an excellent choice for any location with a constant influx of users, promoting sustainability and ensuring a pleasant restroom experience for all.

# 316 Stainless steel taps built to last

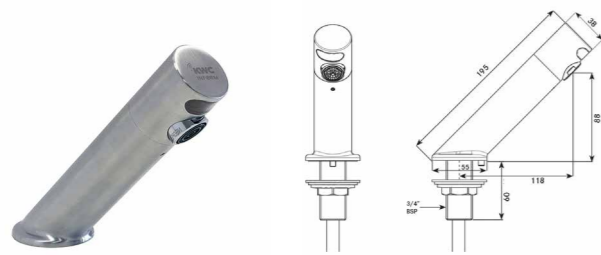

## AQUARIUS A45 TAP SPOUT - BRUSHED

Aquarius deck mounted A45 tap manufactured in 316 stainless steel with a brushed finish. Sensor operated for maximum hygiene and efficiency. 5 litres per minute integrated flow control. (other flow rates available). Designed with automatic purge function, sensor range adjustment, wave on/wave off function, anti vandal and lock out functions and a chlorination function.

Spout projection: 118mm

AT03-011 With PEX hose (15mm)

AT03-012 With copper tails (10mm)

### Mandatory Accessories;

AT00-221 Single station antimicrobial mains kit

AC17-047 TMV3

### Complimentary Accessories;

SD01-012 A45 soap dispenser



## AQUARIUS A45 DOC M TAP SPOUT - BRUSHED

Aquarius deck mounted A45 Doc M tap manufactured in 316 stainless steel with a brushed finish. Sensor operated for maximum hygiene and efficiency. 5 litres per minute integrated flow control. (other flow rates available). Designed with automatic purge function, sensor range adjustment, wave on/wave off function, anti vandal and lock out functions and a chlorination function.

Spout projection: 97mm

AT03-021 With PEX hose (15mm)

AT03-022 With copper tails (10mm)

### Mandatory Accessories;

AT00-221 Single station antimicrobial mains kit

AC17-047 TMV3

### Complimentary Accessories;

SD01-012 A45 soap dispenser



## AQUARIUS A32 TAP SPOUT - BRUSHED

Aquarius deck mounted A32 tap manufactured in 316 stainless steel with a brushed finish. Sensor operated for maximum hygiene and efficiency. 5 litres per minute integrated flow control. (other flow rates available). Designed with automatic purge function, sensor range adjustment, wave on/wave off function, anti vandal and lock out functions and a chlorination function.

Spout projection: 140mm

AT03-001 With PEX hose (15mm)

AT03-002 With copper tails (10mm)

### Mandatory Accessories;

AT00-221 Single station antimicrobial mains kit

AC17-047 TMV3

### Complimentary Accessories;

SD01-012 A45 soap dispenser



## AQUARIUS TAP 150MM - BRUSHED

Aquarius 150mm wall mounted tap manufactured in 316 stainless steel with a brushed finish. Sensor operated for maximum hygiene and efficiency. 5 litres per minute integrated flow control. (other flow rates available). Designed with automatic purge function, sensor range adjustment, wave on/wave off function, anti vandal and lock out functions and a chlorination function.

Spout projection: 120mm

AT02-001 With PEX hose (15mm)

AT02-002 With copper tails (10mm)

AT02-003 Stainless tail (10mm)

### Mandatory Accessories;

AT00-221 Single station antimicrobial mains kit

AC17-047 TMV3

### Complimentary Accessories;

SD01-005 Wall mounted soap dispenser



## AQUARIUS TAP 200MM - BRUSHED

Aquarius 200mm wall mounted tap manufactured in 316 stainless steel with a brushed finish. Sensor operated for maximum hygiene and efficiency. 5 litres per minute integrated flow control. (other flow rates available). Designed with automatic purge function, sensor range adjustment, wave on/wave off function, anti vandal and lock out functions and a chlorination function.

Spout projection: 170mm

AT02-011 With PEX hose (15mm)

AT02-012 With copper tails (10mm)

AT02-013 Stainless tail (10mm)

### Mandatory Accessories;

AT00-221 Single station antimicrobial mains kit

AC17-047 TMV3

### Complimentary Accessories;

SD01-005 Wall mounted soap dispenser



## AQUARIUS TAP 250MM - BRUSHED

Aquarius 250mm wall mounted tap manufactured in 316 stainless steel with a brushed finish. Sensor operated for maximum hygiene and efficiency. 5 litres per minute integrated flow control. (other flow rates available). Designed with automatic purge function, sensor range adjustment, wave on/wave off function, anti vandal and lock out functions and a chlorination function.

Spout projection: 220mm

AT02-021 With PEX hose (15mm)

AT02-023 With copper tails (10mm)

AT02-024 Stainless tail (10mm)

### Mandatory Accessories;

AT00-221 Single station antimicrobial mains kit

AC17-047 TMV3

### Complimentary Accessories;

SD01-005 Wall mounted soap dispenser

# Polished 316 Stainless steel taps

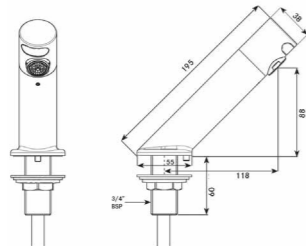

### AQUARIUS A45 TAP SPOUT - POLISHED

Aquarius deck mounted A45 tap manufactured in 316 stainless steel with a polished finish. Sensor operated for maximum hygiene and efficiency. 5 litres per minute integrated flow control. (other flow rates available). Designed with automatic purge function, sensor range adjustment, wave on/wave off function, anti vandal and lock out functions and a chlorination function.  
Spout projection: 118mm

- AT03-013 With PEX hose (15mm)
- AT03-014 With copper tails (10mm)
- Mandatory Accessories;**
- AT00-221 Single station antimicrobial mains kit
- AC17-047 TMV3
- Complimentary Accessories;**
- SD01-013 A45 soap dispenser

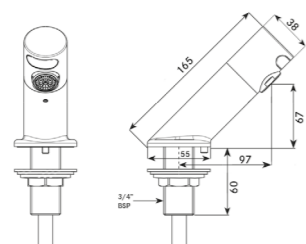

### AQUARIUS A45 DOC M TAP SPOUT - POLISHED

Aquarius deck mounted A45 Doc M tap manufactured in 316 stainless steel with a polished finish. Sensor operated for maximum hygiene and efficiency. 5 litres per minute integrated flow control. (other flow rates available). Designed with automatic purge function, sensor range adjustment, wave on/wave off function, anti vandal and lock out functions and a chlorination function.  
Spout projection: 97mm

- AT03-023 With PEX hose (15mm)
- AT03-024 With copper tails (10mm)
- Mandatory Accessories;**
- AT00-221 Single station antimicrobial mains kit
- AC17-047 TMV3
- Complimentary Accessories;**
- SD01-013 A45 soap dispenser

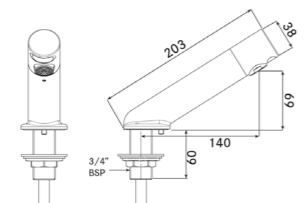

### AQUARIUS A32 TAP SPOUT - POLISHED

Aquarius deck mounted A32 tap manufactured in 316 stainless steel with a polished finish. Sensor operated for maximum hygiene and efficiency. 5 litres per minute integrated flow control. (other flow rates available). Designed with automatic purge function, sensor range adjustment, wave on/wave off function, anti vandal and lock out functions and a chlorination function.  
Spout projection: 140mm

- AT03-003 With PEX hose (15mm)
- AT03-004 With copper tails (10mm)
- Mandatory Accessories;**
- AT00-221 Single station antimicrobial mains kit
- AC17-047 TMV3
- Complimentary Accessories;**
- SD01-013 A45 soap dispenser

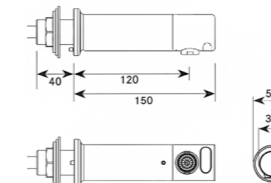

### AQUARIUS TAP 150MM - POLISHED

Aquarius 150mm wall mounted tap manufactured in 316 stainless steel with a polished finish. Sensor operated for maximum hygiene and efficiency. 5 litres per minute integrated flow control. (other flow rates available). Designed with automatic purge function, sensor range adjustment, wave on/wave off function, anti vandal and lock out functions and a chlorination function.  
Spout projection: 120mm

- AT02-005 With PEX hose (15mm)
- AT02-006 With copper tails (10mm)
- Mandatory Accessories;**
- AT00-221 Single station antimicrobial mains kit
- AC17-047 TMV3
- Complimentary Accessories;**
- SD01-001 Wall mounted soap dispenser

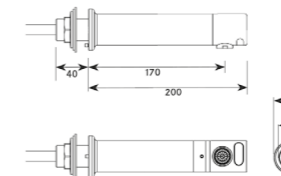

### AQUARIUS TAP 200MM - POLISHED

Aquarius 200mm wall mounted tap manufactured in 316 stainless steel with a polished finish. Sensor operated for maximum hygiene and efficiency. 5 litres per minute integrated flow control. (other flow rates available). Designed with automatic purge function, sensor range adjustment, wave on/wave off function, anti vandal and lock out functions and a chlorination function.  
Spout projection: 170mm

- AT02-015 With PEX hose (15mm)
- AT02-016 With copper tails (10mm)
- Mandatory Accessories;**
- AT00-221 Single station antimicrobial mains kit
- AC17-047 TMV3
- Complimentary Accessories;**
- SD01-001 Wall mounted soap dispenser

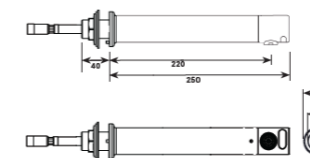

### AQUARIUS TAP 250MM - POLISHED

Aquarius 250mm wall mounted tap manufactured in 316 stainless steel with a polished finish. Sensor operated for maximum hygiene and efficiency. 5 litres per minute integrated flow control. (other flow rates available). Designed with automatic purge function, sensor range adjustment, wave on/wave off function, anti vandal and lock out functions and a chlorination function.  
Spout projection: 220mm

- AT02-025 With PEX hose (15mm)
- AT02-026 With copper tails (10mm)
- Mandatory Accessories;**
- AT00-221 Single station antimicrobial mains kit
- AC17-047 TMV3
- Complimentary Accessories;**
- SD01-001 Wall mounted soap dispenser

# Taps and spouts

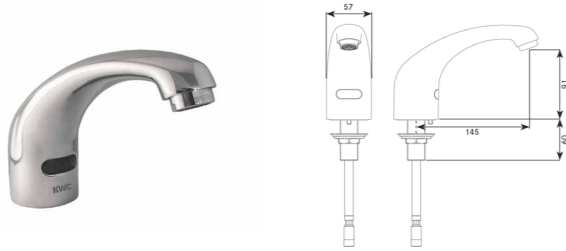

## CLASSIC TOUCH-FREE TAP

Classic touch-free tap manufactured in brass with a chromed finish. Sensor operated for maximum hygiene and efficiency. 5 litres per minute integrated flow control (other flow rates available). Designed with automatic purge function, sensor range adjustment, wave on/wave off function, anti vandal and lock out functions and a chlorination function.

Spout projection: 145mm

**AT01-001** With PEX hose (15mm)

**AT01-002** With copper tails (10mm)

**AT01-003** With stainless tails (10mm)

### Mandatory Accessories;

**AT00-221** Single station antimicrobial mains kit

**AC17-047** TMV3

### Complimentary Accessories;

**SD01-002** Swan neck soap dispenser



## CLASSIC SWAN TOUCH-FREE TAP

Classic Swan touch-free tap manufactured in brass with a chromed finish. Sensor operated for maximum hygiene and efficiency. 5 litres per minute integrated flow control (other flow rates available). Designed with automatic purge function, sensor range adjustment, wave on/wave off function, anti vandal and lock out functions and a chlorination function.

Spout projection: 145mm

**AT01-011** With PEX hose (15mm)

**AT01-012** With copper tails (10mm)

**AT01-013** With stainless tails (10mm)

### Mandatory Accessories;

**AT00-221** Single station antimicrobial mains kit

**AC17-047** TMV3

### Complimentary Accessories;

**SD01-002** Swan neck soap dispenser



## AQUARIUS HIGH NECK TAP

Aquarius high neck tap manufactured from 316 stainless steel with a brushed or polished finish. Sensor operated for maximum hygiene and efficiency. 5 litres per minute integrated flow control (other flow rates available). Designed with automatic purge function, sensor range adjustment, wave on/wave off function, anti vandal and lock out functions and a chlorination function.

Spout projection: 130mm

**AT03-041** Brushed with PEX hose (15mm)

**AT03-043** Polished with PEX hose (15mm)

### Mandatory Accessories;

**AT00-221** Single station antimicrobial mains kit

**AC17-047** TMV3

### Complimentary Accessories;

**SD01-008** Pillar soap dispenser (Nickel brushed)

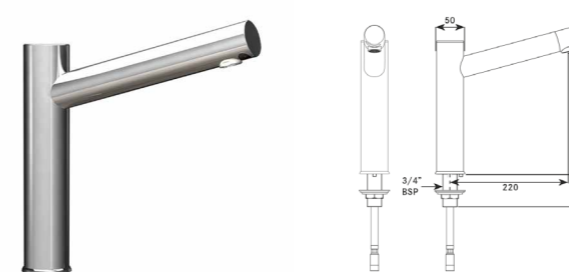

## AQUARIUS TALL PILLAR TAP

Aquarius tall pillar tap manufactured in brass with a chromed finish. Sensor operated for maximum hygiene and efficiency. 5 litres per minute integrated flow control (other flow rates available). Designed with automatic purge function, sensor range adjustment, wave on/wave off function, anti vandal and lock out functions and a chlorination function. Single mixed feed connection by With PEX lined hose (15mm connection).

Spout projection: 220mm

**AT03-061** Tall pillar tap

### Mandatory Accessories;

**AT00-221** Single station antimicrobial mains kit

**AC17-047** TMV3

### Complimentary Accessories;

**SD01-003** Pillar soap dispenser (chrome)

**SW00-066** Rectangular Langley countertop basin

**SW00-067** Circular Langley countertop basin

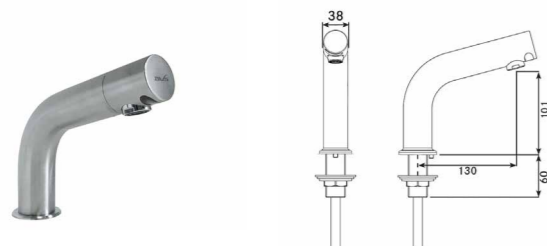

## AQUARIUS SHORT NECK TAP

Aquarius short neck tap manufactured from 316 stainless steel with a brushed finish. Sensor operated for maximum hygiene and efficiency. 5 litres per minute integrated flow control (other flow rates available). Designed with automatic purge function, sensor range adjustment, wave on/wave off function, anti vandal and lock out functions and a chlorination function.

Spout projection: 130mm

**AT03-031** Brushed with PEX hose (15mm)

**AT03-032** Brushed with copper tails (10mm)

**AT03-034** Polished with PEX hose (15mm)

### Mandatory Accessories;

**AT00-221** Single station antimicrobial mains kit

**AC17-047** TMV3

### Complimentary Accessories;

**SD01-008** Pillar soap dispenser (Nickel brushed)

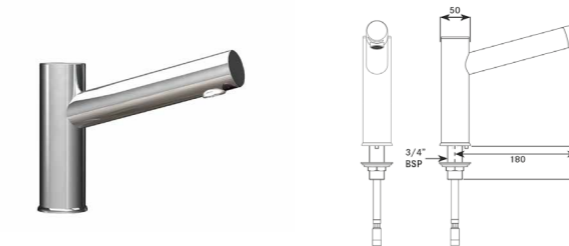

## AQUARIUS SHORT PILLAR TAP

Aquarius short pillar tap manufactured in brass with a chromed finish. Sensor operated for maximum hygiene and efficiency. 5 litres per minute integrated flow control (other flow rates available). Designed with automatic purge function, sensor range adjustment, wave on/wave off function, anti vandal and lock out functions and a chlorination function. Single mixed feed connection by With PEX lined hose (15mm connection).

Spout projection: 180mm

**AT03-051** Short pillar tap

### Mandatory Accessories;

**AT00-221** Single station antimicrobial mains kit

**AC17-047** TMV3

### Complimentary Accessories;

**SD01-003** Pillar soap dispenser (chrome)

**SW00-066** Rectangular Langley countertop basin

**SW00-067** Circular Langley countertop basin



# F3 & F5 - Functionality meets simplicity and affordability

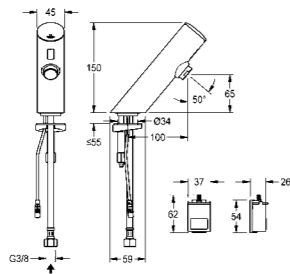

## F3E-MIX ELECTRONIC PRE-MIXED PILLAR TAP - BATTERY

F3E pillar tap DN 15 for sanitary facilities, opto-electronically controlled. For connection to pre-mixed hot or cold water via hose and strainer. Control electronics, solenoid valve cartridge and sensor in all-metal housing, high-polished chromium-plated brass. Activated water hygiene flushing 24 hours after last activation, safety switch-off with continuous reflection and saving of statistical data. If you require additional functionality, such as sensor range adjustment and tap run time, a bi-directional remote is available as an extra.

Supplied with a battery compartment including 6V lithium battery.  
 Supplied with electronics, solenoid valve cartridge and sensor.  
 Flow rate at 3 bar: 6.0 l/min.  
 Dimensions: 45 x 150 x 160mm

**F3EV1001** F3E pillar mixer

**Mandatory Accessories;**

**AC17-047** TMV3

**Complimentary Accessories;**

**SD01-013** A45 soap dispenser (chrome)

**AC01-001** Handheld programmer

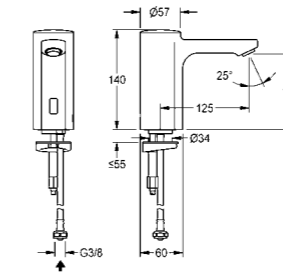

## F5E-MIX ELECTRONIC PRE-MIXED PILLAR TAP - BATTERY

F5E-Mix electronic pre-mixed pillar tap. For connection to pre-mixed hot or cold water via hose and strainer. Control electronics, solenoid valve cartridge, 6 V lithium battery (CR-P2) and sensor in all-metal housing, high-polished chromium-plated brass. Anti-theft aerator, design SLIM, with integrated flow regulator 5.0 l/min. Activated water hygiene flushing 24 hours after last activation, safety switch-off with continuous reflection and saving of statistical data. If you require additional functionality, such as sensor range adjustment and tap run time, a bi-directional remote is available as an extra.

Supplied with 6V lithium battery and sensor  
 Flow rate at 3 bar: 5.0 l/min.  
 Dimensions: 57 X 140mm (W x H)

**F5EV1001** F5E pillar mixer

**Mandatory Accessories;**

**AC17-047** TMV3

**Complimentary Accessories;**

**SD01-003** Pillar soap dispenser (chrome)

**AC01-001** Handheld programmer

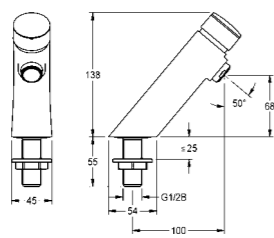

## F3S SELF-CLOSING PRE-MIXED PILLAR TAP

F3S Self-closing pre-mixed pillar tap manufactured from brass with chrome finish. Self-closing cartridge, hydraulically controlled, piston-free design, self-closing, stepless adjustment of flow duration. For connection to pre-mixed hot water or cold water. Casing, high-polished chromium-plated brass.

Flow rate at 3 bar: 3.0 l/min.  
 Dimensions: 45 x 138 x 100mm

**F3SV1101** F3S self-closing pillar tap

**Mandatory Accessories;**

**AC17-047** TMV3

**Complimentary Accessories;**

**SD80** Tabletop soap dispenser

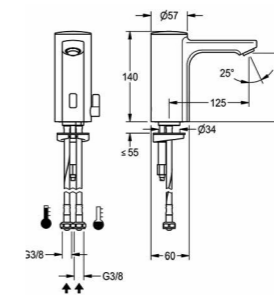

## F5E-MIX ELECTRONIC PILLAR MIXER - BATTERY

F5E-Mix opto-electronically controlled mixer, manufactured from brass with chrome finish. Designed with an adjustable temperature lever with temperature stop. Integrated flush technology which activates 24 hours after the last use. The tap also includes a safety switch-off feature, if you require additional functionality, such as sensor range adjustment and tap run time, a bi-directional remote is available as an extra.

Supplied with control electronics, solenoid valve cartridge  
 Supplied with 6V lithium battery and sensor  
 Flow rate at 3 bar: 0.08l per second  
 Dimensions: 140 x 50 x 163mm

**F5EM1001** F5E pillar mixer

**Complimentary Accessories;**

**SD01-003** Pillar soap dispenser (chrome)

**AC17-047** TMV3

**AC01-001** Handheld programmer

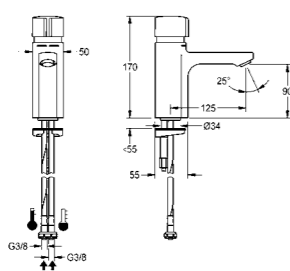

## F5S-MIX SELF-CLOSING PILLAR MIXER TAP

F5S-Mix self-closing pillar mixer manufactured from brass with chrome finish. FRAMIC self-closing mixing cartridge, hydraulically controlled, low-maintenance and stagnation-free, with ceramic disc technology, self-closing, flow pressure-independent due to medium-separated design. Stepless adjustment of flow duration. With adjustable, turn-proof temperature stop. For connection to hot water and cold water via hoses with integrated backflow preventer and strainers. All-metal construction, high-polished chromium-plated brass. Anti-theft aerator, SLIM design.

Flow rate at 3 bar: 5.0 l/min  
 Dimensions: 50 x 170 x 125mm

**F5SM1001** F5S Self-closing pillar mixer

**Complimentary Accessories;**

**SD80** Tabletop soap dispenser

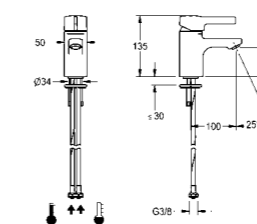

## F5L-MIX PILLAR MIXER - THERMAL PURGE ENABLED

F5L-Mix single-lever mixer as pillar mixer manufactured from brass with chrome finish. Mixing cartridge with ceramic disc technology and thermostatic protection from scalding, permanently set to 41 °C and with safety switch-off in the event of failure of the cold water supply. With a mechanism for an optional hygiene unit for automatic hygiene flushing and program-controlled thermal disinfection. For connection to hot water and cold water via hoses, includes strainers. All-metal construction, high-polished chromium-plated brass. Anti-theft aerator, SLIM design. Spout projection 100mm.

Flow rate at 3 bar: 5.0 l/min.  
 Dimensions: 50 x 135 x 100mm

**F5LT1001** F5L Pillar mixer

**Complimentary Accessories;**

**ACLX1001** Hygiene unit for on-wall installation

**ACLX1005** Hygiene unit for in-wall installation

**SD01-003** Pillar soap dispenser (chrome)

**AC17-047** TMV3

# Taps and spouts

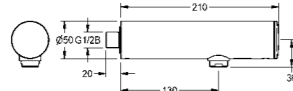

### F3E BIB TAP

F3E bib tap DN 15 wall mounted & sensor operated. For connection to pre-mixed hot or cold water. Control electronics, solenoid valve cartridge, 6 V lithium battery (CR-P2) all housed in the high-polished chromium-plated brass tap body. Hygiene flushing 24 hours after last activation, safety cut-out and saving of statistical data. Flow rate at 3 bar: 6.0 l/min. Dimensions: 50 x 50 x 210mm

**F3EV1004** F3E bib tap

**Mandatory Accessories:**

**AC17-047** TMV3

**Complimentary Accessories:**

**SD01-001** Wall mounted soap dispenser (chrome)

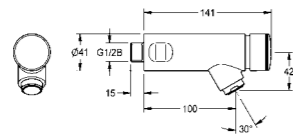

### F3S SELF-CLOSING BIB TAP

F3S self-closing bib tap DN 15 for wall mounting for sanitary facilities. Self-closing cartridge, hydraulically controlled, piston-free design, self-closing, stepless adjustment of flow duration. For connection to pre-mixed hot water or cold water. Casing, high-polished chromium-plated brass.

Flow rate at 3 bar: 3.0 l/min.

Spout projection: 100mm

**F3SV1102** F3S self-closing bib tap

**Mandatory Accessories:**

**AC17-047** TMV3

**Complimentary Accessories:**

**SD110** Wall mounted soap dispenser

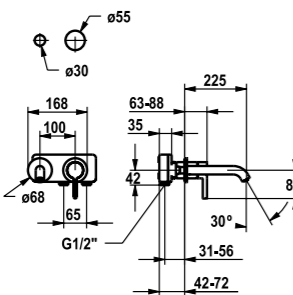

### BEVO LEVER MIXER BASIN TAP

Iconic from every angle. A basin tap manufactured in a brushed steel finish, designed to meet the highest design standards. Timeless elegance in exceptional architecture. Features include:

KWC cartridge M 35 H with ceramic discs

Flow rate 5 l/min (3 bar)

Spout projection: 225mm

**11.422.064.177** Lever mixer brushed finish

**Mandatory Accessories:**

**39.001.401.931** Concealed unit

**Complimentary Accessories:**

**AC00-030** Soap dispenser - stainless steel

**AC17-047** TMV3

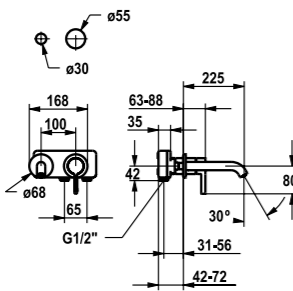

### BEVO LEVER MIXER BASIN TAP - BLACK

Iconic from every angle. A basin tap manufactured with a black finish, designed to meet the highest design standards. Timeless elegance in exceptional architecture. Features include:

KWC cartridge M 35 H with ceramic discs

Flow rate 5 l/min (3 bar)

Spout projection: 225 mm

**11.422.064.176** Lever mixer Black

**Mandatory Accessories:**

**39.001.401.931** Concealed unit

**Complimentary Accessories:**

**AT10-080** Soap dispenser - Black PVD coated

**AC17-047** TMV3



# Self closing and anti-block outlets

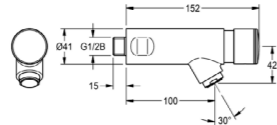

## F3S SELF-CLOSING BIB TAP

F3S self-closing DN 15 bib tap for sanitary facilities. Self-closing cartridge, hydraulically controlled, self-closing, adjustable flow duration. With anti-blocking system 2 (ABS2) for safety switch-off when permanently active. For connection to pre-mixed hot water or cold water. High-polished, chrome-plated brass housing. Aerator with an integrated flow rate controller 3.0 l/min

- F3SV1005** F3S Bib tap  
**Mandatory Accessories;**  
**AC17-047** TMV3  
**Complimentary Accessories;**  
**SD01-001** Wall mounted soap dispenser (chrome)

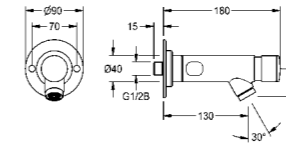

## F3S SELF-CLOSING BIB TAP WITH ANTI-BLOCK

F3S self-closing bib tap DN 15 with anti-twist protection for sanitary facilities. Especially suitable for facilities at risk of vandalism. Self-closing cartridge, hydraulically controlled, self-closing, adjustable flow duration and anti-blocking system 2 (ABS2) for safety switch-off in case of continuous operation. For connection to pre-mixed hot water or cold water. Rosette diameter 90 mm for visible front mounting, with anti-twist protection for bib tap and mounting material. All-metal construction, polished, chromium-plated brass. Anti-theft aerator with integrated flow regulator 6.0 l/min.

- F3SV1011** F3S Self-closing bib tap with anti-block  
**Complimentary accessories;**  
**SD300** Heavy duty wall mounted soap dispenser

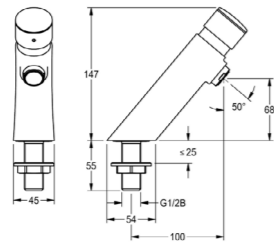

## F3S SELF-CLOSING PILLAR TAP WITH ANTI-BLOCK

F3S self-closing DN 15 pillartap for sanitary facilities. Self-closing cartridge, hydraulically controlled, self-closing, stepless adjustment of flow duration. With anti-blocking system 2 (ABS2) for safety switch-off when permanently active. For connection to pre-mixed hot water or cold water. High-polished, chrome-plated brass housing. Aerator with an integrated flow rate controller 3.0 l/min.

- F3SV1004** F3S self-closing pillar tap with anti-block  
**Mandatory Accessories;**  
**AC17-047** TMV3  
**Complimentary Accessories;**  
**SD110** Wall mounted soap dispenser

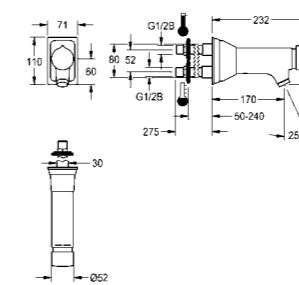

## SELF-CLOSING WALL-MOUNTED MIXER FOR REAR PANEL MOUNTING

F5S-Mix is a self-closing wall-mounted mixer with angled outlet, ideal for high-risk vandalism areas. It features FRAMIC self-closing mixer cartridge, ceramic disc technology, flow pressure-independent design, and adjustable temperature stop. It is made of polished, chromium-plated brass and comes with an anti-theft aerator with an integrated flow regulator. It can be connected to hot and cold water and is suitable for wall thicknesses from 50 to 240 mm.

- F5SM1012** Self-closing wall-mounted mixer  
**Complimentary accessories;**  
**SD300** Heavy duty wall mounted soap dispenser

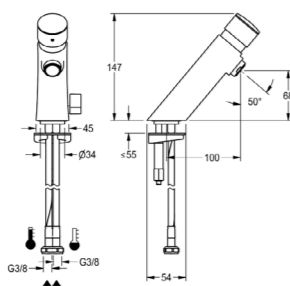

## F3S-MIX SELF-CLOSING PILLAR TAP WITH ANTI-BLOCK

F3S-Mix self-closing DN 15 pillar mixer for sanitary facilities. Self-closing cartridge, hydraulically controlled, self-closing, stepless adjustment of flow duration. With anti-blocking system 2 (ABS2) for safety switch-off when permanently active. For connection to hot and cold water via hoses with integrated non-return valves and strainers. Temperature lever with an adjustable turn-proof temperature stop. High-polished, chrome-plated brass housing. Aerator with an integrated flow rate controller 3.0 l/min.

- F3SM1008** F3S Mix self closing pillar mixer with anti-block  
**Mandatory Accessories;**  
**39.001.401.931** Concealed unit  
**Complimentary Accessories;**  
**AC00-030** Soap dispenser - stainless steel  
**AC17-047** TMV3

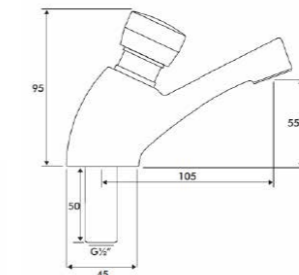

## NON CONVULSIVE TAP

The basin mounted push tap is designed for use with our range of thermostatic mixing valves. With a simple, non-convulsive operation and water saving technology this tap is ideal for use in areas such as leisure and commercial washrooms. The simple operation of the push tap enables users with limited mobility to use the facility. Supplied with red and blue indicator options.

- MT00-030** Non convulsive tap (single)  
**Complimentary Accessories;**  
**AC17-047** TMV3

# A SPLASH OF COLOUR

## PVD coated sensor taps



### THE KINGSWEAR

This range of modern, minimalistic and highly practical removable spouts are designed for the most demanding healthcare environments. The spout quickly and easily removes for servicing, ensuring minimal disruption. With a 316 Stainless Steel solid body, smooth flow channels and easy to clean shape, the Kingswear spout maintains high levels of hygiene to reduce cross contamination. The twist and lock mechanism ensures quick and easy removal of the kingswear spouts from the mounting spigot for efficient, disruption-free cleaning and maintenance. Available in gold, satin and black PVD coating.

**AT10-023** Kingswear 60 tap - Black

#### Mandatory accessories:

**AT00-221** Single station mains kit

**AC17-047** TMV3

**AT10-033** Programmable sensor - Black

### THE KINGSWEAR

This range of modern, minimalistic and highly practical removable spouts are designed for the most demanding healthcare environments. The spout quickly and easily removes for servicing, ensuring minimal disruption. With a 316 Stainless Steel solid body, smooth flow channels and easy to clean shape, the Kingswear spout maintains high levels of hygiene to reduce cross contamination. The twist and lock mechanism ensures quick and easy removal of the kingswear spouts from the mounting spigot for efficient, disruption-free cleaning and maintenance. Available in gold, satin and black PVD coating.

**AT10-025** Kingswear 60 tap - Gold

#### Mandatory accessories:

**AT00-221** Single station mains kit

**AC17-047** TMV3

**AT10-035** Programmable sensor - Gold

### THE KINGSWEAR

This range of modern, minimalistic and highly practical removable spouts are designed for the most demanding healthcare environments. The spout quickly and easily removes for servicing, ensuring minimal disruption. With a 316 Stainless Steel solid body, smooth flow channels and easy to clean shape, the Kingswear spout maintains high levels of hygiene to reduce cross contamination. The twist and lock mechanism ensures quick and easy removal of the kingswear spouts from the mounting spigot for efficient, disruption-free cleaning and maintenance. Available in gold, satin and black PVD coating.

**AT07-104** Kingswear 60 tap - Satin

#### Mandatory accessories:

**AT00-221** Single station mains kit

**AC17-047** TMV3

**AC02-021** Programmable sensor - Satin

### PROGRAMMABLE

Options include adjustable run-on times, sensor range, hygiene purges and more.

### COMPATIBLE

Programmable sensors are compatible with all DVS electronic taps, showers, WCs and urinals ranges.

### COLOURFUL

The sensors have been designed to match the range of colourful taps. Available in gold, satin and black with a brushed finish. The traditional stainless colour is also available.

### EFFICIENT

Real time data captured from the intelligent sensors can be uploaded using the DVS branded hand held programmer via the USB port. Allowing accurate monitoring of water efficiency.

### HYGIENIC

The sensors promote excellent hygiene in any washroom environment and are completely touch-free. A simple hand wave motion will activate the sensor.

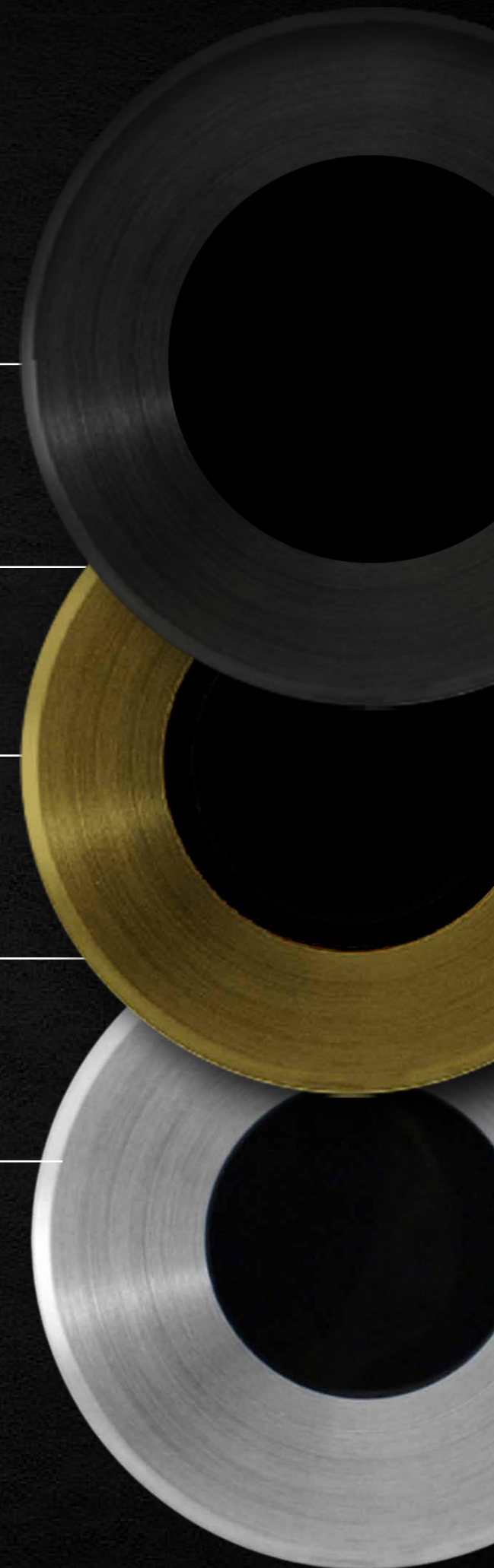

# F7 Taps



## F7 - PREVIEW 2024

### SEAMLESS STAINLESS STEEL WITH BLUETOOTH CONNECTIVITY

Our new F7 range is a first taste of the new, contactless design tap. Their minimalist, slender shape impresses with many innovative highlights. The opto-electronic sensor, in combination with an optional connectivity module, has a Bluetooth connection so that you can customise the settings using the Smart Connect App. The solid stainless steel housing with brushed surface has no joints or gaps, making it particularly hygienic and easy to clean.

F7E in 4 versions with and without mixer function and 2 sizes M and XL



F7E  
Electronic pillar tap (M)

F7EV1001 / 3600001255



F7E  
Electronic pillar tap (XL)

F7EV1002 / 3600001258



F7E-MIX  
Electronic pillar mixer (M)

F7EM1001 / 3600001257



F7E-MIX  
Electronic pillar mixer (XL)

F7EM1002 / 3600001259



Connectivity module

ACEX9020 / 3600001331

# Tap controls and accessories

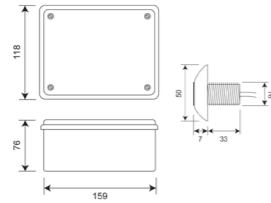

### TAP CONTROL SYSTEM – WAVE-ON

One or two station tap control system kit complete with wave on sensors. Designed to be wall mounted. Mains operated 230V. Ability to control valves for 1 or 2 spouts, or hot and cold valves for single spout. Manually adjustable setting options include run on times, hygiene purges and lock outs. Kit includes:

- AT07-001 Tap control system for 1 or 2 taps
- AC17-101 Anti-microbial plastic valve 12v DC
- AC02-013 50mm chrome wave on sensor with 3 metre cable

- AT07-010** Wave-on tap control system one station
- AT07-011** Wave-on tap control system two station

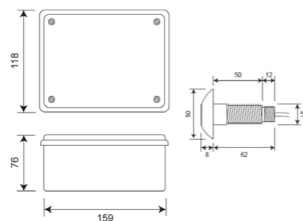

### TAP CONTROL SYSTEM – TACTILE

One or two station tap control system kit complete with tactile sensors. Designed to be wall mounted. Mains operated 230V. Ability to control valves for 1 or 2 spouts, or hot and cold valves for single spout. Manually adjustable setting options include run on times, hygiene purges and lock outs. Kit includes:

- AT07-001 Tap control system for 1 or 2 taps
- AC17-101 Anti-microbial plastic valve 12v DC
- AC02-046 Tactile switch with 50mmø stainless bezel & blue insert
- AC02-047 Tactile switch with 50mmø stainless bezel & red insert

- AT07-012** Tactile tap control system one station
- AT07-013** Tactile tap control system two station

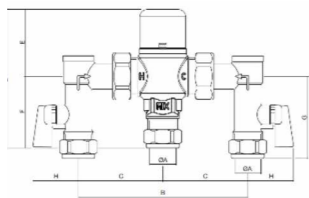

### THERMOSTATIC MIXING VALVE 4IN1 – 15/22MM

A highly advanced TMV3 approved thermostatic mixing valve for use in basin, shower, bidet and high pressure bath fill applications (above 1 bar). The valve is designed to control the mixed water outlet temperature to within +/- 2°C regardless of fluctuations in the temperature and pressure of the hot and cold water supplies. The valve will also shut the mixed water outlet instantly in case of hot or cold water failure

Factory temperature setting: 41-43°C – Temperature setting range: 38-46°C – Temperature, hot supply: 52-65°C – Temperature, cold supply: 5-20°C – Minimum hot to mix differential temperature: 10°C – Temperature stability: +/- 2°C – Working pressure, static: 16 bar max – Working pressure: 0.2-5 – Maximum pressure loss ratio: 10:1 – Flow rate, minimum: 4 lpm – Flow rate @ 1 bar pressure loss: 21 lpm

- AC17-047** Thermostatic Mixing Valve 4in1 – 15/22mm

NEW  
INFORM  
ENABLED

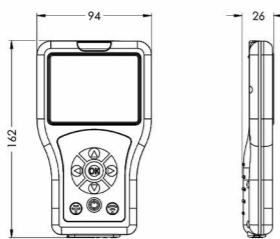

### HANDHELD PROGRAMMER

The Handheld Programmer allows quick and easy adjustment of settings including; run-on time, range, purge and more. Real time data can be uploaded from the programmer via the USB port to allow accurate monitoring of water efficiency. This programmer is compatible with the full range of programmable sensors and taps, including the F3 and F5 range.

Dimensions: 94 x 159 x 25mm

- AC01-001** Handheld programmer

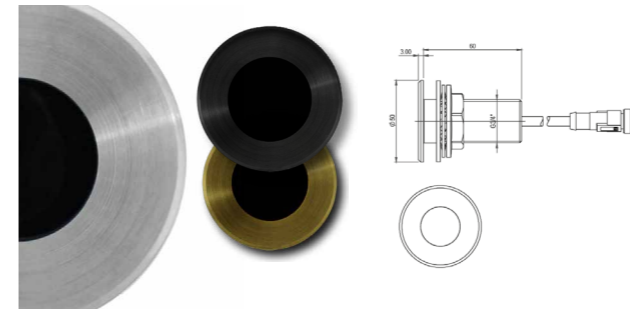

### KINGSWEAR PROGRAMMABLE TAP SENSORS

Kingswear range of programmable tap sensors compatible with the handheld programmer and the full Kingswear collection. The system allows for customisation of tap settings including sensor sensitivity, run-on times, anti-vandal lock-outs and hygiene flushing.

- AC02-017** Programmable tap sensor - Satin
- AT10-030** Programmable tap sensor - Black
- AT10-032** Programmable tap sensor - Gold
- AC01-001** Handheld programmer
- AC04-030** 6V water isolation system

No control box required, Suitable for use with the station kits listed below.

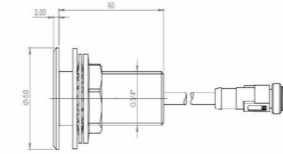
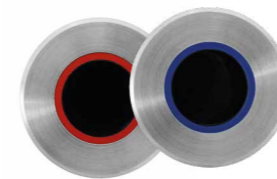

### PROGRAMMABLE TAP SENSORS

A range of programmable tap sensors compatible with the handheld programmer. The system allows for customisation of tap settings including sensor sensitivity, run-on times, anti-vandal lock-outs and hygiene flushing.

- AC02-017** Programmable tap sensor
- AC02-024** Blue (cold) programmable tap sensor
- AC02-025** Red (hot) programmable tap sensor
- AC01-001** Handheld programmer
- AC04-030** 6V water isolation system

No control box required, Suitable for use with the station kits listed below.



### ANTI-MICROBIAL STATION KITS

Anti-microbial station kits for touch-free outlets. Designed for standard pressure systems (1-7 BAR). The kit includes mains PSU and 6 Volt DC latching valve. All wetted parts are anti-microbial and Biomaster protected.

- AT00-220** Single station kit - Battery
- AT00-221** Single station kit - Mains
- AT00-222** Two station kit - Mains
- AT00-223** Three station kit - Mains

### LOW PRESSURE STATION KITS

- AT00-005** Single station battery kit low pressure - 0.5 - 1 BAR brass valve
- AT00-006** Single station mains kit low pressure - 0.5 - 1 BAR brass valve
- AT00-007** Two station mains kit low pressure - 0.5 - 1 BAR brass valve
- AT00-008** Three station mains kit low pressure - 0.5 - 1 BAR brass valve



## Washbasins and washtroughs

Discover the excellence of KWC DVS with our array of stainless steel and solid surface composite washbasins and washtroughs.

Our Miranit composite, solid surface basins offer a fusion of sleek lines and stylish aesthetics. Available in various sizes and shapes, these basins seamlessly integrate into public, semi-public or domestic spaces. Miranit is known for its durability, from the elegance of hotel bedrooms to the efficiency of stadia and airports, this material withstands the test of time. Its hard-wearing nature makes it a versatile choice suitable for an array of applications, sizes, and environments.

For high-traffic settings, KWC DVS stainless steel sinks prove their mettle. Boasting resilience and easy maintenance, these sinks minimise service costs whilst maintaining their pristine appearance.



**QUADRO single washbasin** –  
the distinctive shape of modern  
washroom design

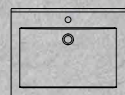

**QUADRO single washbasin ANMW411**  
600 x 530mm

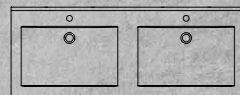

**QUADRO double washbasin ANMW421**  
1400 x 530mm

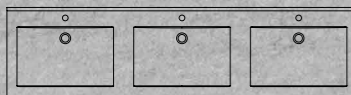

**QUADRO multiple washbasin ANMW431**  
2100 x 530mm

# QUADRO & RONDA

Distinctive shapes for a harmonious effect

The elegant circular shape of the RONDA washbasins was cut on a line running parallel to the wall. Its visually pleasing shape fits into any washroom and offers generous bowl space for cleaning. Its flat rear edge and an apron height of just 60mm, give the multiple wash systems a modern yet delicate appearance. The RONDA's timeless and appealing design makes it particularly attractive as a recessed washbasin.

**RONDA single washbasin**  
Elegant, delicate, modern

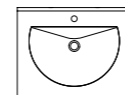

**RONDA single washbasin ANMW211**

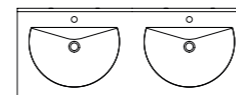

**RONDA double washbasin ANMW221**

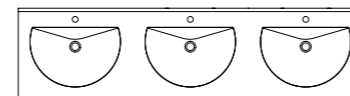

**RONDA multiple washbasin ANMW231**

All washbasins are also available without a tap hole.



# Washbasins and washtroughs

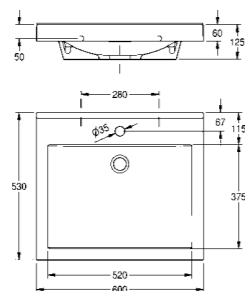

## QUADRO WASHBASIN WITH ONE TAP HOLE

QUADRO single washbasin made of MIRANIT resin-bonded mineral material, with smooth, pore-free surface (temperature-resistant up to 80 °C). Colour Alpine white. With seamless, rectangular bowl without overflow. Mounting on washbasin back panel. Rear contoured edge. Three-sided apron 60mm (H). Mounting material included.

Colour: Alpine white  
Without overflow  
Bowl dimensions: 520 x 90 (max depth) x 375mm  
Washbasin dimensions: 600 x 60 x 530mm

**ANMW410** Without tap holes

**ANMW411** With tap hole

**Mandatory accessories:**

**ZANMW900** Dome waste valve DN 32

**OR**

**ZANMW901** Strainer waste valve DN 32

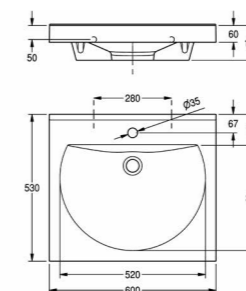

## RONDA SINGLE WASHBASIN

RONDA single washbasin made of MIRANIT resin-bonded mineral material with smooth and pore-free surface (temperature-resistant up to 80 °C). Colour Alpine white. With seamless round bowl, flattened out at the rear, without overflow. Mounting on washbasin back panel. Rear contoured edge. Three-sided apron 60mm (H). Mounting material included.

Colour: Alpine white  
Without overflow  
Bowl dimensions: 520 x 90 (max depth) x 380mm  
Washbasin dimensions: 600 x 60 x 530mm

**ANMW210** Without tap holes

**ANMW211** With tap hole

**Mandatory accessories:**

**ZANMW900** Dome waste valve DN 32

**OR**

**ZANMW901** Strainer waste valve DN 32

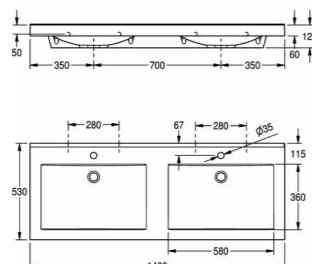

## QUADRO WASHBASIN WITH TWO TAP HOLES

QUADRO double washbasin made of MIRANIT resin-bonded mineral material, with smooth, pore-free surface (temperature-resistant up to 80 °C). Colour Alpine white. With seamless, rectangular bowl without overflow. Mounting on washbasin back panel. Rear contoured edge. Three-sided apron 60mm (H). Mounting material included.

Colour: Alpine white  
Without overflow  
Bowl dimensions: 580 x 90 (max depth) x 360mm  
Washbasin dimensions: 1400 x 60 x 530mm

**ANMW420** Without tap holes

**ANMW421** With tap holes

**Mandatory accessories:**

**ZANMW900** Dome waste valve DN 32

**OR**

**ZANMW901** Strainer waste valve DN 32

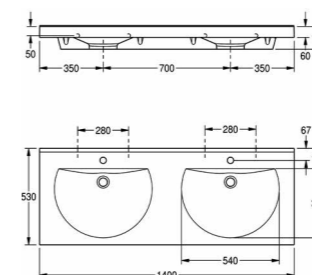

## RONDA DOUBLE WASHBASIN

RONDA double washbasins made of MIRANIT resin-bonded mineral material with smooth and pore-free surface (temperature-resistant up to 80 °C). Colour Alpine white. With seamless round bowl, flattened out at the rear, without overflow. Mounting on washbasin back panel. Rear contoured edge. Three-sided apron 60mm (H). Mounting material included.

Colour: Alpine white  
Without overflow  
Bowl dimensions: 540 x 90 (max depth) x 380mm  
Washbasin dimensions: 1400 x 60 x 530mm

**ANMW220** Without tap holes

**ANMW221** With tap holes

**Mandatory accessories:**

**ZANMW900** Dome waste valve DN 32

**OR**

**ZANMW901** Strainer waste valve DN 32

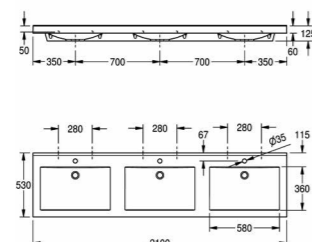

## QUADRO TRIPLE WASHBASIN

QUADRO triple washbasin made of MIRANIT resin-bonded mineral material, with smooth, pore-free surface (temperature-resistant up to 80 °C). Colour Alpine white. With seamless, rectangular bowl without overflow. Mounting on washbasin back panel. Rear contoured edge. Three-sided apron 60mm (H). Mounting material included.

Colour: Alpine white  
Without overflow  
Bowl dimensions: 580 x 90 (max depth) x 360mm  
Washbasin dimensions: 2100 x 60 x 530mm

**ANMW430** Without tap holes

**ANMW431** With tap holes

**Mandatory accessories:**

**ZANMW900** Dome waste valve DN 32

**OR**

**ZANMW901** Strainer waste valve DN 32

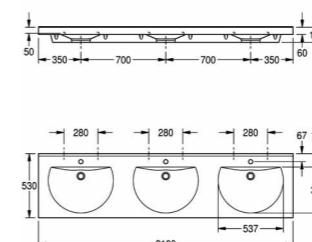

## RONDA TRIPLE WASHBASIN

RONDA triple washbasin made of MIRANIT resin-bonded mineral material with smooth and pore-free surface (temperature-resistant up to 80 °C). Colour Alpine white. With seamless round bowl, flattened out at the rear, without overflow. Mounting on washbasin back panel. Rear contoured edge. Three-sided apron 60mm (H). Mounting material included.

Colour: Alpine white  
Without overflow  
Bowl dimensions: 537 x 90 (max depth) x 380mm  
Washbasin dimensions: 2100 x 60 x 530mm

**ANMW230** Without tap holes

**ANMW231** With tap holes

**Mandatory accessories:**

**ZANMW900** Dome waste valve DN 32

**OR**

**ZANMW901** Strainer waste valve DN 32

# NEW Brixham solid surface washbasins

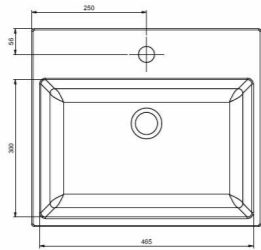

### BRIXHAM SQUARE WASHBASIN WITH TAP HOLE

The Brixham square countertop basin with one tap hole, is made of durable MIRANIT resin-bonded mineral material and has a pore-free surface that is easy to clean and maintain. It can withstand temperatures up to 80°C and has a seamless bowl design without an overflow. This basin is a great choice for those who want a hygienic and modern-looking option for their bathroom.

Colour: Beige

**SW00-103** Brixham square basin 500x430x160mm

**Mandatory accessories:**

**SW00-044** 1 1/4" Plastic bottle trap

**SW00-049** 1 1/4" Strainer waste - unslotted

OR

**ZANMW900** 1 1/4" Dome waste - Chrome

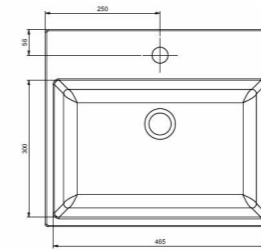

### BRIXHAM SQUARE WASHBASIN WITH TAP HOLE

The Brixham square countertop basin with one tap hole, is made of durable MIRANIT resin-bonded mineral material and has a pore-free surface that is easy to clean and maintain. It can withstand temperatures up to 80°C and has a seamless bowl design without an overflow. This basin is a great choice for those who want a hygienic and modern-looking option for their bathroom.

Colour: Schwartz Black

**SW00-102** Brixham square basin 500x430x160mm

**Mandatory accessories:**

**SW00-044** 1 1/4" Plastic bottle trap

**SW00-049** 1 1/4" Strainer waste - unslotted

OR

**ZANMW900** 1 1/4" Dome waste - Chrome

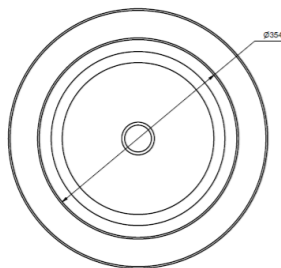

### BRIXHAM CIRCULAR WASHBASIN

The Brixham circular countertop basin is made of durable MIRANIT resin-bonded mineral material and has a pore-free surface that is easy to clean and maintain. It can withstand temperatures up to 80°C and has a seamless bowl design without an overflow. This basin is a great choice for those who want a hygienic and modern-looking option for their bathroom.

Colour: Beige

**SW00-101** Brixham circular basin diameter 465mm

**Mandatory accessories:**

**SW00-044** 1 1/4" Plastic bottle trap

**SW00-049** 1 1/4" Strainer waste - unslotted

OR

**ZANMW900** 1 1/4" Dome waste - Chrome

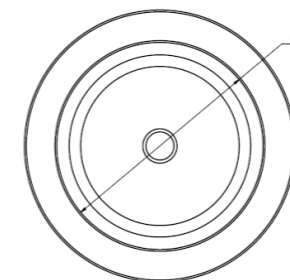
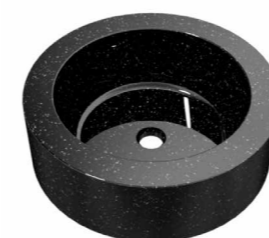

### BRIXHAM CIRCULAR BASIN

The Brixham circular countertop basin is made of durable MIRANIT resin-bonded mineral material and has a pore-free surface that is easy to clean and maintain. It can withstand temperatures up to 80°C and has a seamless bowl design without an overflow. This basin is a great choice for those who want a hygienic and modern-looking option for their bathroom.

Colour: Schwartz Black

**SW00-100** Brixham circular basin diameter 465mm

**Mandatory accessories:**

**SW00-044** 1 1/4" Plastic bottle trap

**SW00-049** 1 1/4" Strainer waste - unslotted

OR

**ZANMW900** 1 1/4" Dome waste - Chrome

# Washbasins and washtroughs

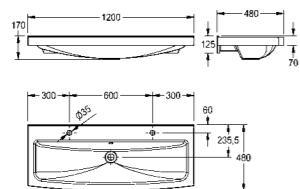

## 2 PERSON MIRANIT WASHTROUGH WITH TAP HOLES

Made from Miranit resin bonded mineral material, with an alpine white, smooth gelcoat surface temperature resistant up to 80°C. The seamlessly moulded trough and pore-free surface make the Miranit SOLX washtroughs extremely hygienic and easy to clean, whilst the fracture proof robust material makes them ideal for high usage areas. Integral back panel with brackets and fixing holes for wall mounting, and can either be left as a floating unit or integrated with vanity unit to hide pipework and plumbing materials. 32mm waste kit with overflow is included. Soap dispenser holes can be drilled upon request.

Dimensions: 1200 x 170 x 480mm

<b>SOLX1200T</b>	With 2 tap holes
<b>SOLX1200</b>	Without tap holes

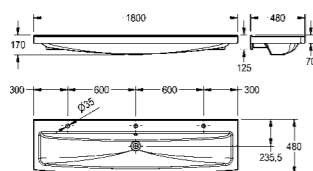

## 3 PERSON MIRANIT WASHTROUGH WITH TAP HOLES

Made from Miranit resin bonded mineral material, with an alpine white, smooth gelcoat surface temperature resistant up to 80°C. The seamlessly moulded trough and pore-free surface make the Miranit SOLX washtroughs extremely hygienic and easy to clean, whilst the fracture proof robust material makes them ideal for high usage areas. Integral back panel with brackets and fixing holes for wall mounting, and can either be left as a floating unit or integrated with vanity unit to hide pipework and plumbing materials. 32mm waste kit with overflow is included Soap dispenser holes can be drilled upon request.

Dimensions: 1800 x 170 x 480mm

<b>SOLX1800T</b>	With 3 tap holes
<b>SOLX1800</b>	Without tap holes

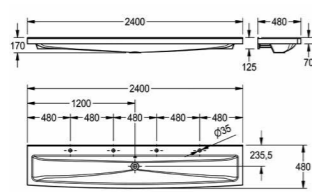

## 4 PERSON MIRANIT WASHTROUGH WITH TAP HOLES

Made from Miranit resin bonded mineral material, with an alpine white, smooth gelcoat surface temperature resistant up to 80°C. The seamlessly moulded trough and pore-free surface make the Miranit SOLX washtroughs extremely hygienic and easy to clean, whilst the fracture proof robust material makes them ideal for high usage areas. Integral back panel with brackets and fixing holes for wall mounting, and can either be left as a floating unit or integrated with vanity unit to hide pipework and plumbing materials. 32mm waste kit with overflow is included. Soap dispenser holes can be drilled upon request.

Dimensions: 2400 x 170 x 480mm

<b>SOLX2400T</b>	With 4 tap holes
<b>SOLX2400</b>	Without tap holes

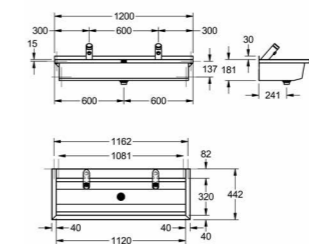

## 1200MM PLANOX WASHTROUGHS

PLANOX seamless welded washtrough for wall mounting, chromium nickel steel, satin finished surface, material thickness of washtrough 0.8mm / side panels 1.2mm, side panels with integrated wall brackets, lowered tap ledge 80mm, 40mm rear upstand, central waste, G 1 1/2 B strainer waste, includes mounting materials. Special lengths are available on request.

Soap dispenser holes can be drilled upon request  
Dimensions: 1200 x 210mm (W x H)

<b>PL12T-UK</b>	With 2 tap holes	442mm depth
<b>PL12-UK</b>	Without tap holes	382mm depth

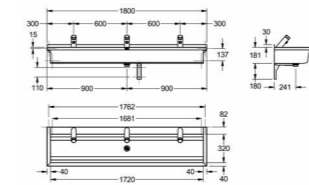

## 1800MM PLANOX WASHTROUGHS

PLANOX seamless welded washtrough for wall mounting, chromium nickel steel, satin finished surface, material thickness of washtrough 0.8mm / side panels 1.2mm, side panels with integrated wall brackets, lowered tap ledge 80mm, 40mm rear upstand, central waste, G 1 1/2 B strainer waste, includes mounting materials. For a length of 1800mm or more, an additional bracket is supplied. Special lengths are available on request.

Soap dispenser holes can be drilled upon request  
Dimensions: 1800 x 210mm (W x H)

<b>PL18T-UK</b>	With 3 tap holes	442mm depth
<b>PL18-UK</b>	Without tap holes	382mm depth

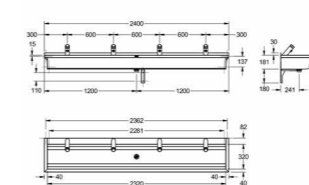

## 2400MM PLANOX WASHTROUGHS

PLANOX seamless welded washtrough for wall mounting, chromium nickel steel, satin finished surface, material thickness of washtrough 0.8mm / side panels 1.2mm, side panels with integrated wall brackets, lowered tap ledge 80mm, without tap holes or overflow, 40mm rear upstand, central waste, G 1 1/2 B strainer waste, includes mounting materials. For a length of 1800mm or more, an additional bracket is supplied. Special lengths are available on request.

Soap dispenser holes can be drilled upon request  
Dimensions: 2400 x 210mm (W x H)

<b>PL24T-UK</b>	With 4 tap holes	442mm depth
<b>PL24-UK</b>	Without tap holes	382mm depth

## OTHER SIZES ARE AVAILABLE

<b>PL6T-UK</b>	600mm with tap deck & 1 taphole
<b>PL6-UK</b>	600mm with no tap deck/taphole
<b>PL8T-UK</b>	800mm with tap deck and 1 taphole
<b>PL8-UK</b>	800mm with no tap deck/tapholes
<b>PL16T-UK</b>	1600mm with tap deck and 2 tapholes
<b>PL16-UK</b>	1600mm with no tap deck/tapholes
<b>PL30T-UK</b>	3000mm with tap deck and 5 tapholes
<b>PL30-UK</b>	3000mm with no tap deck/tapholes

## SPARE SHROUDS

<b>PL-SHROUD LRG</b>	Trap shroud for Planox troughs with tap deck
<b>PL-SHROUD SML</b>	Trap shroud for Planox troughs without tap deck

Leg underframes available upon request

# Washbasins and washtroughs

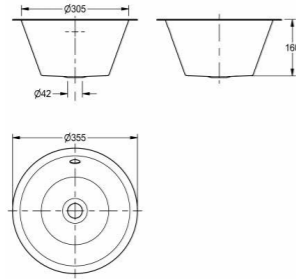

## SISSONS ROUND 305MM RIMMED EDGE INSET WASH BASIN

Round 305mm diameter rimmed edge inset wash basin. Manufactured from 1.2mm thick grade 1.4301 (304) stainless steel. Prepared for 32mm waste outlet and overflow. Designed with no tap holes therefore taps can be fitted through the worktop or wall mounted. Supplied with fixing adhesive. Waste kit sold separately.

Dimensions: 355 x 160 x 355mm

- D20140N** Inset wash basin
- Mandatory accessories:**
- F2117** 32mm waste, plug, chain and overflow
- Complimentary accessories:**
- F6005** Overflow stopper

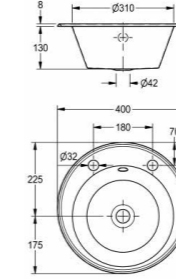

## SISSONS 310MM INSET WASH BASIN WITH TAP LANDING

310mm diameter inset wash basin with tap landing Inset hand washbasin which can be mounted from top or underneath. Manufactured from 1.2mm thick grade 1.4301 (304) stainless steel. Prepared for 32mm waste outlet and overflow hole with two tap holes in the rear ledge behind the bowl - suitable for basin taps only (deck mixers cannot be fitted). Supplied with fixing clips for inseting into worktops. Waste kit sold separately

Satin finished  
Bowl Dimensions: 310 dia. x 160mm depth  
Dimensions: 400 x 138 x 400mm

- D20170N** Inset wash basin
- Mandatory accessories:**
- F2117** 32mm waste, plug, chain and overflow
- F1329N** Lever basin taps
- F1080N** Crosshead basin taps

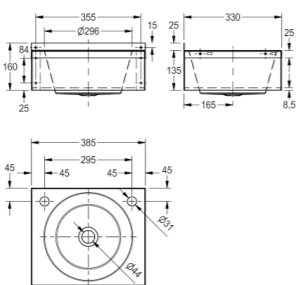

## SISSONS MODEL B 290MM WALL MOUNTED WASHBASIN WITH APRON

Model B 290mm diameter wall mounted washbasin with apron. Manufactured from 0.9mm thick grade 1.4301 (304) stainless steel with a high polished finish. The basin is prepared for 32mm waste outlet and is supplied with two tap holes in the rear ledge, and an overflow. The basin is wall mounted using the fixing holes provided in both the rear up-stand and the rear apron fixing brackets for extra security. Screws and plugs are not supplied.

Dimensions: 340 x 185 x 345mm

- D20162N** Wash basin
- Mandatory accessories:**
- F1329N** Lever basin taps
- F1080N** Crosshead basin taps

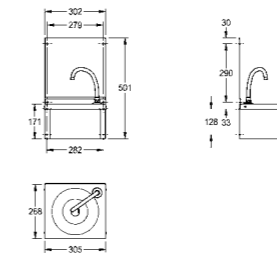

## ANIMA KNEE OPERATED WASHBASIN

Knee operated wash hand basin is manufactured from stainless steel - satin polish finish, material thickness 0.9mm. Supplied complete with water spout positioned in rear right hand corner and 32mm waste outlet. Note: The pre-mixing valve and the pipework linking the water spout to the knee operated front panel is all supplied with the washbasin. Wall mounted by fitting a top joggle strip under the upstand return and by screw fixing through the integral rear brackets. Screws and plugs are not supplied.

- ANMX212N** 338 x 535 x 343mm
- OR**
- ANMX216** 305 x 501 x 268mm

IMAGE AND DRAWING ILLUSTRATES ANMX216 VERSION.

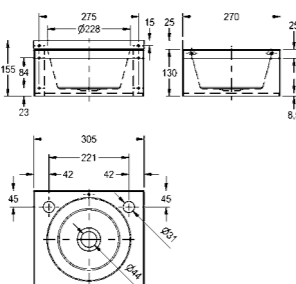

## SISSONS MODEL A 240MM WALL MOUNTED WASHBASIN WITH APRON

Model a 240mm diameter wall mounted washbasin with apron. Manufactured from 0.9mm thick grade 1.4301 (304) stainless steel with a high polished finish. The basin is prepared for 32mm waste outlet and is supplied with two tap holes in the rear ledge, without an overflow. The basin is wall mounted using the fixing holes provided in both the rear up-stand and the rear apron fixing brackets for extra security. Screws and plugs are not supplied.

Dimensions: 290 x 157 x 290mm

- D20161N** Wash basin
- Mandatory accessories:**
- F1329N** Lever basin taps
- F1080N** Crosshead basin taps

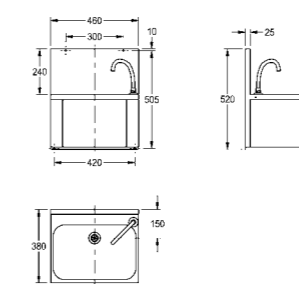

## ANIMA KNEE OPERATED WASHBASIN

Knee operated wash hand basin is manufactured from stainless steel-satin polish finish, material thickness 0.9mm. Supplied complete with water spout positioned in rear right hand corner and 32mm waste outlet. Note: The pre-mixing valve and the pipework linking the water spout to the knee operated front panel is all supplied with the washbasin. Wall mounted by fitting a top joggle strip under the upstand return and by screw fixing through the integral rear brackets. Screws and plugs are not supplied.

- ANMX206** 420 x 520 x 380mm

# Circular washtroughs

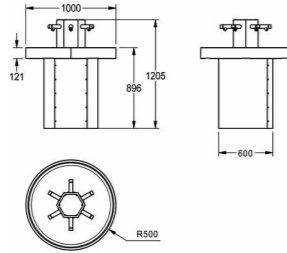

### SISSONS 6 PERSON CIRCULAR WASHTROUGH

Highly durable and water efficient circular washtrough designed to withstand intensive use in a busy environment. This 6 person circular washtrough is supplied with either self-closing or electronic taps which are designed to save water through the adjustable flow time function. The large floor mounted base provides good stability, and the services are fed from below and can be accessed through a side panel which are fitted with tamper proof security screws. The use of a single water supply and waste has a significant cost saving compared to conventional washbasins which need a water supply and waste for each basin. Delivered fully assembled.

Floor supply services  
 Finish: Satin polished  
 Taps: 6 taps  
 Dimensions: 1000 x 1205 x 1000mm

**SANX600** With self-closing taps  
**SANX610** With electronic taps

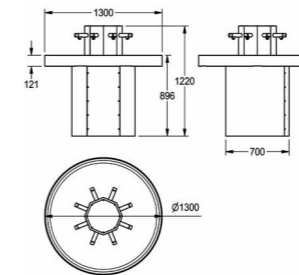

### SISSONS 8 PERSON CIRCULAR WASHTROUGH

Highly durable and water efficient circular washtrough designed to withstand intensive use in a busy environment. This 8 person circular washtrough is supplied with either self-closing or electronic taps which are designed to save water through the adjustable flow time function. The large floor mounted base provides good stability, and the services are fed from below and can be accessed through a side panel which are fitted with tamper proof security screws. The use of a single water supply and waste has a significant cost saving compared to conventional washbasins which need a water supply and waste for each basin. Delivered fully assembled.

Floor supply services  
 Finish: Satin polished  
 Taps: 8 taps  
 Dimensions: 1300 x 1220 x 1300mm

**SANX800** With self-closing taps  
**SANX810** With electronic taps

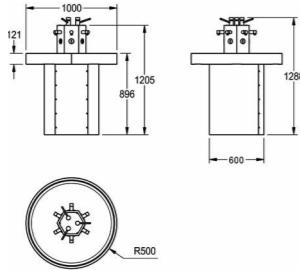

### SISSONS 6 PERSON CIRCULAR WASHTROUGH WITH SOAP DISPENSERS

Highly durable and water efficient circular washtrough designed to withstand intensive use in a busy environment. This 6 person circular washtrough is supplied with either self-closing or electronic taps and self-closing soap dispensers. The large floor mounted base provides good stability, and the services are fed from below and can be accessed through a side panel which are fitted with tamper proof security screws. The use of a single water supply and waste has a significant cost saving compared to conventional washbasins which need a water supply and waste for each basin. Delivered fully assembled.

Floor supply services  
 Finish: Satin polished  
 Taps: 6 taps  
 With soap dispensers  
 Dimensions: 1000 x 1205 x 1000mm

**SANX605** With self-closing taps  
**SANX615** With electronic taps

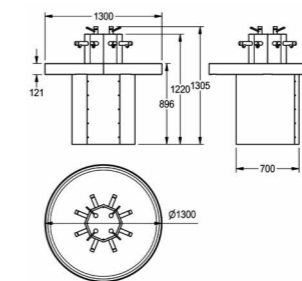

### SISSONS 8 PERSON CIRCULAR WASHTROUGH WITH SOAP DISPENSERS

Highly durable and water efficient circular washtrough designed to withstand intensive use in a busy environment. This 8 person circular washtrough is supplied with either self-closing or electronic taps and self-closing soap dispensers. The large floor mounted base provides good stability, and the services are fed from below and can be accessed through a side panel which are fitted with tamper proof security screws. The use of a single water supply and waste has a significant cost saving compared to conventional washbasins which need a water supply and waste for each basin. Delivered fully assembled.

Floor supply services  
 Finish: Satin polished  
 Taps: 8 taps  
 With soap dispensers  
 Dimensions: 1300 x 1220 x 1300mm

**SANX805** With self-closing taps  
**SANX815** With electronic taps

# Ceramic washbasins

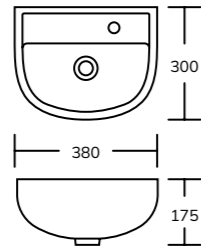

## WALL HUNG CERAMIC BASIN 380MM

San Ceram wall hung basin manufactured from Vitreous china with an alpine white finish. Designed with a right hand tap hole and is ideal where space is constraint. Complete without overflow and fixings for installation.

Doc M, HBN & HTM Compliant  
Dimensions: 380 x 175 x 300mm

- SW00-047** Basin with right hand tap hole
- SW00-048** Basin with left hand tap hole
- Mandatory accessories:**
- SW00-044** 1 1/4" Plastic bottle trap
- SW00-049** 1 1/4" Strainer waste - unslotted
- OR**
- SW00-050** 1 1/4" Press top waste - unslotted

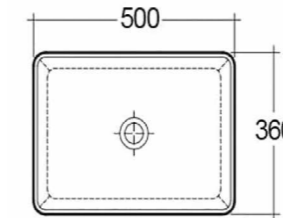

## RECTANGULAR LANGLEY BASIN

Rectangular basin manufactured from Vitreous china to BS 3402. Designed to fit any washroom space whether it be contemporary or traditional. With a slim sided appearance, no tap holes or overflow. For installation onto a vanity or worktop. Bottom outlet for ease of maintenance.

Dimensions: 500 x 145 x 360mm

- SW00-066** Rectangular basin
- Mandatory accessories:**
- SW00-044** 1 1/4" Plastic bottle trap
- SW00-049** 1 1/4" Strainer waste - unslotted
- OR**
- SW00-050** 1 1/4" Press top waste - unslotted
- Complimentary accessories:**
- AT03-041** Aquarius high neck tap with PEX hose (15mm)
- AT00-220** Single station kit - battery

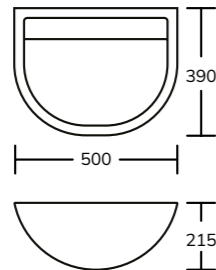

## WALL HUNG CLINICAL BASIN 500MM

Clinical wall hung basin, manufactured from Vitreous china with an alpine white finish. Designed without tap holes and overflow. Back outlet for increased infection prevention.

HBN & HTM Compliant  
Dimensions: 500 x 215 x 390mm

- SW00-042** Clinical basin
- Mandatory accessories:**
- SW00-044** 1 1/4" Plastic bottle trap
- SW00-043** Hangers and waste adaptor

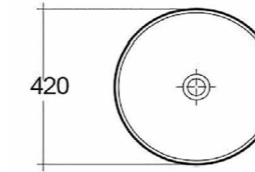

## CIRCULAR LANGLEY BASIN

Circular basin manufactured from Vitreous china to BS 3402. Designed to fit any washroom space whether it be contemporary or traditional. With a slim sided appearance, no tap holes or overflow. For installation onto a vanity or worktop. Bottom outlet for ease of maintenance.

Dimensions: 420 x 130 x 420 xmm

- SW00-067** Circular basin
- Mandatory accessories:**
- SW00-044** 1 1/4" Plastic bottle trap
- SW00-049** 1 1/4" Strainer waste - unslotted
- OR**
- SW00-050** 1 1/4" Press top waste - unslotted
- Complimentary accessories:**
- AT03-041** Aquarius high neck tap with PEX hose (15mm)
- AT00-220** Single station kit - battery

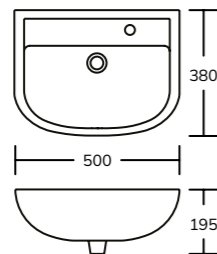

## WALL HUNG CERAMIC BASIN WITH TAP HOLE 500MM

San Ceram wall hung basin manufactured from Vitreous china with an alpine white finish. Designed with a right hand tap hole and is ideal where space is a constraint. Complete without overflow and fixings for installation.

Doc M, HBN & HTM Compliant  
Dimensions: 500 x 195 x 380mm

- SW00-045** Clinical basin with right hand tap hole
- Mandatory accessories:**
- AT03-021** Aquarius 45° spout with With PEX hoses
- SW00-044** 1 1/4" Plastic bottle trap
- SW00-049** 1 1/4" Strainer waste - unslotted

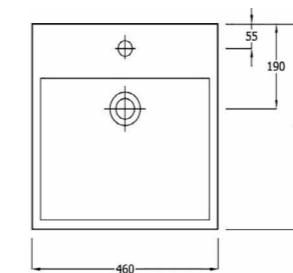

## MARDEN SQUARE 460 BASIN CTH

Our SanCeram Marden Square 460mm Basin features a sleek and minimalistic design, perfect for modern washrooms. It comes with a central tap hole and an overflow for added convenience. The basin includes Fisher fixings for easy installation and can be mounted on a vanity or wall hung. Its bottom outlet ensures easy maintenance as well.

Dimensions: 460 x 460 x 150mm

- SW00-072** Marden square counter top 460 CTH
- Mandatory accessories:**
- SW00-044** 1 1/4" Plastic bottle trap
- SW00-049** 1 1/4" Strainer waste - unslotted
- OR**
- SW00-050** 1 1/4" Press top waste - unslotted
- SW00-043** Hangers and waste adaptor

# Ceramic washbasins

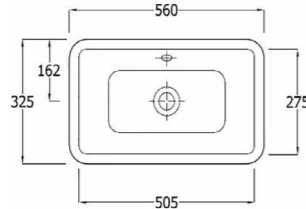

## MARDEN 560MM BASIN

Marden 560mm Under Mounted Basin with no taps. The basin rim is glazed also allowing this basin to be installed as an inset countertop basin. Requires external overflow adaptor.

Doc M, HBN & HTM Compliant  
Dimensions: 560 x 275 x 135mm

**SW00-093** Basin with right hand tap hole

**Mandatory accessories:**

**SW00-044** 1 1/4" Plastic bottle trap

**SW00-049** 1 1/4" Strainer waste - unslotted

**OR**

**SW00-050** 1 1/4" Press top waste - unslotted

**Complimentary accessories:**

**AT03-021** Aquarius 45° spout with With PEX hose

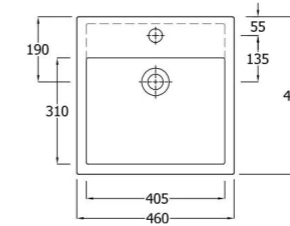

## MARDEN SQUARE SEMI-RECESSED BASIN 460 CTH

Marden square 460mm Semi-recessed Basin with overflow and central tap hole for installation into a vanity top.

Dimensions: 460 x 460 x 150mm

**SW00-097** Square semi-recessed basin 460 CTH

**Mandatory accessories:**

**SW00-044** 1 1/4" Plastic bottle trap

**SW00-049** 1 1/4" Strainer waste - unslotted

**OR**

**SW00-050** 1 1/4" Press top waste - unslotted

**Complimentary accessories:**

**AT03-061** Aquarius high neck tap with PEX hose (15mm)

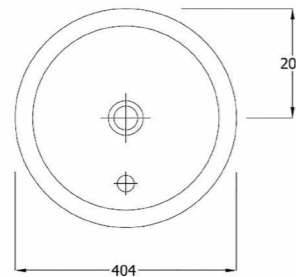

## LANGLEY 400MM BASIN

Langley 400mm Under Counter Basin with no tap holes. The basin rim is glazed allowing the basin to also be installed as an inset countertop basin. Requires an external overflow adaptor

Doc M, HBN & HTM Compliant  
Dimensions: 404 x 404 x 195mm

**SW00-092** Basin with left hand tap hole

**Mandatory accessories:**

**SW00-044** 1 1/4" Plastic bottle trap

**SW00-049** 1 1/4" Strainer waste - unslotted

**OR**

**SW00-050** 1 1/4" Press top waste - unslotted

**Complimentary accessories:**

**AT03-021** Aquarius 45° spout with With PEX hoses

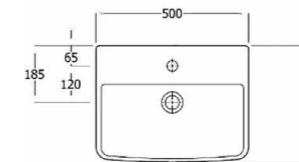

## LANGLEY SEMI-RECESSED BASIN

Langley 500mm semi-recessed basin with central tap hole, for installation into a semi-recessed vanity unit.

Dimensions: 500 x 380 x 140mm

**SW00-096** Semi-recessed basin 500 CTH

**Mandatory accessories:**

**SW00-049** 1 1/4" Strainer waste - unslotted

**OR**

**SW00-050** 1 1/4" Press top waste - unslotted

**Complimentary accessories:**

**AT03-061** Aquarius high neck tap with PEX hose (15mm)

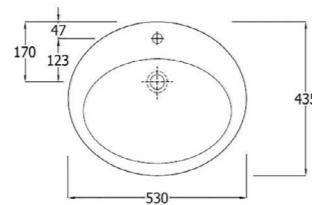

## CHARTHAM 530 BASIN

Chartham 530mm countertop basin with central tap hole is the ideal addition to any modern washroom.

Doc M, HBN & HTM Compliant  
Dimensions: 530 x 435 x 225mm

**SW00-114** Basin with right hand tap hole

**Mandatory accessories:**

**SW00-044** 1 1/4" Plastic bottle trap

**SW00-049** 1 1/4" Strainer waste - unslotted

**Complimentary accessories:**

**AT03-021** Aquarius 45° spout with With PEX hoses

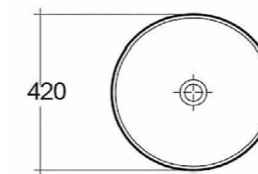

## CHARTHAM SEMI-RECESSED BASIN 450 RHTH

Chartham 450mm Semi-recessed basin with right hand tap hole offers a sleek, easy to clean modern design.

Dimensions: 450 x 360 x 185mm

**SW00-098** Semi-recessed basin 450 RH

**Mandatory accessories:**

**SW00-049** 1 1/4" Strainer waste - unslotted

**OR**

**SW00-050** 1 1/4" Press top waste - unslotted

**Complimentary accessories:**

**AT03-041** Aquarius high neck tap with PEX hose (15mm)

KWC

KWC

KWC

KWC

SOAP



WATER



AIR



SOAP



WATER



AIR



## Glacier all-in-one Mirror System

Say goodbye to traditional hand washing stations and hello to a revolution in restroom technology. Our cutting-edge Glacier all-in-one mirror system combines elegance, efficiency and innovation to transform the way you experience public restrooms.

The Glacier range offers a perfect fit for any design, effortlessly blending into your space. Whether it's a singular unit and basin or multiple systems side by side, the sleek design complements all washroom types. Upgrade your restroom to a new level of sophistication and convenience. Experience the magic of the all-in-one Glacier mirror system and elevate your establishments restroom experience like never before.



# GLACIER - Customise your options in six steps

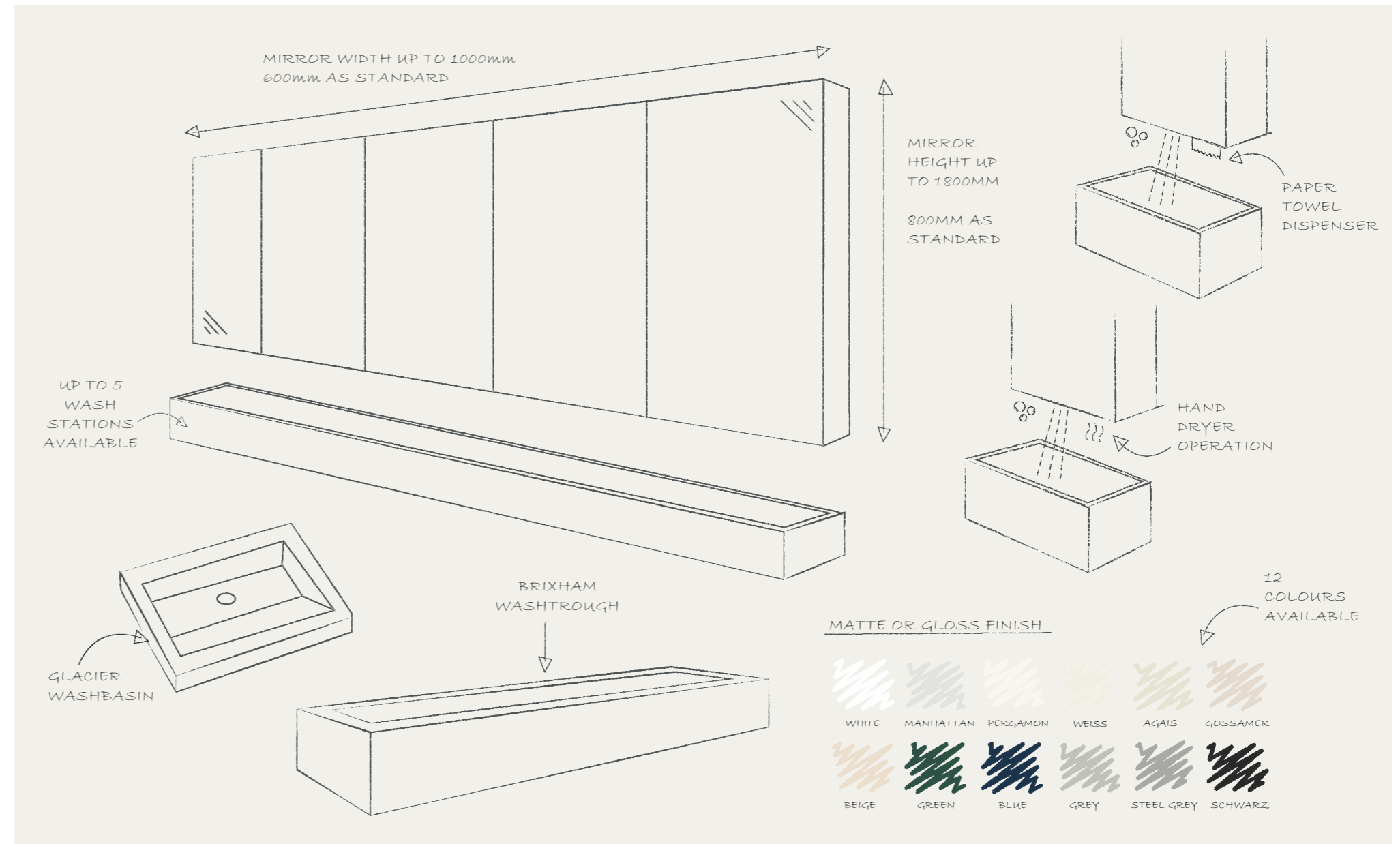

## 1. Choose your mirror set up

Choose between soap, water, air or soap, water, paper depending on requirements. For those who prefer a classic approach, the Glacier unit can be equipped with a paper towel dispenser. Alternatively, the Glacier can incorporate a touch-free hand dryer. Both options are complemented by a built-in soap dispenser and a tap, providing a complete handwashing experience in one convenient location.

## 2. Basin style

Elevate your restroom with our Brixham Corian Washtrough's sleek durability or the Square Glacier Miranit Wash Basin's contemporary style. Corian offers lasting elegance, while Miranit boasts minimalist appeal. Choose the basin that matches your aesthetic and functional needs, and upgrade your restroom with sophistication and durability.

## 3. Number of washplaces

Once you have chosen a basin style, customise your restroom with our flexible washplace options, accommodating from one to five basins to suit any space or traffic volume.

Tailor your layout for efficiency and style, ensuring your restroom meets your specific needs without compromise.

## 4. Mirror width and height

After finalising functionality, style, and basin quantity, customise the width and height of your Glacier Unit to perfectly fit your washroom.

Tailor the dimensions precisely to your space, ensuring seamless integration and maximising efficiency. Design your ideal washroom setup with confidence and precision for a flawless result.

## 5. Colour and finish

Select the perfect colour and finish for your washbasin(s) from our range of 12 standard options, available in high gloss or matte finishes. From classic neutrals to vibrant hues, customise your washroom aesthetic effortlessly.

For full colour options, see page 64..

## 6. Integrate accessories

Complete your Glacier solution by incorporating an integrated waste bin option, seamlessly blending functionality with elegance. Choose between circular and square designs to complement your restroom's aesthetic seamlessly. Keep your space tidy and organised while maintaining a cohesive look with this essential addition.

# GLACIER - Custom solutions for any space

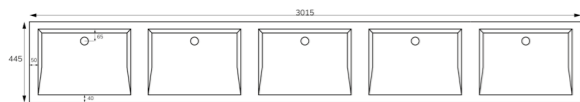
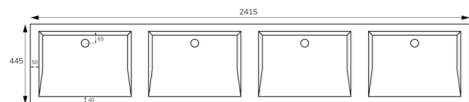
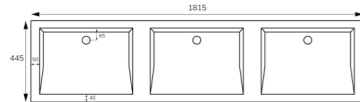
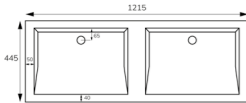
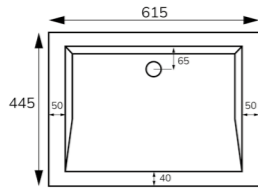
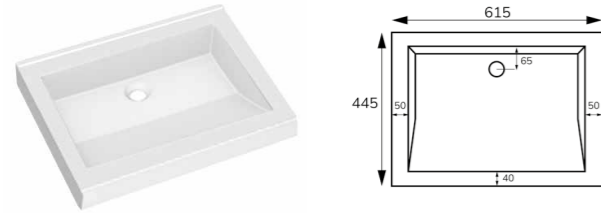

## GLACIER WASHBASINS

Washbasins made of MIRANIT resin-bonded mineral material, with smooth, pore-free surface (temperature-resistant up to 80 °C). Standard colour Alpine white (other options available). With seamless, rectangular bowl without overflow. Mounting on washbasin back panel. Rear contoured edge. Three-sided apron 60mm (H). Mounting material included. Mounting material included.

Colour: Alpine white standard (see colours below which are available upon request)

With overflow

Supply with brackets and fixings

Continuous flow drain outlet

Bowl dimensions: 515 x 365mm

<b>GL60</b>	Single bowl	615mm wide
<b>GL120</b>	Two bowls	1215mm wide
<b>GL180</b>	Three bowls	1815mm wide
<b>GL240</b>	Four bowls	2415mm wide
<b>GL300</b>	Five bowls	3015mm wide

**BESPOKE OPTIONS INCLUDING COLOURS, VANITY UNITS AND UP TO 10 BASINS ARE AVAILABLE, PLEASE GET IN TOUCH FOR MORE DETAILS AND FULL SPECIFICATION.**

## OPTIONS AVAILABLE IN GLOSS OR MATTE



## BRIXHAM WASHTROUGHS

Washtroughs manufactured from solid surface material in white. Designed to be wall mounted and used in conjunction with wall mounted taps. Single left handed 1 1/2" waste outlet point. Various width options available. Various width options available designed to complement our Glacier mirror system (600mm wide per unit).

Suitable for use with Glacier mirror unit range (see page 112)

Cantilever Brackets required (see below)

No Overflow

Flat bottom trough design

Vanity units available upon request

<b>SW00-068</b>	1200mm wide	Suitable for 2 mirror system
<b>SW00-069</b>	1800mm wide	Suitable for 3 mirror system
<b>SW00-070</b>	2400mm wide	Suitable for 4 mirror system
<b>SW00-071</b>	3000mm wide	Suitable for 5 mirror system
<b>SW00-075</b>	1 x Cantilever bracket	

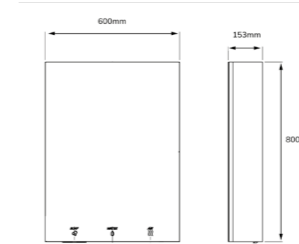
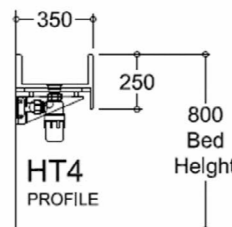

## NEW FOR 2024

### GLACIER MIRROR UNIT - SOAP, WATER, AIR

Elevate your washroom's aesthetic with our seamless and contemporary mirror systems. The Glacier range offers a perfect fit for any design, effortlessly blending into your space. Whether it's a singular unit and basin or multiple systems side by side, the sleek design complements all washroom types.

With each mirror measuring 600mm wide, our designs are crafted to achieve a seamless look. Embrace the clean lines and sophisticated appeal as these mirrors effortlessly enhance your washroom's ambiance. Upgrade your washroom with the Glacier range and experience the fusion of modernity and simplicity. Let your space shine with these elegantly crafted mirror systems, creating a polished and cohesive look like never before.

Paper towel and hand dryer version available

Dimensions: 600 x 800 x 153mm

Soap capacity: 2.2L

### GLSWA60 SOAP, WATER, AIR

Custom options available please contact our team for more details

## NEW FOR 2024

### GLACIER MIRROR UNIT - SOAP, WATER, PAPER

Elevate your washroom's aesthetic with our seamless and contemporary mirror systems. The Glacier range offers a perfect fit for any design, effortlessly blending into your space. Whether it's a singular unit and basin or multiple systems side by side, the sleek design complements all washroom types.

With each mirror measuring 600mm wide, our designs are crafted to achieve a seamless look. Embrace the clean lines and sophisticated appeal as these mirrors effortlessly enhance your washroom's ambiance. Upgrade your washroom with the Glacier range and experience the fusion of modernity and simplicity. Let your space shine with these elegantly crafted mirror systems, creating a polished and cohesive look like never before.

Paper towel and hand dryer version available

Dimensions: 600 x 800 x 153mm

Soap capacity: 2.2L

### GLSWP60 SOAP, WATER, PAPER

Custom options available please contact our team for more details

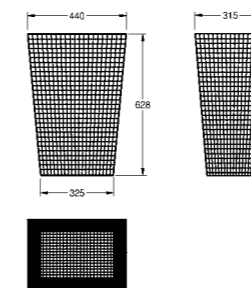
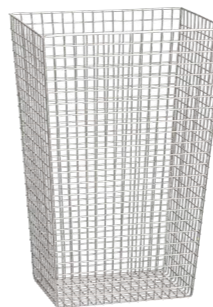

## GLACIER WASTE BIN

Glacier waste bin free standing or for wall mounting, stainless steel, surface satin finished, wire thickness 2 mm, square perforated facia pattern, includes stainless steel screws and dowels. Can be mounted under customised Brixham or Glacier solid surface washbasins that have a pre-cut hole for concealed and hygienic paper towel disposal.

Dimensions 440 x 628 x 315 mm (W x H x D)

### CHRX607 Waste bin



## Clinical outlets

The range of clinical outlets from KWC DVS have been designed to excel in healthcare settings where water hygiene is paramount. The range of taps assist with maintaining water temperatures above bacteria thriving thresholds, drastically reducing infection risks. With a focus on infection prevention, our TDV taps ensure peace of mind for facility managers, healthcare professionals, and users alike. Experience the confidence and benefits of using our thermal disinfection tap range.

# Clinical outlet solutions

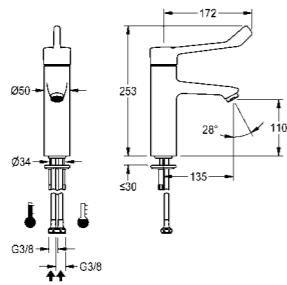

### F4LT-MED THERMOSTATIC SINGLE LEVER MIXER

F4LT-Med thermostatic single lever mixer as DN 15 pillar mixer for sanitary facilities in the healthcare and nursing sector, lever length 172mm. Thermostat-controlled mixer cartridge with expansion element and active scald protection, fail-safe against backflow, as well as adjustable and turn-proof temperature stop, and ceramic disc technology. With backflow preventer for optimised drinking water hygiene. Lever cap ergonomically designed in closed construction for contactless lever actuation. For connection to hot water and cold water via pipes, includes strainers. Tap optimised for cleaning, all-metal construction, polished chromium-plated low-lead brass (lead proportion ≤ 0.2%), with volume-reduced water flow without nickel coating. Laminar jet controller with integrated flow rate controller 8.0 l/min, projection 135mm.

**F4LT1011** F4LT-MED thermostatic single lever mixer

**Complimentary accessories:**

**SW00-045** Wall hung clinical basin 500mm RH tap hole

**SW00-043** Hangers & waste adaptor

**SW00-044** 1 1/4" Plastic bottle trap

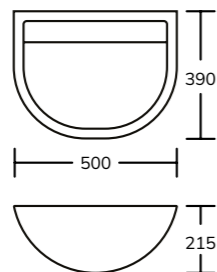

### WALL HUNG CLINICAL BASIN 500MM

Clinical wall hung basin, manufactured from Vitreous china with an alpine white finish. Designed without tap holes and overflow. Back outlet for increased infection prevention.

HBN & HTM COMPLIANT

Dimensions: 500 X 215 X 390mm

**SW00-042** Clinical basin

**SW00-045** Clinical basin right hand tap hole

**Mandatory accessories:**

**SW00-044** 1 1/4" Plastic bottle trap

**SW00-043** Hangers and waste adaptor

### THERMAL DISINFECTION VALVE

The KWC DVS thermal disinfection valve has been designed to aid the prevention of biofilm, reducing the risk of water-borne pathogens by allowing thermal disinfection from the TMV through to the outlet (1 x TDV is required per TMV). The valve is suitable for taps, showerheads and other washroom equipment fitted with a TMV.

Features include:

Reduces risk of water-borne pathogens, Simple, single-quarter turn operation, Integral non-return valves to prevent backflow, Corrosion-resistant DZR brass body, Suitable for 22mm and 15mm pipework, Compliant with water regulations and by-laws and WRAS approved.

**AC17-080** Thermal Disinfection Valve

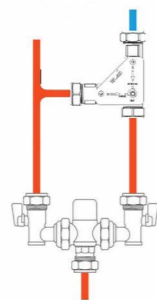

NEW  
**INFORM**  
ENABLED



### INFORM CLINICAL OUTLET

INFORM clinical outlet manufactured in 316 stainless steel with a brushed finish. The spout design features an anti-microbial outlet and in-built intelligent thermistor which connects to our INFORM water temperature monitoring device or CMVL8 hygiene flushing unit. Remotely monitor temperatures, control the outlet, thermal purges and fail safe checks all verified. 5 litres per minute integrated flow control. (other flow rates available).

**IC02-048** INFORM Outlet 190mm - copper tails

**IC02-049** INFORM Outlet 240mm - copper tails

**IC03-052** INFORM Outlet A45 - for wall mounted sensor

**Mandatory accessories:**

**IC07-006** INFORM 6 channel control box

**IC07-017** INFORM programmable sensor

**AC17-047** TMV3 (Not required with IC07-008)

**Complimentary accessories:**

**IC07-008** CMVL8 Control, monitor & verify

**SW00-042** Wall hung clinical basin 500mm

**SW00-045** Wall hung clinical basin 500mm Right hand tap hole

**SW00-043** Hangers & waste adaptor

**SW00-044** 1 1/4" Plastic bottle trap

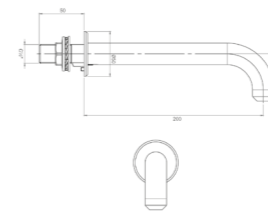

### MEDI-10 90° AUTOCLAVABLE SPOUT

Medi-10 Healthcare Spout™ manufactured in 316 stainless steel with a brushed finish. Designed for healthcare environments with a twist and lock wall mounted spigot mechanism, the spout can easily be removed for servicing for minimal disruption. The spout has been designed to promote and maintain high levels of hygiene with an unrestricted outlet, smooth flow channels and easy to clean shape. The Medi-10 spout can also be autoclaved. Spout projection: 200mm

**AT07-101** Medi-10 90° spout - Stainless steel

**Mandatory accessories:**

**AC02-017** Programmable sensor

**AT00-221** Single antimicrobial station kit

**AC17-047** TMV3

**Complimentary accessories:**

**SW00-042** Wall hung clinical basin 500mm

**SW00-043** Hangers & waste adaptor

**SW00-044** 1 1/4" Plastic bottle trap

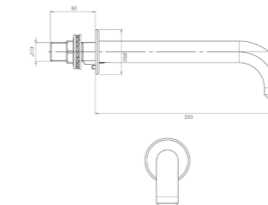

### MEDI-10 90° SPOUT FOR POINT OF USE FILTER

Medi-10 Healthcare Spout™ manufactured in 316 stainless steel with a brushed finish. Designed for healthcare environments with a twist and lock wall mounted spigot mechanism, the spout can easily be removed for servicing for minimal disruption. The spout has been designed to promote and maintain high levels of hygiene with an optional adaptor for point of use filters, smooth flow channels and easy to clean shape. The Medi-10 spout can also be autoclaved. Spout projection: 200mm

**AT07-117** Medi-10 90° spout - Stainless steel

**Mandatory accessories:**

**AT00-044** Adaptor for filters - Medi-10

**AC02-017** Programmable sensor

**AT00-221** Single antimicrobial station kit

**AC17-047** TMV3

**Complimentary accessories:**

**SW00-042** Wall hung clinical basin 500mm

**SW00-043** Hangers & waste adaptor

**SW00-044** 1 1/4" Plastic bottle trap



## INFORM OUTLET

Inform outlet provides a unique range of products that allow you remote, wireless control of solenoid valves & the ability to monitor both usage and temperatures. Inform provides full verification of data and events to ensure water safety and aid compliance.

With an easy to use online platform, detailed reports and an unrivalled range of Inform enabled taps, spouts, showers and clinical basins.

All from a UK business with more than 35 years experience in water management, water hygiene and temperature monitoring.

Full survey and installation service available by qualified KWC DVS Engineers.

# INFORM Outlet

NEW  
INFORM  
ENABLED

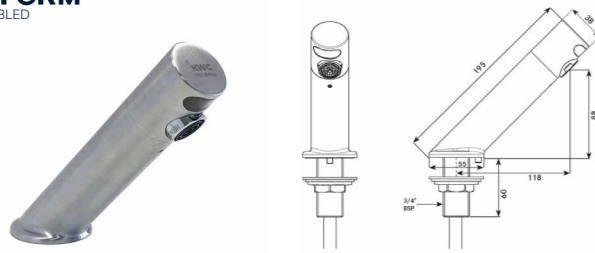

NEW FOR 2024

## INFORM OUTLET A45 - INTEGRATED SENSOR

INFORM Outlet manufactured in 316 stainless steel with a brushed finish. The spout design features an anti-microbial outlet and in-built intelligent thermistor which connects to our INFORM water temperature monitoring device. Remotely monitor temperatures, control the outlet, thermal purges and fail safe checks all verified. 5 litres per minute integrated flow control. (other flow rates available). Outlet projection: 118mm.

IC03-012 INFORM Outlet - Integrated sensor

**Mandatory accessories:**

IC10-066 INFORM Monitor Universal kit

AC17-047 TMV3

**Complimentary accessories:**

SW00-045 Wall hung clinical basin 500mm RH tap hole

SW00-043 Hangers & waste adaptor

SW00-044 1 1/4" Plastic bottle trap

NEW  
INFORM  
ENABLED



NEW FOR 2024

## INFORM OUTLET A45 - WALL MOUNTED SENSOR

INFORM Outlet manufactured in 316 stainless steel with a brushed finish. The spout design features an anti-microbial outlet and in-built intelligent thermistor which connects to our INFORM water temperature monitoring device. Remotely monitor temperatures, control the outlet, thermal purges and fail safe checks all verified. 5 litres per minute integrated flow control. (other flow rates available). Outlet projection: 118mm.

IC03-052 INFORM Outlet A45 - wall mounted sensor

**Mandatory accessories:**

IC07-006 INFORM 6 channel control box

IC07-017 INFORM programmable sensor

AC17-047 TMV3 (Not required with IC07-008)

**Complimentary accessories:**

IC07-008 CMVL8 Control, monitor & verify

SW00-045 Wall hung clinical basin 500mm Right hand tap hole

SW00-043 Hangers & waste adaptor

SW00-044 1 1/4" Plastic bottle trap

NEW  
INFORM  
ENABLED

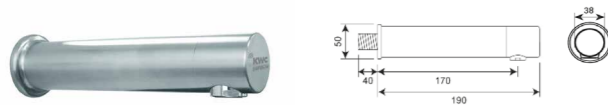

NEW FOR 2024

## INFORM OUTLET 190MM

INFORM clinical outlet manufactured in 316 stainless steel with a brushed finish. The spout design features an anti-microbial outlet and in-built intelligent thermistor which connects to our INFORM water temperature monitoring device or CMVL8 hygiene flushing unit. Remotely monitor temperatures, control the outlet, thermal purges and fail safe checks all verified. 5 litres per minute integrated flow control. (other flow rates available). Outlet projection: 170mm.

IC02-048 INFORM Outlet 190mm

**Mandatory accessories:**

IC07-006 INFORM 6 channel control box

IC07-017 INFORM programmable sensor

AC17-047 TMV3 (Not required with IC07-008)

**Complimentary accessories:**

IC07-008 CMVL8 Control, monitor & verify

SW00-042 Wall hung clinical basin 500mm

SW00-043 Hangers & waste adaptor

SW00-044 1 1/4" Plastic bottle trap

NEW  
INFORM  
ENABLED

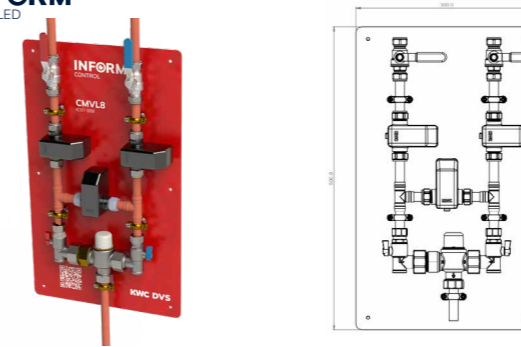

NEW FOR 2024

## CMVL8 CONTROL, MONITOR & VERIFY

The CMVL8 is designed to work in conjunction with the Inform enabled Multi Channel control boxes. Complete with full bore 15mm compression isolation valves, check valves, anti-microbial solenoid valves, temperature sensors and a separate thermostatic mixing valve ready for easy installation.

CMVL8 allows you to carry out Thermal purges through both the outlet & TMV and cold water isolation tests without the need to remove IPS panels or manually operate valves. CMVL8 will also provide detailed, reports with date & time, temperatures etc. to ensure you have the information you need to effectively manage the safety of your water system.

In addition INFORM can provide verification that hot taps are  $\geq 50^{\circ}\text{C}$  ( $55^{\circ}\text{C}$  in healthcare premises) and cold taps are below  $20^{\circ}\text{C}$  within the times required by HSG274 Part 2.

IC07-008 CMVL8 Control, monitor & verify

**Mandatory accessories:**

IC07-006 INFORM 6 channel control box

IC07-017 INFORM programmable sensor

NEW  
INFORM  
ENABLED

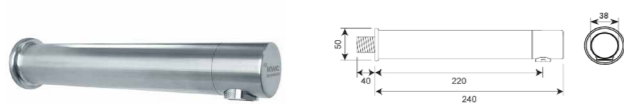

NEW FOR 2024

## INFORM OUTLET 240MM

INFORM clinical outlet manufactured in 316 stainless steel with a brushed finish. The spout design features an anti-microbial outlet and in-built intelligent thermistor which connects to our INFORM water temperature monitoring device or CMVL8 hygiene flushing unit. Remotely monitor temperatures, control the outlet, thermal purges and fail safe checks all verified. 5 litres per minute integrated flow control. (other flow rates available). Outlet projection: 220mm.

IC02-049 INFORM Outlet 240mm

**Mandatory accessories:**

IC07-006 INFORM 6 channel control box

IC07-017 INFORM programmable sensor

AC17-047 TMV3 (Not required with IC07-008)

**Complimentary accessories:**

IC07-008 CMVL8 Control, monitor & verify

SW00-042 Wall hung clinical basin 500mm

SW00-043 Hangers & waste adaptor

SW00-044 1 1/4" Plastic bottle trap

NEW  
INFORM  
ENABLED

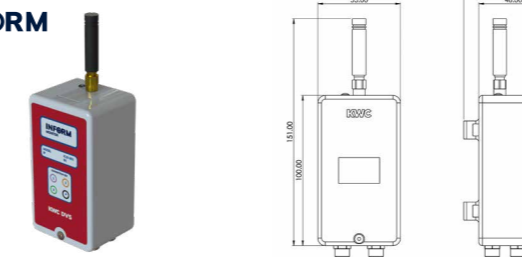

NEW FOR 2024

## INFORM MONITOR UNIVERSAL KIT

INFORM Monitor tracks water system temperatures, from anywhere in the world. Analyse trends and pinpoint areas for improvement. Make data-driven decisions to optimise efficiency and prioritise upgrades.

Universal kit suitable for any part of your water system. Kit includes all parts required to monitor temperatures.

IC10-066 INFORM Monitor Universal kit

KWC DVS washrooms

# Configure your ultimate clinical wash station with INFORM

Choose from INFORM Outlet, INFORM Control and our HBN compliant clinical wash basin for the complete solution.



INFORM Outlet  
IC03-052 A45  
IC07-017 Sensor



INFORM Control  
IC07-008 CMVL8  
IC07-006 6CH Controller  
AC01-001 Programmer



Clinical wash basin RHT  
SW00-045 Basin RHT  
SW00-044 Bottle trap  
SW00-043 Hangers



INFORM Outlet  
IC02-048 190mm  
IC07-017 Sensor



INFORM Control  
IC07-008 CMVL8  
IC07-006 6CH Controller  
AC01-001 Programmer



Clinical wash basin  
SW00-042 Basin  
SW00-044 Bottle trap  
SW00-043 Hangers



INFORM Outlet  
IC02-049 240mm  
IC07-017 Sensor



INFORM Control  
IC07-008 CMVL8  
IC07-006 6CH Controller  
AC01-001 Programmer



Clinical wash basin  
SW00-042 Basin  
SW00-044 Bottle trap  
SW00-043 Hangers

## Control, Monitor & Verify – CMVL8-01

Wirelessly Control thermal purges & TMV cold water isolation tests. Remotely monitor time taken for hot and cold water outlets to achieve temperatures. Verify all relevant data with granular reports. Control, Monitor & Verify your water system is safe and compliant.

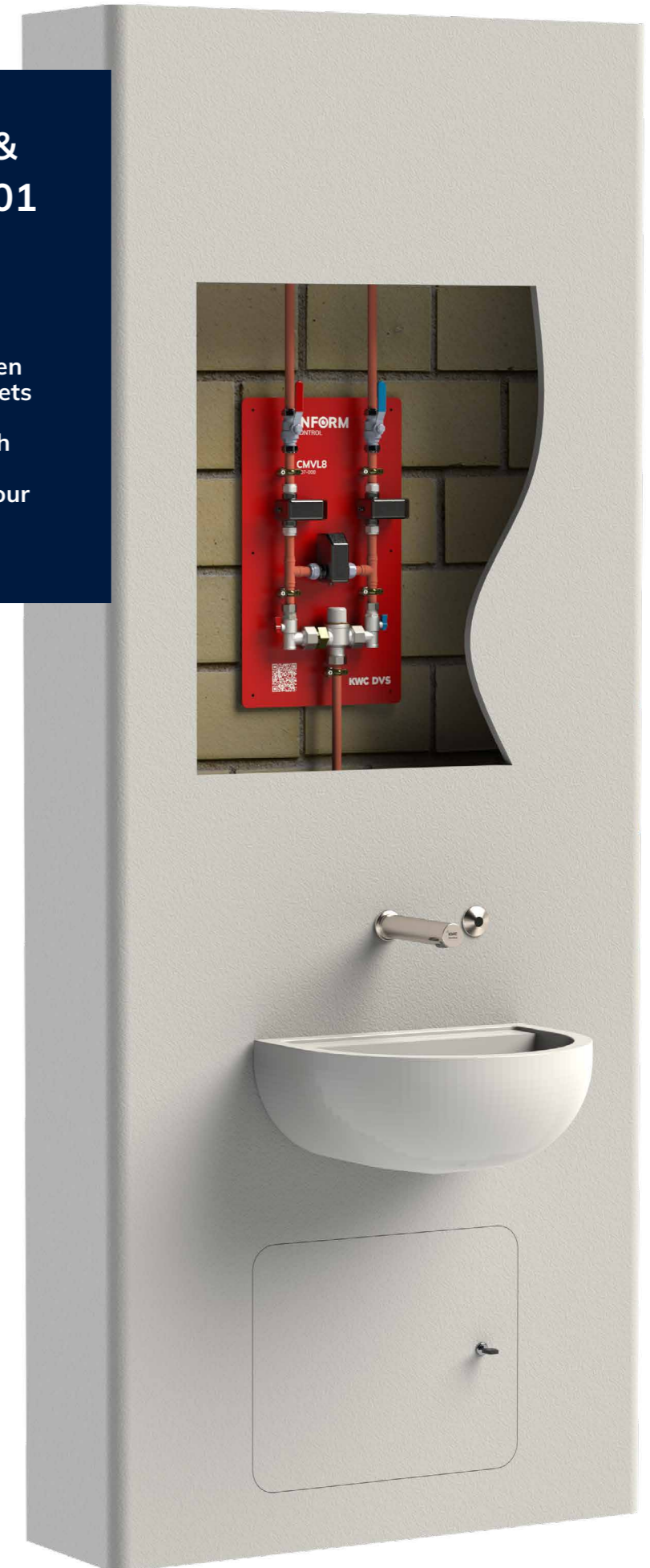



## Scrub up troughs

Infection control is non-negotiable in healthcare settings and surgeon scrub-up troughs play a pivotal role in maintaining a sterile environment. Stainless steel's non-porous surface prevents the accumulation of contaminants, and the ergonomic design ensures efficient water drainage, reducing the risk of stagnant water and potential bacterial growth. The result is a tool that safeguards patients and medical staff alike.



# Surgeon scrub up troughs

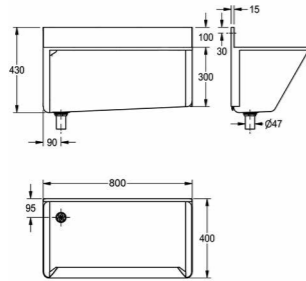

## SISSONS 800MM SUH SURGEONS SCRUB UP TROUGH - LEFT HAND

Manufactured from 1.5mm thick grade 1.4301 (304) stainless steel, with a satin finish. The surgeon scrub up trough is supplied with a conventional waste outlet in the base of the trough and shroud to cover pipework. The top and bottom areas of the trough are fixed to the wall using the joggle strips supplied. Please note - wall fixing screws and plugs are not supplied. Manufactured in accordance with HTM 64 / HBN 00-10, Part C Standards.

Mounting: Surface mounted  
 Outlet: Left hand outlet  
 Dimensions: 800 x 400mm

**G22029LN** 800mm Scrub up trough LH

**Mandatory accessory:**  
**F2068** 38mm flush grated waste

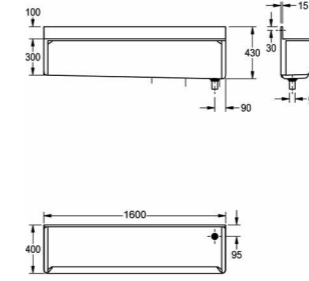

## SISSONS 1600MM SUH SURGEONS SCRUB UP TROUGH - RIGHT HAND

Manufactured from 1.5mm thick grade 1.4301 (304) stainless steel, with a satin finish. The surgeon scrub up trough is supplied with a conventional waste outlet in the base of the trough and shroud to cover pipework. The top and bottom areas of the trough are fixed to the wall using the joggle strips supplied. Please note - wall fixing screws and plugs are not supplied. Manufactured in accordance with HTM 64 / HBN 00-10, Part C Standards.

Mounting: Surface mounted  
 Outlet: Right hand outlet  
 Dimensions: 1600 x 400mm

**G22030RN** 1600mm Scrub up trough RH

**Mandatory accessory:**  
**F2068** 38mm flush grated waste

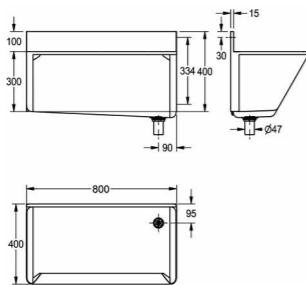

## SISSONS 800MM SUH SURGEONS SCRUB UP TROUGH - RIGHT HAND

Manufactured from 1.5mm thick grade 1.4301 (304) stainless steel, with a satin finish. The surgeon scrub up trough is supplied with a conventional waste outlet in the base of the trough and shroud to cover pipework. The top and bottom areas of the trough are fixed to the wall using the joggle strips supplied. Please note - wall fixing screws and plugs are not supplied. Manufactured in accordance with HTM 64 / HBN 00-10, Part C Standards.

Mounting: Surface mounted  
 Outlet: Right hand outlet  
 Dimensions: 800 x 400mm

**G22029RN** 800mm Scrub up trough RH

**Mandatory accessory:**  
**F2068** 38mm flush grated waste

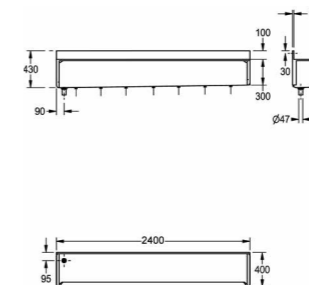

## SISSONS 2400MM SUH SURGEONS SCRUB UP TROUGH - LEFT HAND

Manufactured from 1.5mm thick grade 1.4301 (304) stainless steel, with a satin finish. The surgeon scrub up trough is supplied with a conventional waste outlet in the base of the trough and shroud to cover pipework. The top and bottom areas of the trough are fixed to the wall using the joggle strips supplied. Please note - wall fixing screws and plugs are not supplied. Manufactured in accordance with HTM 64 / HBN 00-10, Part C Standards.

Mounting: Surface mounted  
 Outlet: Left hand outlet  
 Dimensions: 2400 x 400mm

**G22031LN** 2400mm Scrub up trough LH

**Mandatory accessory:**  
**F2068** 38mm flush grated waste

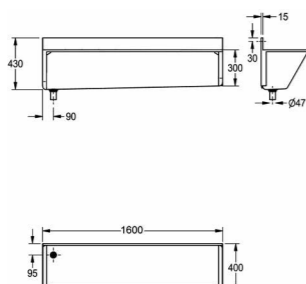

## SISSONS 1600MM SUH SURGEONS SCRUB UP TROUGH - LEFT HAND

Manufactured from 1.5mm thick grade 1.4301 (304) stainless steel, with a satin finish. The surgeon scrub up trough is supplied with a conventional waste outlet in the base of the trough and shroud to cover pipework. The top and bottom areas of the trough are fixed to the wall using the joggle strips supplied. Please note - wall fixing screws and plugs are not supplied. Manufactured in accordance with HTM 64 / HBN 00-10, Part C Standards.

Mounting: Surface mounted  
 Outlet: Left hand outlet  
 Dimensions: 1600 x 400mm

**G22030LN** 1600mm Scrub up trough LH

**Mandatory accessory:**  
**F2068** 38mm flush grated waste

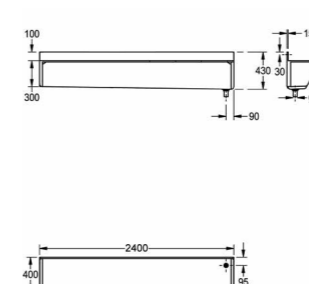

## SISSONS 2400MM SUH SURGEONS SCRUB UP TROUGH - RIGHT HAND

Manufactured from 1.5mm thick grade 1.4301 (304) stainless steel, with a satin finish. The surgeon scrub up trough is supplied with a conventional waste outlet in the base of the trough and shroud to cover pipework. The top and bottom areas of the trough are fixed to the wall using the joggle strips supplied. Please note - wall fixing screws and plugs are not supplied. Manufactured in accordance with HTM 64 / HBN 00-10, Part C Standards.

Mounting: surface mounted  
 Outlet: Right hand outlet  
 Dimensions: 2400 x 400mm

**G22031RN** 2400mm Scrub up trough RH

**Mandatory accessory:**  
**F2068** 38mm flush grated waste



## Medical and utility sinks

Medical and utility sinks have a crucial function within public and semi-public settings. They are essential across a spectrum of spaces, spanning from minor healthcare facilities to large hospitals. This comprehensive collection caters to all needs, whether it be for a new build or a renovation, all the while aligning with HBN and HTM regulations.

Our range of medical and utility sinks encompasses janitorial units, bucket sinks, DUHS sinks, clinical hand wash basins, utility sinks and more. These offerings are designed to fulfill every requirement for your upcoming project. Crafted from premium stainless steel, these products assure longevity throughout the buildings lifespan.

# Cleaning and janitorial

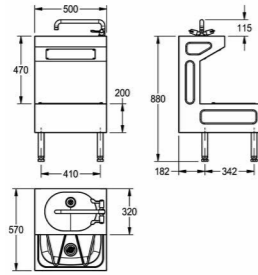

### SISSONS HEALTHCARE COMPLIANT JANITORIAL UNIT

Manufactured from 1.2mm thick, grade 1.4301 (304) stainless steel (except for lower bowl - 0.9mm). Supplied complete with lever operated monobloc mixer, With copper tailss, 32mm flush grated waste outlet for top wash bowl and 38mm domed waste (for lower bowl). The janitorial unit can be fixed with 4 legs for floor standing or part wall hung / floor standing by using two of the front legs or alternatively can be fitted as a wall hung unit by using the joggle strip provided. Manufactured in accordance with HTM 64 / HBN 00-10, Part C Standards.

Tap: Monobloc mixer  
Without overflow  
Dimensions: 500 x 995 x 570mm

- G20055N** Janitorial unit  
**Complimentary accessories:**  
**G20051N** Combination waste kit

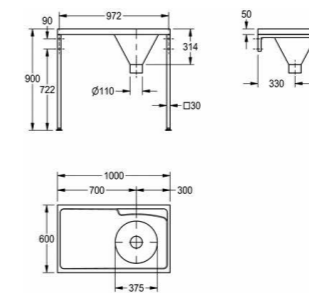

### SISSONS DUH HOSPITAL DISPOSAL UNIT

DUH hospital disposal unit manufactured from 1.2mm thick, grade 304 stainless steel with a satin polish finish. Includes a 110mm diameter outlet sluice hopper which can accept a P or S trap (available as an extra). The unit should only be fed from a cistern or tank water supply. Mounted on either stainless steel cantilever brackets or front leg supports with adjustable feet, which give a working height of 900mm. Manufactured in accordance with HTM 64 / HBN 00-10, Part C Standards.  
Dimensions: 1,000 x 600 x 900mm

- G22016L** Left hand drainer for duct mounted cistern  
**G22016R** Right hand drainer for duct mounted cistern  
**G22025L** Left hand drainer for exposed cistern  
**G22025R** Right hand drainer for exposed cistern

**Mandatory and complimentary accessories listed below**

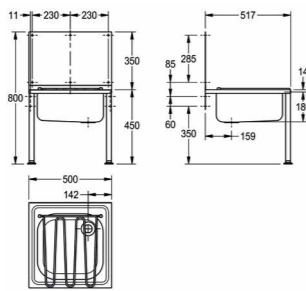

### SISSONS STAINLESS STEEL FLOOR STANDING BUCKET SINK

Manufactured from 1.2mm thick, grade 1.4301 (304) stainless steel. Designed with splash back, hinged grating, 38mm BSP waste fitting and complete with integral wall brackets. The bucket sink is supported on two front legs and is held in position by screwing the two integral wall brackets directly to the wall. Screws and wall plugs are not supplied. Stainless steel bucket is not included.

Dimensions: 500 x 800 x 517mm

- G21663N** Bucket sink  
**Complimentary accessories:**  
**F1071/3N** Pair of bib taps

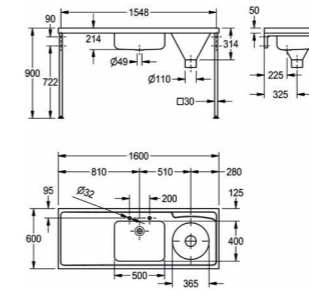

### SISSONS DUHS HOSPITAL DISPOSAL UNIT

A DUHS hospital disposal unit manufactured from stainless steel with a satin polish finish. The top is turned down on all four edges and incorporates a wet area recess. Fitted with a 110mm diameter outlet sluice hopper at one end which can accept a P or S trap, (available as an extra). The unit should only be fed from a cistern or tank water supply. Mounted on either stainless steel cantilever brackets or front leg supports with adjustable feet, which give a working height of 900mm. Manufactured in accordance with HTM 64 / HBN 00-10, Part C Standards.

Without tap holes or overflow  
Dimensions: 1600 x 900 x 600mm

- G22018L** Left hand drainer for duct mount cistern  
**G22018R** Right hand drainer for duct mount cistern  
**G22027L** Left hand drainer for exposed cistern  
**G22027R** Right hand drainer for exposed cistern

**Mandatory and complimentary accessories listed below**

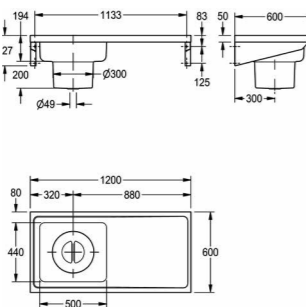

### SISSONS PLASTER SINK

Manufactured from 1.2mm thick grade 1.4301 (304) stainless steel, with a satin finish (bowl - 1.5mm). The single bowl incorporates a plaster catcher sump which is prepared for a 38mm waste (waste sold seperately). An integral sump with a removable stainless steel basket prevents loose plaster from entering the waste and causing a blockage. Designed without tap holes, therefore taps should be wall mounted. Stainless steel cantilever brackets and stainless steel front leg supports can be supplied as an extra, no wall fixing are supplied. Manufactured in accordance with HTM 64 / HBN 00-10, Part C Standards.

Bowl dimensions: 500 x 400 x 200/400mm  
Dimensions: 1200 x 600mm

- G22000LN** Left hand drainer  
**G22000RN** Right hand drainer  
**Mandatory accessories:**  
**F2068** Flush grated waste 1 1/2"  
**G26523L/R** Stainless steel cantilever bracket left/right  
**OR**  
**G26524L/R** Stainless steel front leg support left/right

### SISSONS DUH & DUHS ACCESSORIES FOR DUCT MOUNT

- Mandatory accessories:**  
**G26523L** Stainless steel cantilever bracket left  
**G26523R** Stainless steel cantilever bracket right  
**OR**  
**G26524L** Stainless steel front leg support left  
**G26524R** Stainless steel front leg support right
- B4042** P-trap plastic waste  
**F3018** 9 litre plastic cistern  
**B3022** Plastic down pipe  
**F2055** Cistern pull chain & lever

- For DUHS only optional:**  
**F2068** Flush grated waste 1 1/2"  
**G26542N** Grating for DUHS

### SISSONS DUH & DUHS ACCESSORIES FOR SURFACE MOUNT

- Mandatory accessories:**  
**G26523L** Stainless steel cantilever bracket left  
**G26523R** Stainless steel cantilever bracket right  
**OR**  
**G26524L** Stainless steel front leg support left  
**G26524R** Stainless steel front leg support right
- B4052** P-trap stainless steel waste  
**G20605N** 9 litre stainless steel cistern  
**B4215** Stainless steel down pipe  
**F2055** Cistern pull chain & lever

- For DUHS only optional:**  
**F2068** Flush grated waste 1 1/2"  
**G26542N** Grating for DUHS

# Cleaning and janitorial

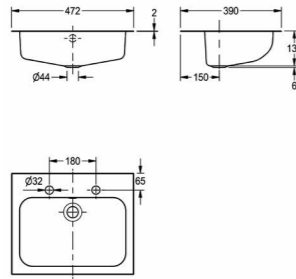

### SISSONS INSET WASH BASIN WITH TAP LANDING

Manufactured from 0.9mm thick grade 1.4301 (304) stainless steel. Prepared with 32mm waste outlet and overflow hole, and a rear ledge with two tap holes suitable for either basin taps of mixer taps. Supplied with fixing clips for inseting into worktops. Waste kit is available as an extra.

Finish: Descaled  
 Tap holes: 2  
 With overflow  
 Waste: Centre  
 Bowl dimensions: 410 x 265 x 140mm  
 Dimensions: 472 x 390 x 140mm

- D20168N** Inset washbasin  
**Mandatory accessories:**  
**F2117** 32mm waste, plug, chain and overflow  
**Complimentary accessories:**  
**F1074N** 3mm high neck lever taps

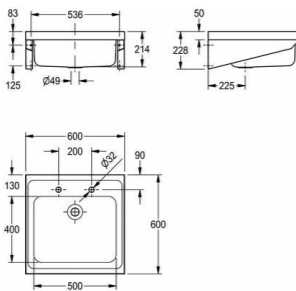

### SISSONS SK1 WALL MOUNTED SINGLE BOWL SINK

Manufactured from 1.2mm thick, grade 1.4301 (304) stainless steel with satin polish finish. The sink top is turned down on all four edges and incorporates a wet area recess. The bowl is prepared for a 38mm waste outlet and the sink top can either be mounted on wall brackets or front leg supports (sold separately). NOTE: It is not possible to fit an overflow. Manufactured in accordance with HTM 64 / HBN 00-10, Part C Standards.

Without overflow  
 Bowl dimensions: 500 x 400 x 200mm  
 Dimensions: 600 x 600 x 218mm

- G22002N** Without tap holes  
**G22002NT** Tap holes: 2 at 200mm centres  
**Mandatory accessories:**  
**F2068** 38mm flush grated waste  
**G26523L/R** Stainless steel cantilever bracket left/right  
**OR**  
**G26524L/R** Stainless steel front leg support left/right  
**Complimentary accessories:**  
**F1074N** 3mm high neck lever taps

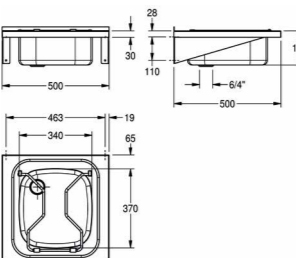

### SISSONS CLEANERS SINK WITH GRID FOR WALL MOUNTING

Manufactured from 1.5mm thick, grade 1.4301 (304) stainless steel with satin finish. Designed with a seamlessly welded bowl with rounded edges. Incorporates 38mm plug waste with a plastic overflow pipe, drainage back left, 30mm rear up-stand. Supplied with stainless steel grid with rubber bumps, stainless steel screws and dowels.

Mounting: Wall mounted  
 Bowl dimensions: 370 x 160 x 340mm  
 Dimensions: 500 x 160 x 500mm

- WB500GV** Cleaners sink with grid for wall mounting

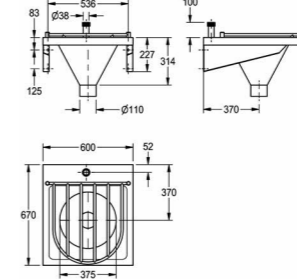

### SISSONS WALL MOUNTED DOMESTIC SERVICES DISPOSAL UNIT

Manufactured from 1.2mm thick, grade 1.4301 (304) stainless steel with satin finish. Incorporates a sluce hopper with a back inlet suitable for wall mounting. The hopper is designed with a 110mm diameter outlet which can accept a P trap (sold separately). The unit should only be fed from a cistern or tank water supply. 6, 7 or 9 litre steel cisterns are available as extras. These are fitted with a 13mm HP brass valve, plastic float and CP metal flushing lever handles. The unit is fixed to the wall using two cantilever brackets and wall fixings (sold separately).

Suitable for surface mounted cisterns  
 Sluce dimensions: 375/110 x 300mm  
 Dimensions: 670 x 300 x 600mm

- G22043N** Cleaners sink  
**Mandatory accessories:**  
**B4052** 110mm stainless steel adjustable P trap  
**G26542N** Stainless steel removable outlet grating 110mm  
**G20605N** 9 litre stainless steel cistern  
**B4215** Stainless steel downpipe  
**G26523L/R** Stainless steel cantilever bracket left/right  
**OR**  
**G26524L/R** Stainless steel front leg support left/right

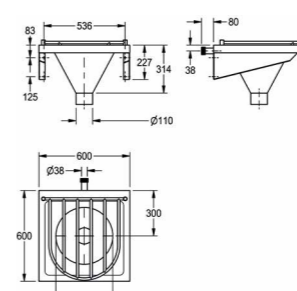

### SISSONS WALL MOUNTED DOMESTIC SERVICES DISPOSAL UNIT

Manufactured from 1.2mm thick, grade 1.4301 (304) stainless steel with satin finish. Incorporates a sluce hopper with a back inlet suitable for duct mounting. The hopper is designed with a 110mm diameter outlet which can accept a P trap (sold separately). The unit should only be fed from a cistern or tank water supply. A duct mounted 9 litre plastic cistern is available separately, this is supplied with a plastic downpipe, plastic float and metal flushing lever handles. The unit is fixed to the wall using two cantilever brackets and wall fixings (sold separately). Manufactured in accordance with HTM 64 / HBN 00-10, Part C Standards.

Suitable for duct mounted cisterns  
 Dimensions: 600 x 300 x 600mm

- G22041N** Bucket sink  
**Mandatory accessories:**  
**B4042** White plastic P trap for hospital units  
**G26542N** Stainless steel removable outlet grating 110mm  
**F3018** 9 litre plastic cistern  
**B3022** Plastic downpipe  
**G26523L/R** Stainless steel cantilever bracket left/right  
**OR**  
**G26524L/R** Stainless steel front leg support left/right

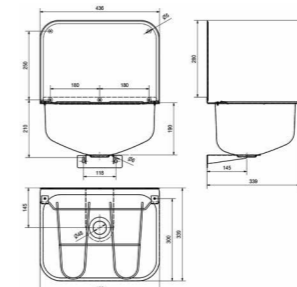

### SISSONS WALL MOUNTED CLEANERS SINK WITH GRID

Manufactured from grade 1.4301 (304) stainless steel, material thickness 0.9mm, with splash back, hinged grating, 38mm BSP waste fitting and complete with integral wall bracket.

Cleaners sink  
 Mounting: Wall mounted  
 Bowl dimensions: 436 x 190 x 300mm  
 Dimensions: 436 x 490 x 339mm

- WB440COP-UK** Cleaners sink

# Cleaning and janitorial

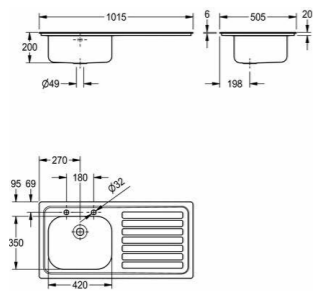

## SISSONS STAINLESS STEEL SINGLE BOWL, SINGLE DRAINER INSET SINK WITH OVERFLOW

Manufactured from 0.9mm thick, grade 1.4301 (304) stainless steel with satin finish. This sink has all four sides incorporating a rimmed edge profile, suitable for inseting into a standard sized worktop. The bowl is prepared for a 38mm waste. Supplied complete with fixing clips.

Tap holes: 2 at 180mm centres  
With overflow  
Bowl dimensions: 420 x 350 x 180mm  
Dimensions: 1015 x 505 x 200mm

- B20085L** Left hand drainer
- Mandatory accessories:**
- F2119** 38mm waste, plug, chain and overflow
- Complimentary accessories:**
- F1081N** 13mm crosshead pillar taps  
**F1083N** 13mm fluted handle pillar taps  
**F1026N** 13mm deck pattern mixer tap

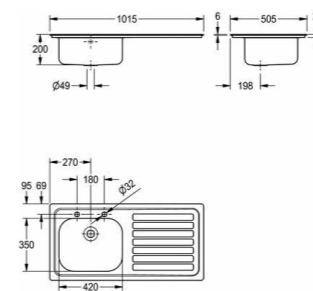

## SISSONS STAINLESS STEEL SINGLE BOWL, SINGLE DRAINER INSET SINK WITH OVERFLOW

Manufactured from 0.9mm thick, grade 1.4301 (304) stainless steel with satin finish. This sink has all four sides incorporating a rimmed edge profile, suitable for inseting into a standard sized worktop. The bowl is prepared for a 38mm waste. Supplied complete with fixing clips.

Tap holes: 2 at 180mm centres  
With overflow  
Bowl dimensions: 420 x 350 x 180mm  
Dimensions: 1015 x 505 x 200mm

- B20085R** Right hand drainer
- Mandatory accessories:**
- F2119** 38mm waste, plug, chain and overflow
- Complimentary accessories:**
- F1081N** 13mm crosshead pillar taps  
**F1083N** 13mm fluted handle pillar taps  
**F1026N** 13mm deck pattern mixer tap

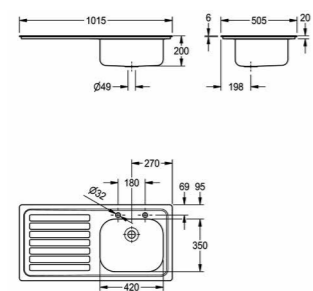

## SISSONS STAINLESS STEEL SINGLE BOWL, SINGLE DRAINER INSET SINK WITHOUT OVERFLOW

Manufactured from 0.9mm thick, grade 1.4301 (304) stainless steel with satin finish. This sink has all four sides incorporating a rimmed edge profile, suitable for inseting into a standard sized worktop. The bowl is prepared for a 38mm waste. Supplied complete with fixing clips.

Tap holes: 2 at 180mm centres  
Without overflow  
Bowl dimensions: 420 x 350 x 180mm  
Dimensions: 1015 x 505 x 200mm

- B20085LT** Left hand drainer
- Mandatory accessories:**
- F2068** 38mm CP brass flush grated waste
- Complimentary accessories:**
- F1081N** 13mm crosshead pillar taps  
**F1083N** 13mm fluted handle pillar taps  
**F1026N** 13mm deck pattern mixer tap

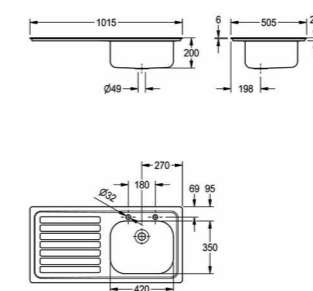

## SISSONS STAINLESS STEEL SINGLE BOWL, SINGLE DRAINER INSET SINK WITHOUT OVERFLOW

Manufactured from 0.9mm thick, grade 1.4301 (304) stainless steel with satin finish. This sink has all four sides incorporating a rimmed edge profile, suitable for inseting into a standard sized worktop. The bowl is prepared for a 38mm waste. Supplied complete with fixing clips.

Tap holes: 2 at 180mm centres  
Without overflow  
Bowl dimensions: 420 x 350 x 180mm  
Dimensions: 1015 x 505 x 200mm

- B20085RT** Right hand drainer
- Mandatory accessories:**
- F2068** 38mm CP brass flush grated waste
- Complimentary accessories:**
- F1081N** 13mm crosshead pillar taps  
**F1083N** 13mm fluted handle pillar taps  
**F1026N** 13mm deck pattern mixer tap

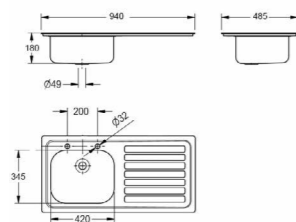

## RODAN SINGLE BOWL, SINGLE DRAINER INSET SINK WITH TAP HOLES

Manufactured from 0.9mm thick, grade 1.4301 (304) stainless steel with satin finish. Supplied with fixing clips, sound deadening pad and earth tag located on the clip rail. Supplied with 38mm waste, without overflow.

Drainer: Left/Right hand drainer available  
Tap holes: 2 at 200mm centres  
Bowl dimensions: 420 x 345 x 180mm  
Dimensions: 940 x 485 x 180mm

- F0359P** Right hand drainer  
**F0360P** Left hand drainer

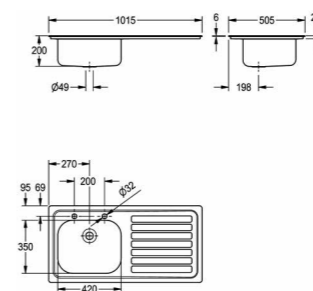

## SISSONS STAINLESS STEEL SINGLE BOWL, SINGLE DRAINER INSET SINK WITH TAP HOLES

Manufactured from 0.9mm thick, grade 1.4301 (304) stainless steel with satin finish. This sink has all four sides incorporating a rimmed edge profile, suitable for inseting into a standard sized worktop. The bowl is prepared for a 38mm waste. Supplied complete with fixing clips.

Drainer: Left hand single drainer  
Tap holes: 2 at 200mm centres  
Without overflow  
Bowl dimensions: 420 x 350 x 180mm  
Dimensions: 1015 x 505 x 200mm

- B20085LT2** Left hand drainer  
**B20085RT2** Right hand drainer
- Mandatory accessories:**
- F2068** 38mm CP brass flush grated waste
- Complimentary accessories:**
- F1074N** 13mm lever taps  
**F1075N** 13mm mixer taps

KWC DVS washrooms

## HBN compliant sinks

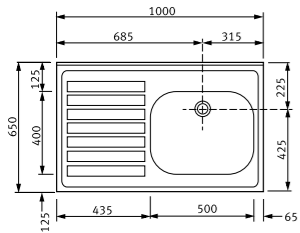

G22048L/R

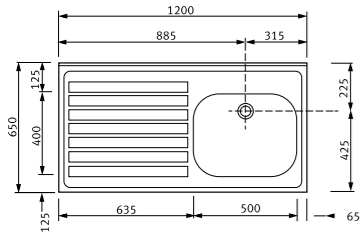

G22049L/R

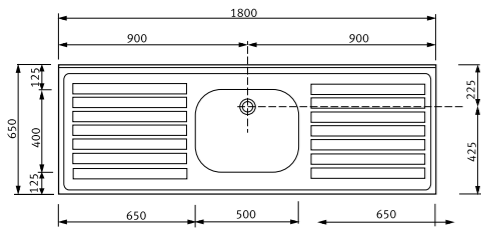

G22052N

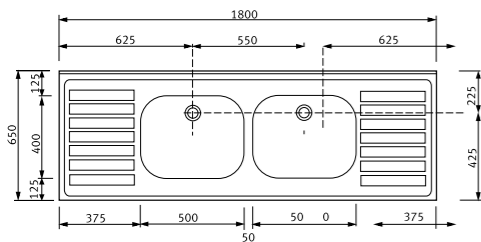

G22053N

### SISSONS SIT ON SINKS WITH RADIUSED FRONT EDGE

A range of sinks manufactured from 1.2mm thick, grade 1.4301 (304) stainless steel, satin polish finish. Each sink profile incorporates a radiused front edge together with a radiused internal corner at the base of the upstand. All sink bowls are prepared for a 38mm waste outlet which can be supplied as an extra.

All the sink units are suitable for mounting onto cabinets, front leg supports or cantilevered brackets - see recommended listed below.

External Dimensions: 1000 x 650 x 220mm

<b>G22048L</b>	Single bowl, left hand drainer, no tap holes
<b>G22048R</b>	Single bowl, right hand drainer, no tap holes
<b>G22048LT</b>	Single bowl, left hand drainer, with 2 tapholes at 200mm centres
<b>G22048RT</b>	Single bowl, right hand drainer, with 2 tapholes at 200mm centres

External Dimensions: 1200 x 650 x 220mm

<b>G22049L</b>	Single bowl, left hand drainer, no tap holes
<b>G22049R</b>	Single bowl, right hand drainer, no tap holes
<b>G22049LT</b>	Single bowl, left hand drainer, with 2 tapholes at 200mm centres
<b>G22049RT</b>	Single bowl, right hand drainer, with 2 tapholes at 200mm centres

External Dimensions: 1800 x 650 x 220mm

<b>G22052N</b>	Single bowl, double drainer, no tapholes
<b>G22053N</b>	Double bowl, double drainer, no tapholes
<b>G22052NT</b>	Single bowl, double drainer, with 2 tapholes at 200mm centres
<b>G22053NT</b>	Double bowl, double drainer, with 2 tapholes at 200mm centres

Mandatory for all

<b>F2068</b>	38mm CP brass flush grated waste outlet
--------------	---

Complimentary front leg supports and brackets

<b>G26523L</b>	Stainless steel cantilever bracket left and
<b>G26523R</b>	Stainless steel cantilever bracket right
<b>G26524L</b>	Stainless steel front leg support left and
<b>G26524R</b>	Stainless steel front leg support right

Complimentary for all units with 2 tapholes

<b>F1074N</b>	13mm high necked lever operated taps
<b>F1075N</b>	13mm mixer lever tap

Complimentary for all units with no tapholes

<b>F4LT1024</b>	F4LT-MED thermostatic single lever mixer
<b>AT02-022</b>	Aquarius 250mm with copper tails

Manufactured in accordance with the Health Building Notes (HBN 00-10, Part C) standards

## INFORM OUTLET

Take control of your water system and accurately monitor the temperature at the outlet 24/7.

Integrate with INFORM Monitor to have the management information you need and ensure you have a safe water system.

With fully configurable alarms, audit trails, detailed reports and much more.

Get in touch for more information and to arrange a **FREE** trial [kwcdvssales@kwc.com](mailto:kwcdvssales@kwc.com)



# HBN compliant sinks

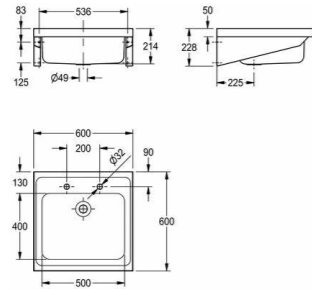

### SISSONS SK1 WALL MOUNTED SINGLE BOWL SINK

Manufactured from 1.2mm thick, grade 1.4301 (304) stainless steel with satin polish finish. The sink top is turned down on all four edges and incorporates a wet area recess. The bowl is prepared for a 38mm waste outlet and the sink top can either be mounted on wall brackets or front leg supports (sold separately). NOTE: It is not possible to fit an overflow. Manufactured in accordance with HTM 64 / HBN 00-10, Part C Standards.

Without overflow  
Bowl dimensions: 500 x 400 x 200mm  
Dimensions: 600 x 600 x 218mm

- G22002N Without tap holes
- G22002NT Tap holes: 2 at 200mm centres
- Mandatory accessories:**
- F2068 38mm flush grated waste
- G26523L/R Stainless steel cantilever bracket left/right
- OR
- G26524L/R Stainless steel front leg support left/right
- Complimentary accessories:**
- F1074N 3mm high neck lever taps

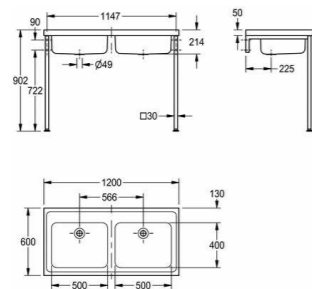

### SISSONS SK2 WALL MOUNTED DOUBLE BOWL SINK

Manufactured from 1.2mm thick, grade 1.4301 (304) stainless steel with satin polish finish. The sink top is turned down on all four edges and incorporates a wet area recess. The bowls are prepared for a 38mm waste outlet and the sink top can either be mounted on wall brackets or front leg supports (sold separately). Manufactured to HTM 64 / HBN 00-10, Part C Standards.

Wall mounted  
Without tap holes and without overflow  
Bowl dimensions: 500 x 400 x 200mm  
Dimensions: 1200 x 600 x 218mm

- G22004N Double bowl sink
- Mandatory accessories:**
- F2068 38mm flush grated waste
- G26523L/R Stainless steel cantilever bracket left/right
- OR
- G26524L/R Stainless steel front leg support left/right

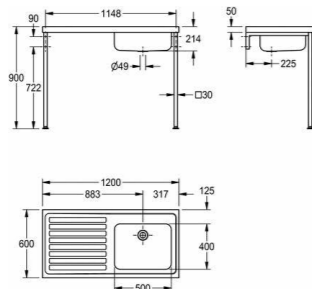

### SISSONS STA SINGLE BOWL, SINGLE DRAINER SIT ON SINK

Manufactured from 1.2mm thick, grade 1.4301 (304) stainless steel with satin polish finish. This sink top is turned down on all four edges and incorporates a wet area recess. The bowl is prepared for a 38mm waste outlet and the sink top can either be mounted on wall brackets or front leg supports (sold separately). Manufactured to HTM 64 / HBN 00-10, Part C Standards.

Without tap holes and without overflow  
Bowl dimensions: 500 x 400 x 200mm  
Dimensions: 1200 x 600 x 218mm

- G22006L With left hand drainer
- G22006R With right hand drainer
- Mandatory accessories:**
- F2068 38mm flush grated waste
- G26523L/R Stainless steel cantilever bracket left/right
- OR
- G26524L/R Stainless steel front leg support left/right

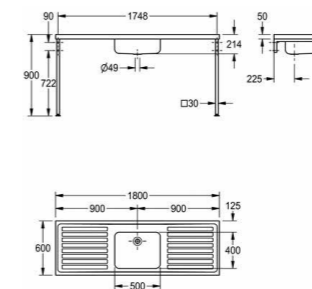

### SISSONS STB SINGLE BOWL, DOUBLE DRAINER SIT ON SINK

Manufactured from 1.2mm thick, grade 1.4301 (304) stainless steel with satin polish finish. The sink top is turned down on all four edges and incorporates a wet area recess. The bowl is prepared for a 38mm waste outlet and the sink top can either be mounted on wall brackets or front leg supports (sold separately). Designed without tap holes, therefore any taps to be fitted must be mounted onto the wall. Manufactured to HTM 64 / HBN 00-10, Part C Standards.

Without tap holes and without overflow  
Bowl dimensions: 500 x 400 x 200mm  
Dimensions: 1800 x 600 x 218mm

- G22008D Single bowl sink
- Mandatory accessories:**
- F2068 38mm flush grated waste
- G26523L/R Stainless steel cantilever bracket left/right
- OR
- G26524L/R Stainless steel front leg support left/right

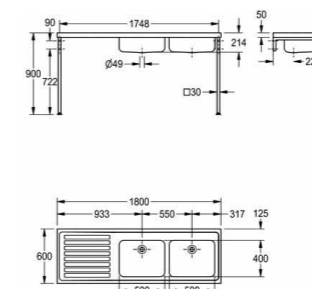

### SISSONS STC DOUBLE BOWL, SINGLE DRAINER SIT ON SINK

Manufactured from 1.2mm thick, grade 1.4301 (304) stainless steel with satin polish finish. The sink top is turned down on all four edges and incorporates a wet area recess. The bowls are prepared for a 38mm waste and requires three brackets or three front leg supports (sold separately). NOTE: It is not possible to fit an overflow. Designed without tap holes, therefore any taps to be fitted must be mounted onto the wall. Manufactured to HTM 64 / HBN 00-10, Part C Standards.

Without tap holes and without overflow  
Bowl dimensions: 500 x 400 x 200mm  
Dimensions: 1800 x 600 x 218mm

- G22010L With left hand drainer
- G22010R With right hand drainer
- Mandatory accessories:**
- F2068 38mm flush grated waste
- G26523L/R Stainless steel cantilever bracket left/right
- OR
- G26524L/R Stainless steel front leg support left/right

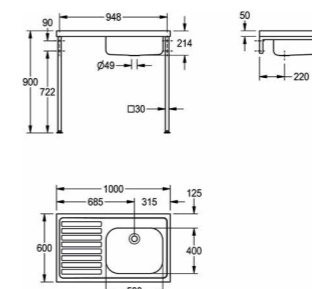

### SISSONS A SINGLE BOWL, SINGLE DRAINER SIT ON SINK

Manufactured from 1.2mm thick, grade 1.4301 (304) stainless steel with satin polish finish. The sink top is turned down on all four edges and incorporates a wet area recess. The bowl is prepared for a 38mm waste outlet and the sink top can either be mounted on wall brackets or front leg supports (sold separately). Manufactured to HTM 64 / HBN 00-10, Part C Standards.

Drainer: Left/Right hand drainer available  
Without tap holes and without overflow  
Bowl dimensions: 400 x 400 x 180mm  
Dimensions: 1000 x 600 x 220mm

- G22045L With left hand drainer
- G22045R With right hand drainer
- Mandatory accessories:**
- F2068 38mm flush grated waste
- G26523L/R Stainless steel cantilever bracket left/right
- OR
- G26524L/R Stainless steel front leg support left/right

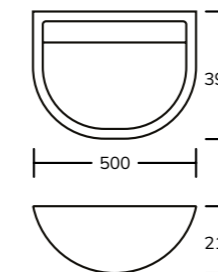

### WALL HUNG CLINICAL BASIN 500 MM

Clinical wall hung basin, manufactured from Vitreous china with an alpine white finish. Designed without tap holes and overflow. Back outlet for increased infection prevention.

HBN & HTM Compliant  
Dimensions: 500 x 215 x 390 mm

- SW00-042 Clinical basin
- Mandatory accessories:**
- SW00-044 1 1/4" Plastic bottle trap
- SW00-043 Hangers and waste adaptor



## Urinals

KWC DVS have designed a wide range of urinal bowls and troughs. Manufactured in quality materials including vitreous china and robust stainless steel to suit any washroom environment.

Adding matching flush controls or intelligent smart urinal sensors you can revolutionise the users washroom experience whilst elevating hygiene with our touch-free programmable flush sensors.

NEW - Discover the F5 Smart Urinal Flushing System that only requires a single central ceiling sensor to control up to 20 urinals. Our advanced technology ensures optimal flushing performance while simplifying your setup.



# Urinals

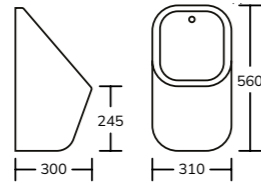

## MARDEN CERAMIC URINAL

Concealed trap single urinal, manufactured from high quality vitreous china to BS 340. For use with a back inlet spreader and concealed cistern feed. HBN / HTM compliant urinal bowl.

Dimensions: 310 x 560 x 300mm

**SW00-036** Ceramic urinal

**Mandatory accessories:**

**SW00-037** Urinal spreader

**SW00-039** Domed urinal waste

**SW00-040** P trap

**SW00-041** Plastic elbow

**Complimentary accessories:**

**SW00-038** Ceramic urinal divider

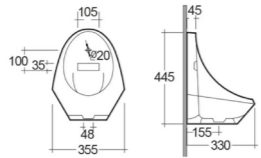

## CHARTHAM EXPOSED TRAP URINAL BOWL

Exposed trap urinal, manufactured from high quality vitreous china to BS 340. Designed to be installed with either a back inlet spreader for concealed cistern feed or top inlet spreader for exposed cistern feed. Sleek easy to clean design with exposed bottle trap, can be mounted at lower height.

Dimensions: 355 x 445 x 330mm

**SW00-080** Exposed urinal

**SW00-081** Hanging brackets

**SW00-082** Plastic resealing bottle trap

**SW00-039** Domed waste

**SW00-083** Top Inlet urinal spreader

OR

**SW00-037** Back inlet urinal spreader

**Complimentary accessories:**

**SW00-038** Ceramic urinal divider

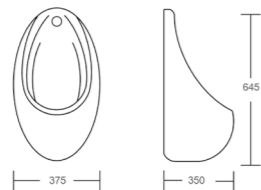

## LANGLEY CONCEALED TRAP URINAL BOWL

Concealed trap urinal bowl, manufactured from high quality vitreous china to BS 340. Sleek easy to clean design with concealed bottle trap.

HBN / HTM compliant urinal bowl

Dimensions: 375 x 645 x 350mm

**SW00-084** Concealed urinal

**SW00-085** Back inlet spreader

**SW00-086** Urinal fixings

**SW00-039** Domed urinal waste

**SW00-040** P trap

**SW00-041** Plastic elbow

**Complimentary accessories:**

**SW00-038** Ceramic urinal divider

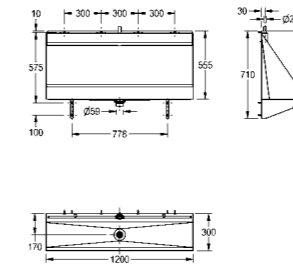

## CENTINEL URINAL TROUGHS - CONCEALED SPARGE

Centinel wall mounted urinals with concealed sparge pipe. Manufactured from 1.2mm thick grade 1.4301 (304) stainless steel with a satin polish finish. Designed with the waste outlet positioned centrally within the urinal. Supplied complete with a 50mm waste, concealed sparge pipes, sparge pipe cover, interconnecting pipework, plastic cistern, downpipe and trap cover. The recommended height for fixing the cisterns is 750 - 950mm, from the underside of the cistern to the top return of the urinal. All urinals are screw fixed to the wall through fixing holes in the top flange together with separate wall mounted brackets which support the base of the unit.

Dimensions: 555 x 300mm

**CEN120C** 1200mm wide urinal

**CEN150C** 1500mm wide urinal

**CEN180C** 1800mm wide urinal

**CEN240C** 2400mm wide urinal

**Complimentary accessories:**

**UC01-017** Flushmatic urinal control wall mounted - mains

OR

**UC01-024** Flushmatic urinal control ceiling mounted - mains

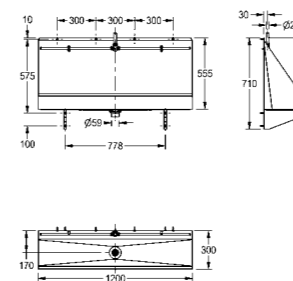

## CENTINEL URINAL TROUGHS - EXPOSED SPARGE

Centinel wall mounted urinals with exposed sparge pipe. Manufactured from 1.2mm thick grade 1.4301 (304) stainless steel with a satin polish finish. Designed with the waste outlet positioned centrally within the urinal. Supplied complete with a 50mm waste, exposed sparge pipes, sparge pipe cover, interconnecting pipework, plastic cistern and downpipe. The recommended height for fixing the cisterns is 750 - 950mm, from the underside of the cistern to the top return of the urinal. All urinals are screw fixed to the wall through fixing holes in the top flange together with separate wall mounted brackets which support the base of the unit.

Dimensions: 555 x 300mm

**CEN120E** 1200mm wide urinal

**CEN150E** 1500mm wide urinal

**CEN180E** 1800mm wide urinal

**CEN240E** 2400mm wide urinal

**Complimentary accessories:**

**UC01-017** Flushmatic urinal control wall mounted - mains

OR

**UC01-024** Flushmatic urinal control ceiling mounted - mains

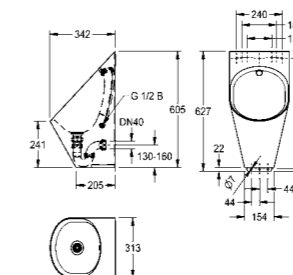

## CAMPUS URINAL POD

CAMPUS wall-mounted urinal made of 304 chromium-nickel steel, satin finished surface, bowl material thickness 1.2mm, shroud 0.9mm, oval bowl shape, stainless steel spreader with G 1/2 connecting hose, punched strainer waste, including DN 40 siphon, mounting strip and mounting material.

Dimensions 313 x 627 x 342mm

**CMPX539** Stainless steel urinal

**Complimentary accessories:**

**CMPX560** Stainless steel Urinal divider

**CMPX136** Urinal installation frame

# Control up to 20 urinals with one F5 smart urinal sensor

## F5 SMART urinal sensors

Public toilet facilities with high footfall pose major challenges for planners and operators in terms of hygiene and cleanliness. Absolute reliability of the products used has the highest priority, especially for urinal systems.

The F5 Smart Urinal Sensor is ideally suited to these requirements and is now not only available for ceramic urinals, but also for single and row urinals made of stainless steel. With the help of central room monitoring, the sensor mounted on the ceiling ensures that urinals are flushed automatically after each use. The sensor registers the users presence in the room solely on the basis of physical parameters, i.e. without a camera function.

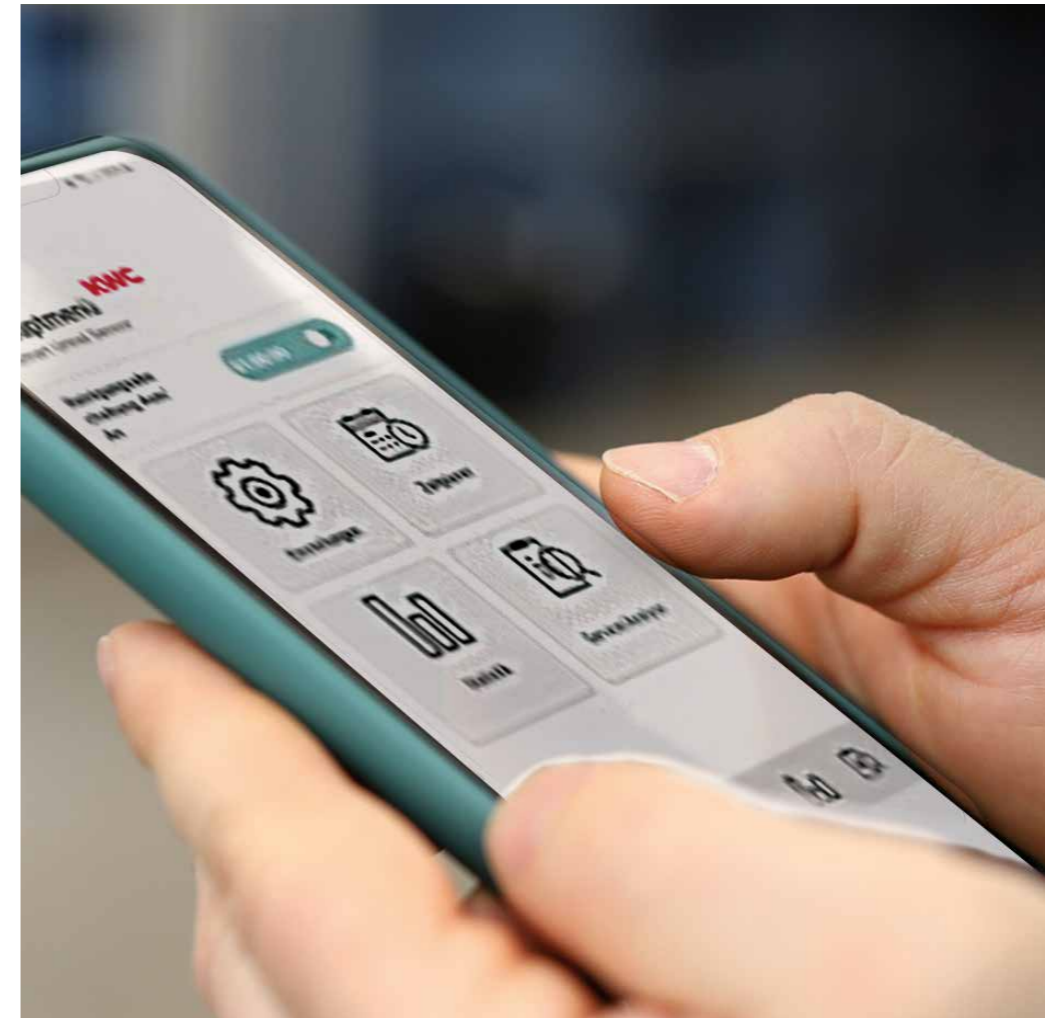
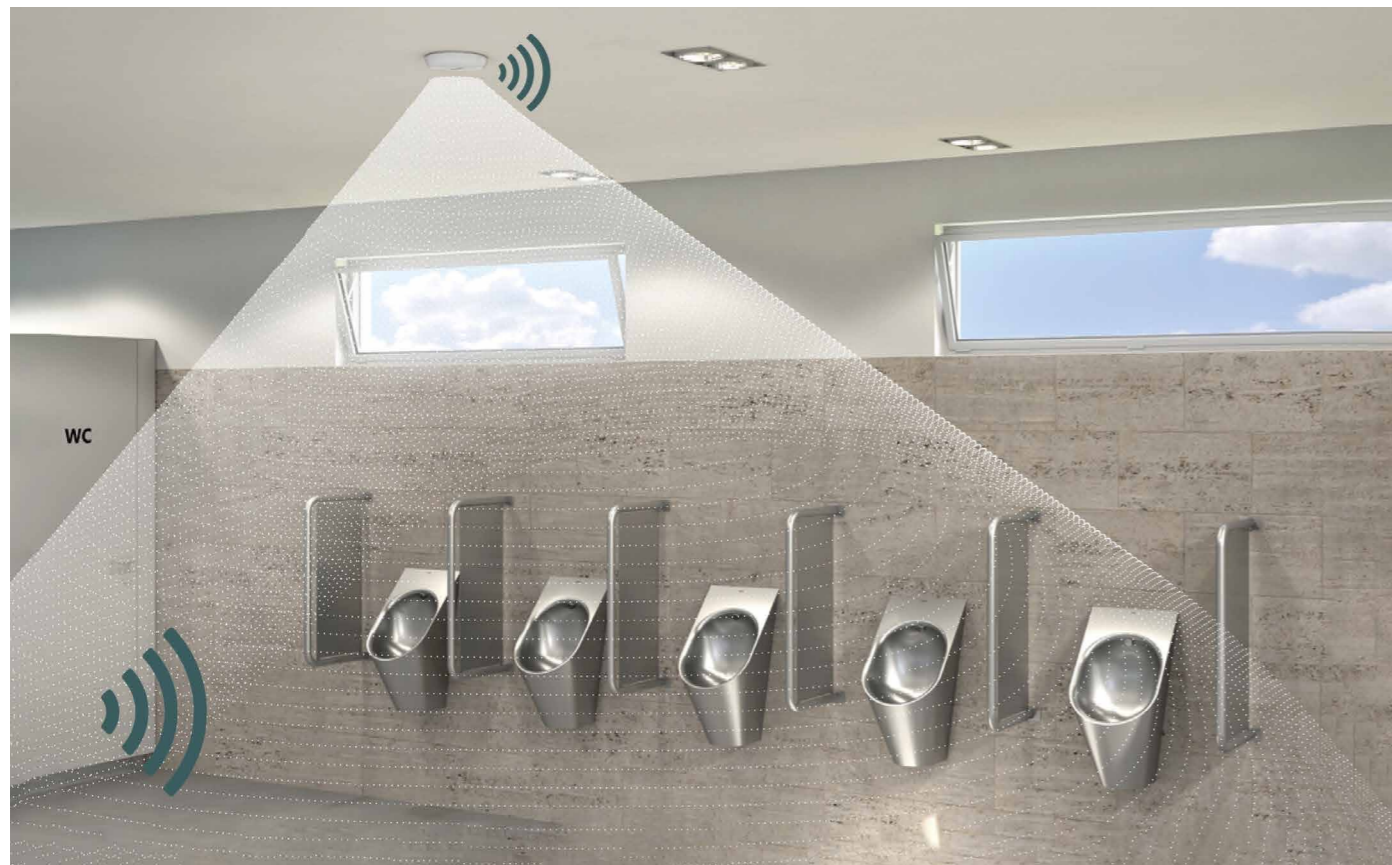

The "Smart Urinal" app is available for commissioning and controlling the Smart Urinal Sensor, it also enables other functions to be programmed.

## Intelligent, central control

With the F5 Smart Urinal Flushing System, you only need a single central ceiling sensor to control up to 20 urinals. Our advanced technology ensures optimal flushing performance whilst simplifying your setup.

The system involves a central room monitoring setup where sensors are mounted on the ceiling. These sensors communicate wirelessly with Smart Urinal Units installed behind the urinals, triggering automatic flushing after each use. The F5 Smart Urinal Sensor is designed for both single and row urinals, and can be installed in urinals made of stainless steel or ceramic materials.



# Intelligent urinal controls

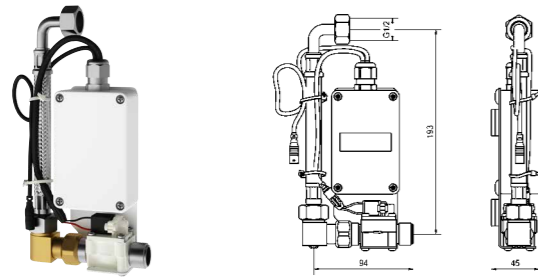

## F5 SMART URINAL UNIT FOR GREY WATER FED SINGLE URINAL - BOWL MOUNTED

F5 smart urinal unit for installation behind a single urinal made of CMPX539 stainless steel. Water path pre-assembled with hose for water connection, locking and solenoid valve. Control unit in sealed plastic box for wireless communication with the F5 smart urinal sensor. Either for battery operation with 6 V lithium battery (CR-P2) per control unit or separate power supply via power supply unit 6.75 V/12 V DC.

Battery compartment including battery or power supply unit with extension cable must be ordered separately.

- ACEF3003** F5 Smart urinal bowl mount - grey water  
**Mandatory accessories:**  
**ACEX9010** Extension cable 5m  
**F5EF3009 (black) OR F5EF3008 (white)** F5 Smart urinal sensor  
**ACEX9023 (battery) OR ACEX9001 (mains)** Power supply

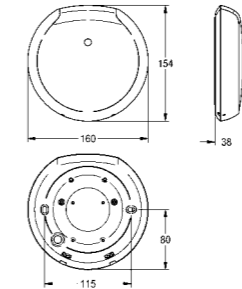

## F5 SMART URINAL SENSOR BLACK

F5 smart urinal sensor for overhead installation for central flushing of urinal systems in a room. Control module in black plastic housing, for multiple simultaneous user detection and touch-free triggering of flushing programmes for connected F5 smart urinal units via wireless communication. Option to connect up to 20 F5 smart urinal units. The area covered by the sensors is dependent on the ceiling height. Activated, washing area-dependent hygiene flushing 24 hours after last activation and saving of statistical data. Commissioning and flushing programme selection and parametrisation for each smart urinal unit via the necessary app, installed on Bluetooth®-enabled mobile devices from Android 7 or iOS 11.

Dimensions: 160 x 154 x 38mm  
 Connection voltage 110–240 V AC, 50/60 Hz  
 Area covered 5 x 2.5 m at ceiling height 3 m

- F5EF3009** F5 Smart urinal sensor black  
**Mandatory accessories:**  
**ACEF3004** F5 Smart urinal duct mount (see page 98)  
**OR**  
**ACEF3003** F5 Smart urinal bowl mount - grey water (see page 98)

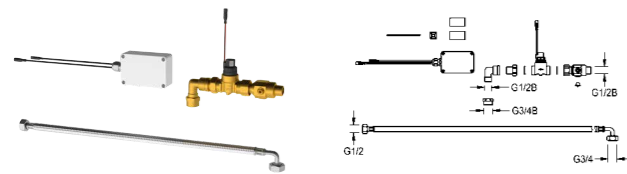

## F5 SMART URINAL UNIT FOR SINGLE BOWL - DUCT MOUNTED

F5 smart urinal unit for installation within the water inlet area of the CAMPUS urinal series. Water path pre-assembled with pipe elbows for DN 15 water connection and flushing pipe, valve assembly with water volume regulation including a strainer, solenoid valve and hose. Control unit in sealed plastic box for wireless communication with the F5 smart urinal sensor. Either for battery operation with 6 V lithium battery (CR-P2) per control unit or separate power supply via power supply unit 6.75 V/12 V DC.

Battery compartment including battery or power supply unit with extension cable must be ordered separately.

- ACEF3004** F5 Smart urinal duct mount  
**Mandatory accessories:**  
**UC00-001** Air break  
**ACEX9010** Extension cable 5m  
**F5EF3009 (black) OR F5EF3008 (white)** F5 Smart urinal sensor  
**ACEX9023 (battery) OR ACEX9001 (mains)** Power supply

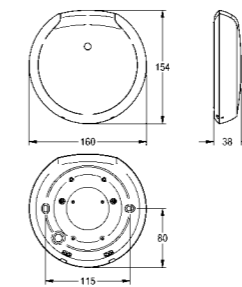

## F5 SMART URINAL SENSOR WHITE

F5 smart urinal sensor ceiling mounted for central flushing of urinal systems in a room. Multiple simultaneous user detection and touch-free triggering of flushing programmes for connected F5 smart urinal units via wireless communication. Option to connect up to 20 F5 smart urinal units. The area covered by the sensors is dependent on the ceiling height. Hygiene flushing 24 hours after last activation and saving of statistical data. Commissioning and flushing programme selection and parametrisation for each smart urinal unit via the necessary app, installed on Bluetooth®-enabled mobile devices from Android 7 or iOS 11.

Dimensions: 160 x 154 x 38mm  
 Connection voltage 110–240 V AC, 50/60 Hz  
 Area covered 5 x 2.5 m at ceiling height 3 m

- F5EF3008** F5 Smart urinal sensor white  
**Mandatory accessories:**  
**ACEF3004** F5 Smart urinal duct mount (see page 98)  
**OR**  
**ACEF3003** F5 Smart urinal bowl mount - grey water (see page 98)

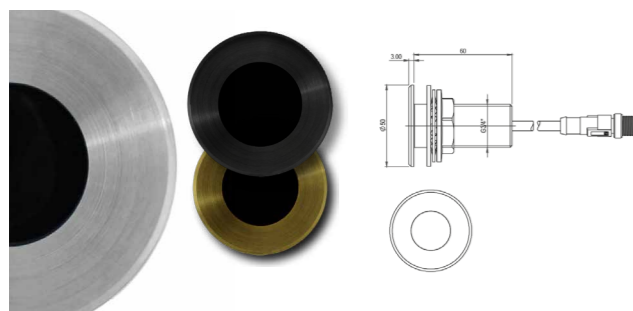

## KINGSWEAR PROGRAMMABLE URINAL SENSORS

Wall mounted programmable urinal sensor, manufactured from 316 stainless steel with a brushed finish also available as gold and black. The sensor is AIR (active infrared) and completely touch-free to promote excellent hygiene. The sensor can be fully programmed with adjustable settings including sensor range, flush times, hygiene purges and more. Dimensions: 50 x 50 x 3mm

- AC02-023** Programmable urinal sensor - Satin  
**AT10-036** Programmable urinal sensor - Black  
**AT10-038** Programmable urinal sensor - Gold  
**Mandatory accessories:**  
**AT00-221** Single station kit  
**UC00-001** Air break  
**AC01-001** Handheld programmer (one per site)  
**Complimentary accessories:**  
**AT00-222** Two station kit  
**AT00-223** Three station kit

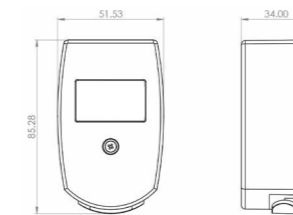

## AQUARI-SAVE URINAL CONTROL VALVE

The Aquari-Save is a programmable urinal control valve which grants the user full control over the release of water. This aids in water saving by reducing unnecessary water release outside standard facility use through extensive programmable options. The programmer will set the water usages at equal time distances of time within the pre-set first and last flush time, for example, if you set 6 flushes in 6 hours, it will flush once per hour. The valve is supplied with pre-set flushing times that can be altered via programmer.

Supplied with handheld programmer.  
 Dimensions: 51 x 85 x 34mm

- UC99-034** Aquari-save urinal control unit with programmer  
**Complimentary accessory:**  
**AC04-046** Aquari-save additional unit without programmer

# Urinal flushing

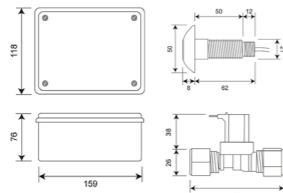

## URINAL CONTROL SYSTEM - SINGLE STATION

Urinal control system single station kit supplied with one standard sensor with  $\varnothing 50\text{mm}$  bezel. The sensor activates a flush when the user walks away.

The single station kit includes:

- 1 x Mains control box
- 1 x Solenoid valve
- 1 x Sensor with 50mm bezel

**UC07-010** Urinal control system - single station

**Mandatory accessories:**

**UC00-001** Air-break valve

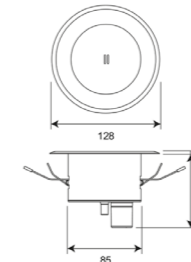

## FLUSHMATIC DOWNLIGHTER KIT - MULTIPLE BOWLS

Flushmatic urinal control for use with multiple station urinals, manufactured from ABS. The downlighter kit is designed to be ceiling mounted. The control is activated by the passive infrared (PIR) detector which detects movement within the sensing area, switching the unit into a timing mode. After a pre-set time, the solenoid valve opens allowing water to flow into the cistern activating the flushing cycle.

Dimensions: 128 x 128 x 86mm  
Requires KWC DVS cistern.

**UC01-018** Flushmatic downlighter kit - battery

**UC01-024** Flushmatic downlighter kit - mains

**Mandatory accessories:**

**F3048** Concealed cistern for Flushmatic 9L

**OR**

**F3049** Concealed cistern for Flushmatic 13.5L

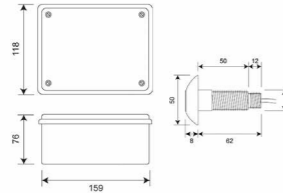

## URINAL CONTROL SYSTEM - TWO STATION

Urinal control system two station kit supplied with two standard sensors that are supplied with  $\varnothing 50\text{mm}$  bezel. The sensor activates a flush when the user walks away.

The two station kit includes:

- 1 x Mains control box
- 2 x Solenoid valves
- 2 x Sensors with 50mm bezels

**UC07-011** Urinal control system - two station

**Mandatory accessories:**

**UC00-001** Air-break valve

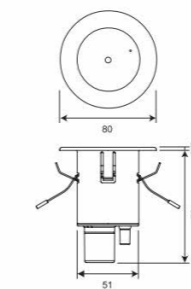

## FLUSHMATIC PEARL SOLO - SINGLE BOWL

The ceiling mounted Pearl Solo Flushmatic urinal control is used for single station urinals. This works by using a passive infrared (PIR) detector which detects movement within the sensing area, switching the unit into a timing mode. After a pre-set time, the solenoid valve opens allowing water to flow into the cistern activating the flushing cycle. The flush time can be customised by the user turning the rotary switch on the Flushmatic board.

**UC01-027** Flushmatic pearl solo - mains

**Mandatory accessories:**

**UC00-001** Air-break valve

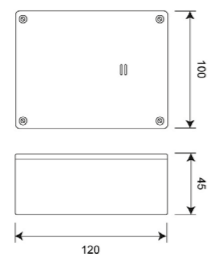

## FLUSHMATIC URINAL CONTROL - MAINS

Flushmatic urinal control, manufactured from ABS plastic (control box). Designed for use with multiple station urinals and to be surface mounted. The control uses a passive infrared (PIR) detector which detects movement within the sensing area, switching the unit into a timing mode. After a pre-set time, the solenoid valve opens allowing water to flow into the cistern activating the flushing cycle. The fill-time for the cistern can be customised by the user using the appropriate switches on the Flushmatic board.

Supplied with mains power supply 240 V AC  
Dimensions: 120 x 100 x 45

**UC01-017** Flushmatic urinal control - mains

**Mandatory accessories:**

**F3048** Concealed cistern for Flushmatic 9L

**OR**

**F3049** Concealed cistern for Flushmatic 13.5L

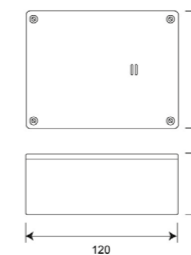

## FLUSHMATIC URINAL CONTROL - BATTERY

Flushmatic urinal control, manufactured from ABS plastic (control box). Designed for use with multiple station urinals and to be surface mounted. The control uses a passive infrared (PIR) detector which detects movement within the sensing area, switching the unit into a timing mode. After a pre-set time, the solenoid valve opens allowing water to flow into the cistern activating the flushing cycle. The fill-time for the cistern can be customised by the user using the appropriate switches on the Flushmatic board.

Supplied with battery kit 6V DC  
Dimensions: 120 x 100 x 45

**UC01-005** Flushmatic urinal control - battery

**Mandatory accessories:**

**F3048** Concealed cistern for Flushmatic 9L

**OR**

**F3049** Concealed cistern for Flushmatic 13.5L



## WCs

KWC DVS range of stainless steel and ceramic WCs have been designed to transform your washroom experience into one of luxury and innovation.

Crafted with precision and built to last, our stainless steel and ceramic WCs combine aesthetic appeal with unparalleled durability. Whether you're seeking a sleek, contemporary look or a timeless classic design, our collection offers a wide array of options to cater to your unique style preferences.

Complete your washroom with our range of touch-free WC flush valves. Designed to revolutionise the washroom experience, our flush valve kits and programmable sensors offer a multitude of benefits that elevate hygiene standards, provide unparalleled convenience and promote sustainability.

# WCs

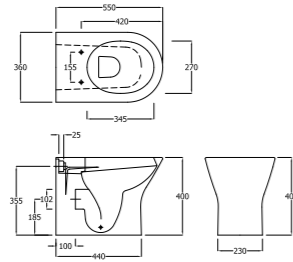

### LANGLEY BACK TO WALL RIMLESS CERAMIC WC PAN

Rimless back to wall wc pan, manufactured from high quality vitreous china to BS 340. With minimalistic design allowing for easy cleaning and maintenance. Rimless flushing for unrivalled hygiene and an effective silent flush using less water. Compatible with concealed cistern, tested with flush volume as low as 4/2.6ltr dual flush for water saving

Standard height and projection pan  
Seat not included  
Dimensions: 360 x 400 x 550mm

**SW00-076** Ceramic WC

**Mandatory accessories:**

**WC02-011** 1 1/2" Cistern kit

**SW00-077** Soft close toilet seat & cover

OR

**SW00-078** Slim soft close toilet seat & cover

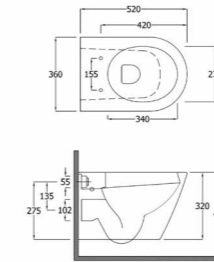

### LANGLEY WALL HUNG RIMLESS TOILET PAN

Wall hung rimless WC pan, manufactured from high quality vitreous china to BS 340. With an innovative rimless hygienic design, making the pan easier to clean, whilst conserving water. Wall hung installation reduces dirt traps. Compatible with concealed cistern, tested with flush volume as low as 4/2.6ltr dual flush for water saving.

Complies to BS EN 997:2018

Seat not included

Dimensions: 360 x 320 x 520mm

**SW00-079** Rimless WC pan

**Mandatory accessories:**

**AQFX0006** Installation frame and cistern

**SW00-077** Soft close toilet seat & cover

OR

**SW00-078** Slim soft close toilet seat & cover

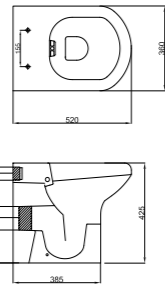

### CHARTHAM CERAMIC WC

Rimless back to wall WC pan, manufactured from high quality vitreous china to BS 340. Sits at a comfort height of 450mm from floor to top of seat. Designed with a sleek easy to clean style and rimless flush to prevent bacteria from building. The rimless technology also offers an effective silent flush using less water

Seat is not included (see options below)  
Dimensions: 360 x 425 x 520mm

**SW00-028** Ceramic WC

**Mandatory accessories:**

**WC02-011** 1 1/2" Cistern kit

**SW00-033** White seat and soft close cover

OR

**SW00-034** White seat only

OR

**SW00-035** Blue seat only

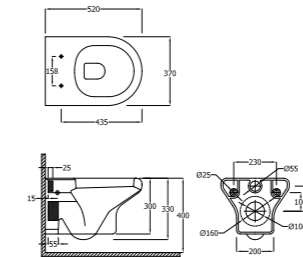

### CHARTHAM WALL HUNG CERAMIC WC

Wall hung WC pan. Manufactured from high quality vitreous china to BS 3402. With an innovative rimless hygienic design, making the pan easier to clean, whilst conserving water. Wall hung installation reduces dirt traps. Compatible with concealed cistern,

Dimensions: 370 x 400 x 520mm

**SW00-026** Wall hung WC

**Mandatory accessories:**

**AQFX0006** Installation frame and cistern

**SW00-033** White seat and soft close cover

OR

**SW00-034** White seat only

OR

**SW00-035** Blue seat only

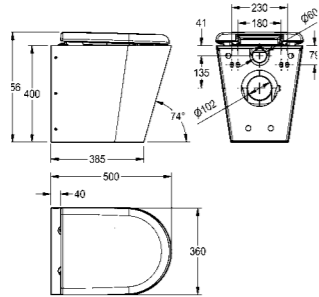

### CAMPUS FLOOR STANDING WC PAN WITH SEAT AND LID

Floor standing WC pan with shroud to the floor, stainless steel, surface satin finished, material thickness 1,5mm, flushing certificated to EN 997, concealed flushing rim with min. 4 litre flushing capacity, with a shrouded 100mm diameter horizontal 'P' trap outlet, pressed seat area tapered towards centre, all edges curved, fixing with included mounting plate conform to EN 33, including safety screws. 4 litre flush EN997 approved.

Dimensions: 360 x 456 x 500mm

**CMPX597BN** With black seat and lid

**CMPX597WN** With white seat and lid

**CMPX597GN** With grey seat and lid

**AQFX0006** Installation frame and cistern

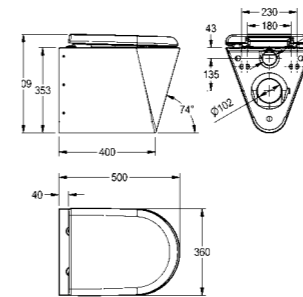

### CAMPUS WALL HUNG WC PAN WITH SEAT AND LID

Wall hung WC pan, stainless steel, surface satin finished, material thickness 1,5mm, flushing certificated to EN 997, concealed flushing rim with min. 4 liter flushing capacity, with a shrouded 100mm diameter horizontal 'P' trap outlet, pressed seat area tapered towards centre, all edges curved, fixing with mounting plate supplied, conform to EN 33, includes security screws. 4 litre flush EN997 approved.

Dimensions 360 x 409 x 500mm

**Options:**

**CMPX592BN** With black seat and lid

**CMPX592WN** With white seat and lid

**CMPX592GN** With grey seat and lid

**Mandatory accessories:**

**AQFX0006** Installation frame and cistern



# WC flushing

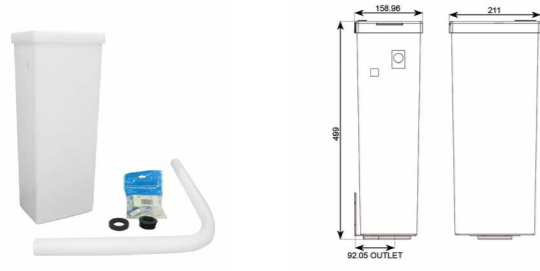

### CONCEALED PLASTIC CISTERN KIT – VERTICAL

Concealed vertical cistern kit, manufactured from ABS. Designed to be wall mounted. Complete with WRAS approved side entry valve. KWC DVS vertical cisterns are designed to improve flush velocity when compared to traditionally shaped cisterns, with the added benefit of providing more service space either side of the cistern for a more professional installation. Kit includes:

- 1 x WRAS approved side entry valve
- 1 x flush pipe
- 1 x back to pan connector
- 1 x concealed vertical cistern

Cistern Dimensions: 221 x 499 x 159mm (W x H D)

- WC02-013** 1 1/2" Cistern kit
- WC02-014** 2" Cistern kit



### CONCEALED PLASTIC CISTERN KIT

Concealed cistern kit, manufactured from ABS. Designed to be wall mounted. Complete with WRAS approved side entry valve. Kit includes:

- 1 x WRAS approved side entry valve
- 1 x flush pipe
- 1 x back to pan connector
- 1 x concealed cistern
- 1 x blanking plug

Cistern Dimensions: 495 x 330 x 150mm (W x H D)

- WC02-011** 1 1/2" Cistern kit
- WC02-012** 2" Cistern kit



### COMPACT CONCEALED PLASTIC CISTERN KIT

Black compact cistern kit, manufactured from ABS. Designed to be wall mounted. Complete with WRAS approved side entry valve. Kit includes:

- 1 x WRAS approved side entry valve
- 1 x flush pipe
- 1 x back to pan connector
- 1 x concealed cistern
- 1 x blanking plug

Cistern Dimensions: 410 x 295 x 135mm (W x H D)

- WC02-017** 1 1/2" Cistern kit

### WC FLUSHVALVE SPARES

- WC01-022** Flushvalve with in-built overflow (valve only) - 1 1/2"
- WC01-023** Flushvalve with in-built overflow (valve only) - 2"
- WC01-032** Manual Override Flushvalve with in-built overflow (valve only) - 1 1/2" base
- WC01-033** Manual Override Flushvalve with in-built overflow (valve only) - 2" base
- WC01-012** Flushvalve with in-built overflow (base only) - 1 1/2" base
- WC01-013** Flushvalve with in-built overflow (base only) - 2" base

- WC01-002** Replacement body
- WC00-001** Replacement stainless steel piston & spring
- WC00-003** Replacement spring only - suitable for all models
- WC00-002** Replacement piston & spring for manual override
- WC00-010** Control box (PCB) C/W 1.5m cable
- WC00-008** Control box (V3 Battery) C/W 1.5m cable
- WC00-012** Control box (Low Voltage Mains) C/W 1.5m cable
- WC00-155** Enclosure, Intelligent charger & battery pack
- WC00-129** Flush Flow Restrictor - 2" Flush pipe

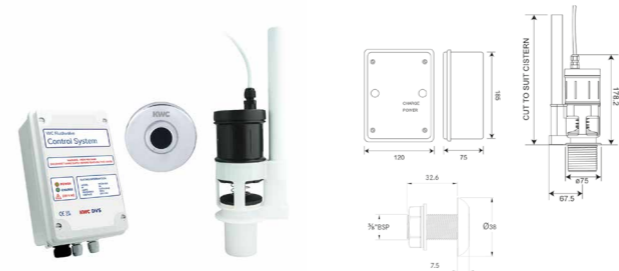

### WC FLUSHVALVE KIT - WAVE-ON

Touch-free WC flushing system with an electronically operated drop valve that replaces the traditional syphon and delivers a WRAS approved 4 litre single flush from the cistern to the lavatory bowl.

Kit includes:

- 1 x Flushvalve
- 1 x Wave on sensor
- 1 x Control box

- WC03-002** With 1 1/2" base - mains
- WC03-003** With 2" base - mains
- WC03-050** With 1 1/2" base - battery
- WC03-051** With 2" base - battery

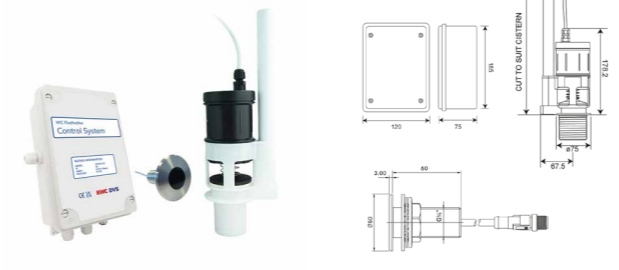

### PROGRAMMABLE SENSOR WC FLUSH VALVE KIT

Programmable sensor WC flush valve kit. Designed with WRAS approved 4 litre single flush and programmable sensor. Fits to new and existing WC cisterns.

- WC03-013** With 1 1/2" base - mains
- WC03-014** With 2" base - mains
- WC03-017** Mains - for use with AQFX frame
- WC03-052** With 1 1/2" base - battery
- WC03-053** With 2" base - battery
- WC03-019** Battery - for use with AQFX frame

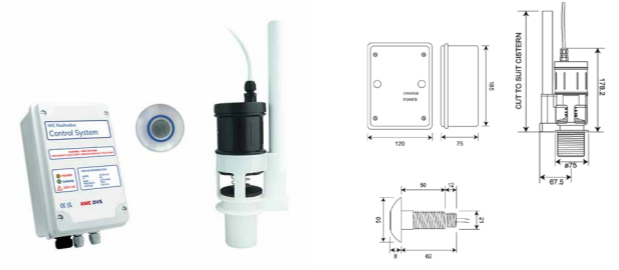

### WC FLUSHVALVE KIT WITH TACTILE SWITCH

The WC flushing system is an electronically operated drop valve which replaces the traditional syphon and delivers a WRAS approved 4L single flush from the cistern to the lavatory bowl.

Kit includes:

- 1 x Flushvalve
- 1 x Tactile switch
- 1 x Control box

- WC03-028** With 1 1/2" base - mains
- WC03-029** With 2" base - mains
- WC03-063** With 1 1/2" base - battery

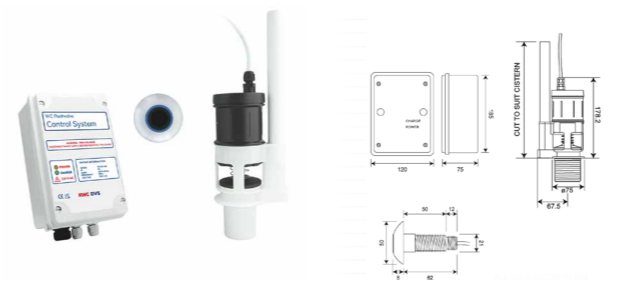

### ANTI-VANDAL WC FLUSHVALVE KIT - WAVE-ON

WC flushing system with an electronically operated drop valve that replaces the traditional syphon and delivers a WRAS approved 4 litre single flush from the cistern to the lavatory bowl.

Kit includes:

- 1 x Flushvalve
- 1 x Tactile wave on sensor
- 1 x Control box

- WC03-022** With 1 1/2" base - mains
- WC02-023** With 2" base - mains

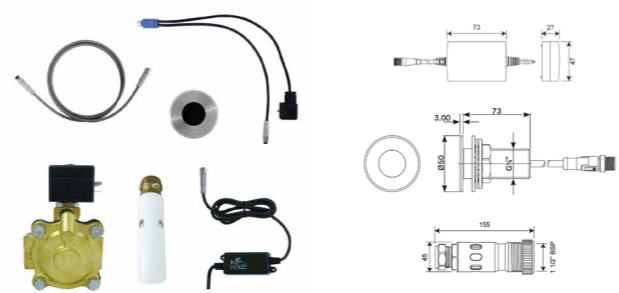

### PROGRAMMABLE DIRECT FLUSHING KIT

Direct flushing kit for environments where the traditional fitting of a cistern is not desired, or not possible. The cistern in this setup is replaced with a direct flushing, mains fed solenoid valve, including an air break to prevent backflow. Kit consists of:

- 1 x Programmable WC Sensor
- 1 x M8 (Y splitter)
- 1 x M8 3m Cable Extension
- 1 x Air Break
- 1 x 6v DC ASCO Valve
- 1 x M8 (Y splitter)
- 1 x Air break
- 1 x PSU

- WC03-043** Programmable direct flushing kit

# WC frame flushing system

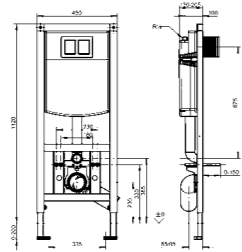

### AQUAFIX INSTALLATION FRAME FOR WC PAN

AQUAFIX installation element for wall-mounted toilet bowl, with wall-installation cistern. Self-supporting, powder coated steel-frame construction, TÜV tested, for individual mounting for dry-wall lining. Concealed toilet cistern with water condensation insulation, with dual-volume flushing (7,5-4,5 l or 4-2 l) or Start/Stop flushing, triggering function transferred via flexible pressure spirals, charge valve noise group I, mounting bracket 4-fold adjustable for toilet-connecting elbow DN 90 / DN 100, complete with flexible connecting hose, toilet-connecting elbow, retaining bolts for toilet, building protection and fastening material.

Dimensions: 450 x 1120mm (W x H)  
Requires WC03-017 flush valve kit or manual flush plate to operate

**AQFX0006** Installation frame

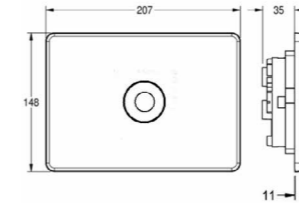

### AQUAFIX FLUSHING PLATE - PROGRAMMABLE SENSOR

Flushing plate for AQUAFIX wall-installation cistern, operation from front. Compatible with the AQUAFIX installation frames and the programmable flush valve kits listed below. Includes fixing bolts and securing screw, made of stainless steel.

Dimensions: 207 x 148 x 14mm

**2000105718** AQUAFIX flushing plate - programmable sensor

**Mandatory accessories:**

**WC03-017** Mains - for use with AQFX frame

**OR**

**WC03-019** Battery - for use with AQFX frame

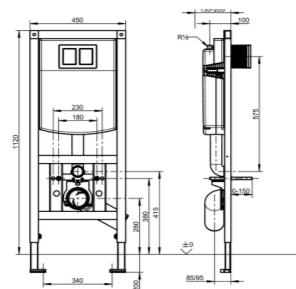

### AQUAFIX INSTALLATION FRAME FOR WC PAN BARRIER FREE

AQUAFIX installation frame for barrier-free wall-mounted toilet bowl, with wall-installation cistern. Self-supporting, powder coated steel-frame construction, TÜV tested, for individual mounting for dry-wall lining. Concealed toilet cistern with water condensation insulation, with dual-volume flushing (7,5-4,5 l or 4-2 l) or Start/Stop flushing, triggering function transferred via flexible pressure spirals, charge valve noise group I, mounting bracket 4-fold adjustable for toilet-connecting elbow DN 90 / DN 100, complete with flexible connecting hose, toilet-connecting elbow, retaining bolts for toilet, building protection and fastening material.

Dimensions 450 x 1120 mm (Wx H)

**AQFX0007** Installation frame, barrier-free

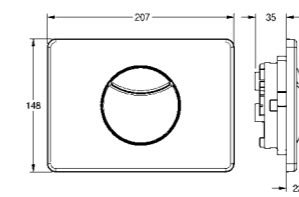

### AQUAFIX FLUSHING PLATE - DUAL FLUSH

Flushing plate for AQUAFIX wall-installation cistern, operation from front, 2-level flushing or start/stop flushing, consisting of operating button, button mounting, installation frame, fixing bolts and securing screw, made of stainless steel.

Dimensions: 207 x 148 x 22mm

**AQUA555** AQUAFIX flushing plate - dual flush

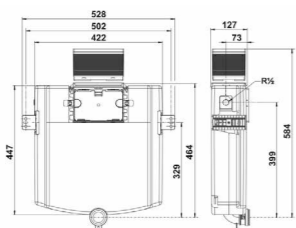

### AQUAFIX INSULATED CONCEALED CISTERN KIT

AQUAFIX Concealed cistern with front access, height: 820 mm, insulated against condensation, with dual flush (6l/3l), button function transmitted to AQUAFIX flush valve via flexible cables, connection to push plate via turn-click connection, flush pipe bend with protection cap, AQUAFIX fill valve Noise Class I, angle valve R 1/2, protection box for access opening can be cut to size, with fixing brackets, without fastenings, packed in a box concealed cistern tested to DIN EN 14055, Noise Class I

**FLSY0003** Aquafix cistern kit 1 1/2"

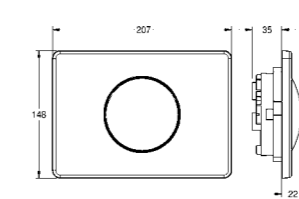

### AQUAFIX FLUSHING PLATE - SINGLE FLUSH

Flushing plate for AQUAFIX wall-installation cistern, operation from front, consisting of operating button, button mounting, installation frame, fixing bolts and securing screw, made of stainless steel.

Dimensions: 207 x 148 x 22mm

**AQUA557** AQUAFIX flushing plate - single flush



# NEW The Kingswear WC flushing

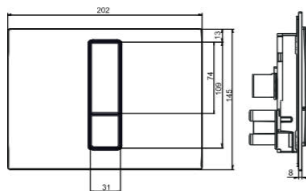
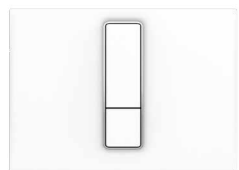

## KINGSWEAR PUSH PLATE WHITE

Kingswear Push plate white for Aquafix frames & cisterns with small access opening, dual flush, consisting of actuator element incl. chromed decorative frame, cover plate and fixing bolts, packed in a box

Material: plastic/white

**AQUA562** Kingswear push plate

**Mandatory accessories:**

**AQFX0006** Installation frame

OR

**AQFX0007** Installation frame, barrier-free

OR

**FLSY0003** Aquafix cistern kit 1 1/2"

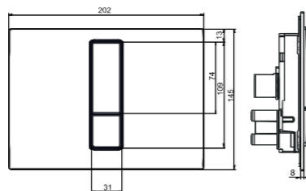
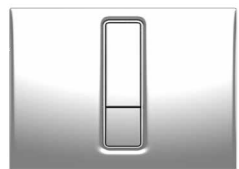

## KINGSWEAR PUSH PLATE CHROME

Kingswear Push plate chrome for Aquafix frames & cisterns with small access opening, dual flush, consisting of actuator element incl. chromed decorative frame, cover plate and fixing bolts, packed in a box

Material: plastic/chrome

**AQUA563** Kingswear push plate

**Mandatory accessories:**

**AQFX0006** Installation frame

OR

**AQFX0007** Installation frame, barrier-free

OR

**FLSY0003** Aquafix cistern kit 1 1/2"

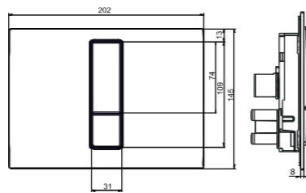

## KINGSWEAR PUSH PLATE SATIN

Kingswear Push plate satin for Aquafix frames & cisterns with small access opening, dual flush, consisting of actuator element incl. chromed decorative frame, cover plate and fixing bolts, packed in a box

Material: plastic/satin

**AQUA564** Kingswear push plate

**Mandatory accessories:**

**AQFX0006** Installation frame

OR

**AQFX0007** Installation frame, barrier-free

OR

**FLSY0003** Aquafix cistern kit 1 1/2"

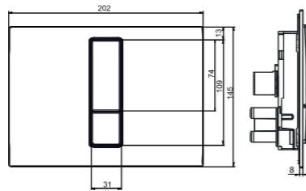

## KINGSWEAR PUSH PLATE MATT BLACK

Kingswear Push plate matt black for Aquafix frames & cisterns with small access opening, dual flush, consisting of actuator element incl. chromed decorative frame, cover plate and fixing bolts, packed in a box

Material: plastic/matt black

**AQUA565** Kingswear push plate

**Mandatory accessories:**

**AQFX0006** Installation frame

OR

**AQFX0007** Installation frame, barrier-free

OR

**FLSY0003** Aquafix cistern kit 1 1/2"



Stainless style

# Kingswear programmable WC flushing kits



## **KINGSWEAR PROGRAMMABLE WC FLUSHVALVE KIT - BLACK**

Programmable sensor WC flush valve kit. Designed with WRAS approved 4 litre single flush and programmable sensor. Fits to new and existing WC cisterns.

**AT10-039** Programmable Flush WC Sensor - Black



## **KINGSWEAR PROGRAMMABLE WC FLUSHVALVE KIT - GOLD**

Programmable sensor WC flush valve kit. Designed with WRAS approved 4 litre single flush and programmable sensor. Fits to new and existing WC cisterns.

**AT10-041** Programmable Flush WC Sensor - Gold



## **KINGSWEAR PROGRAMMABLE WC FLUSHVALVE KIT - SATIN**

Programmable sensor WC flush valve kit. Designed with WRAS approved 4 litre single flush and programmable sensor. Fits to new and existing WC cisterns.

**AC02-023** Programmable Flush WC Sensor - Satin

### **PROGRAMMABLE**

Options include adjustable run-on times, sensor range, hygiene purges and more.

### **COMPATIBLE**

Programmable sensors are compatible with all DVS electronic taps, showers, WCs and urinals ranges.

### **COLOURFUL**

The sensors have been designed to match the range of colourful taps. Available in gold, satin and black with a brushed finish. The traditional stainless colour is also available.

### **EFFICIENT**

Real time data captured from the intelligent sensors can be uploaded using the DVS branded hand held programmer via the USB port. Allowing accurate monitoring of water efficiency.

### **HYGIENIC**

The sensors promote excellent hygiene in any washroom environment and are completely touch-free. A simple hand wave motion will activate the sensor.

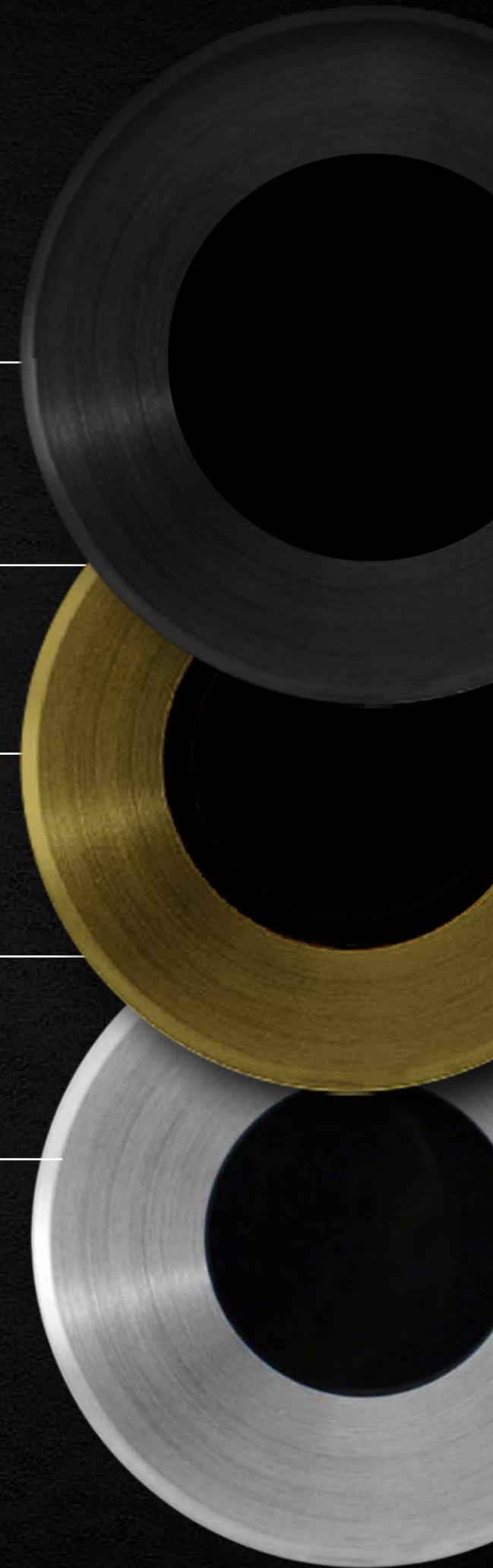



## Showers

In public buildings, showers are crucial in providing comfort and cleanliness. Whether within corporate domains, bustling football stadiums, healthcare havens, or secure facilities, KWC presents an array of shower solutions that epitomise efficiency and innovation. At KWC DVS, we recognise the distinctive demands of various settings. Our electronic and programmable shower towers present advanced features and tailor-made customisation for those seeking cutting-edge functionality. On the other hand, our self-closing thermostatic and lever versions prioritise simplicity without compromising quality.

Whether optimising experiences within sleek office complexes or ensuring optimal sanitation within healthcare sanctuaries, our shower solutions cater to your requirements. Experience the fusion of technology, design, and versatility with KWC DVS – where every shower is a statement of excellence.

# F5 Shower towers

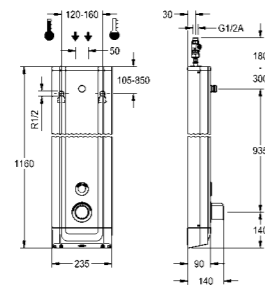

## F5E THERM STAINLESS STEEL SHOWER PANEL

F5S Therm shower panel manufactured from stainless steel with self-closing thermostatic mixer. Designed with integrated self-closing cartridge, thermostat and pre-assembled hygiene unit including sensor with control electronics to perform automatic water hygiene flushing, program-controlled thermal disinfection (additional bypass solenoid-operated flush valve cartridge required) and storage of statistical data. Activated water hygiene flushing at fixed intervals of 24 hours. Option to set parameters with the bidirectional remote control. Optional hygiene unit for battery operation with 6 V lithium battery per fitting or separate power supply via plug-in power supply unit 6.75 V/12 V DC. Shower head and battery compartment including battery or plug-in power supply unit with extension cable to be ordered separately.

Complete with 9.0 l/min comfort shower head  
Dimensions: of housing 235 x 1160 x 100mm

**3600002408**

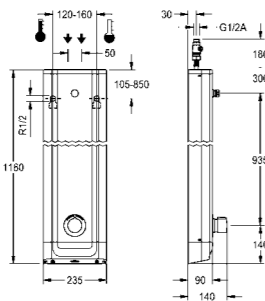

## F5S-MIX STAINLESS STEEL SHOWER PANEL - MAINS

F5S Mix shower panel manufactured from stainless steel for wall mounting with DN 15 self-closing single control mixer. FRAMIC self-closing mixing cartridge, hydraulically controlled, low maintenance and stagnation free, with ceramic disc technology, self-closing, flow pressure independent due to the medium-independent design. Stepless adjustment of flow duration. With adjustable, turn-proof temperature stop. Housing made of stainless steel with raised function surface and plastic cover caps. Connecting hoses with lockable water volume control with backflow preventer and strainer.

Complete with 9.0 l/min comfort shower head  
Dimensions: 1160 x 235 x 90mm

**3600002410**

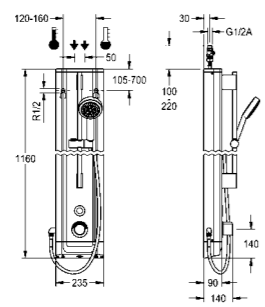

## F5E SHOWER PANEL WITH HAND SHOWER FITTING

F5E Therm shower panel made of stainless steel for wall mounting with thermostatic mixer and a hand shower fitting. Electrically controlled, for connection to hot water and cold water. Shower valve with integrated solenoid valve cartridge, thermostat and mechanism for optional bypass solenoid valve cartridge to perform program-controlled thermal disinfection. Thermostat with metal handle, an adjustable and turn-proof temperature stop and an option for manual thermal disinfection. Button sensor including control electronics with start/stop function and deactivation for cleaning. Activated water hygiene flushing 24 hours after last activation and saving of statistical data. With option for parameterization and communication via the optional bidirectional remote control. Battery operation with 6 V lithium battery (CR-P2) per fitting, separate power supply via plug-in power supply unit 6.75 V / 12 V DC or AQUA3000 open system accessories.

Dimensions: of housing 235 x 1160 x 90mm  
Battery compartment including battery or plug-in power supply unit with extension cable to be ordered separately.

**SH99-101**

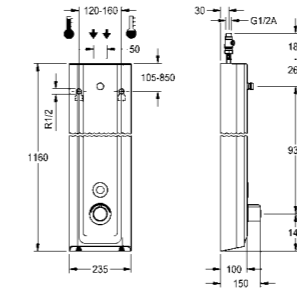

## F5E-THERM MIRANIT SHOWER PANEL - MAINS

F5E Therm shower panel manufactured from Miranit for wall mounting with thermostatic mixer. Electrically controlled, for connection to hot water and cold water. thermostat and mechanism for optional bypass solenoid valve cartridge to perform program-controlled thermal disinfection. Button sensor including control electronics with start/stop function and deactivation for cleaning. Connecting hoses with lockable water volume control with backflow preventer and strainer. Activated water hygiene flushing 24 hours after last activation and saving of statistical data. Programmable options available via the optional bidirectional remote control.

Complete with 9.0 l/min comfort shower head  
Integrated solenoid valve  
Battery operation: 6 V lithium battery  
Power supply unit with extension cable to be ordered separately.  
Dimensions: 1160 x 235 x 100mm

**3600002409**

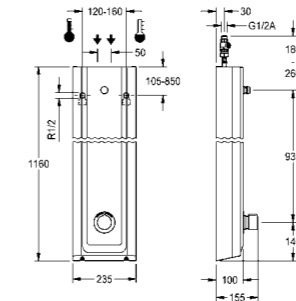

## F5S MIX MIRANIT SHOWER PANEL

F5S Mix shower panel made of mineral material for wall mounting with DN 15 self-closing single control mixer. FRAMIC self-closing mixing cartridge, hydraulically controlled, low maintenance and stagnation free, with ceramic disc technology, self-closing, flow pressure independent due to the medium-independent design. Stepless adjustment of flow duration. With adjustable, turn-proof temperature stop. For connection to hot water and cold water. All-metal construction, visible parts high-polished or chrome-plated. Housing with raised function surface made of MIRANIT resin-bonded mineral material with pore-free smooth surface (temperature-resistant up to 80 °C), Alpine white colour. Connecting hoses with lockable water volume control with backflow preventer and strainer.

Complete with 9.0 l/min comfort shower head  
Dimensions: 235 x 1160 x 100mm

**3600002411**

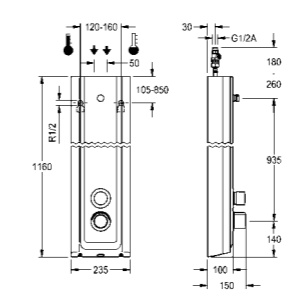

## F5S THERM MIRANIT SHOWER PANEL

Shower panel manufactured from Miranit with a self-closing thermostatic mixer. Designed with integrated self-closing cartridge, thermostat and pre-assembled hygiene unit. Includes connecting hoses with lockable water volume control and backflow preventer and strainer. Activated water hygiene flushing at fixed intervals of 24 hours. Option to set parameters using the optional bidirectional remote control. Optional hygiene unit for battery operation with 6 V lithium battery per fitting or separate power supply via plug-in power supply unit 6.75 V / 12 V DC. Shower head and battery compartment including battery or plug-in power supply unit with extension cable to be ordered separately.

Complete with 9.0 l/min comfort shower head  
Dimensions: of housing 235 x 1160 x 100mm

**SH99-100**

# Showers

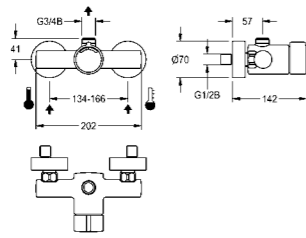

### F3S-MIX SELF-CLOSING - PIPE

F3S-Mix self-closing wall-mounted shower mixer DN 15. Self-closing mixing cartridge, hydraulically controlled, piston-free design, self-closing, stepless configuration of flow duration. With adjustable temperature stop. Connects to hot and cold water. G 3/4 B for installation of bent outlet or surface-mounted shower pipe, high-polished chromium-plated brass. With adjustable connections, with backflow preventer, strainers and screw rosettes.

<b>F3SM2001</b>	Mixer for pipe connection
<b>Mandatory accessories:</b>	
<b>ACSX2001</b>	Shower pipe
<b>AQUA757</b>	Aquajet - slimline showerhead
<b>OR</b>	
<b>SHAC0008</b>	Aquajet - comfort showerhead

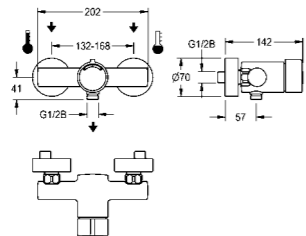

### F3S-MIX SELF-CLOSING - HOSE

F3S-Mix self-closing wall-mounted shower mixer DN 15. Self-closing mixing cartridge, hydraulically controlled, piston-free design, self-closing, stepless configuration of flow duration. With adjustable temperature stop. Connects to hot and cold water. G 3/4 B for installation of bent outlet or surface-mounted shower pipe, high-polished chromium-plated brass. With adjustable connections, with backflow preventer, strainers and screw rosettes.

<b>F3SM2002</b>	Mixer for hose connection
<b>Mandatory accessories:</b>	
<b>ACXX2008</b>	Shower bracket
<b>26.000.111.040</b>	Hand shower head
<b>26.001.003.000</b>	Shower hose

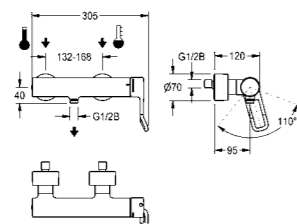

### F4LT-MED THERMOSTATIC SINGLE-LEVER MIXER

F4LT-Med thermostatic lever mixer, thermostat-controlled mixer cartridge with expansion element & active scald protection, fail-safe against backflow as well as adjustable & turn-proof temperature stop, & ceramic disc technology. Optimised for cleaning, scald-protected, safe-touch housing with hand shower connection, G 1/2 B. All-metal construction, polished chromium-plated brass. Decoupled from the tap housing, volume-reduced, smooth water flow from low-lead brass (lead proportion ≤ 0.2%), & without nickel coating. With thermal insulation components to reduce heat transfer from the tap housing to the cold-water line. Includes strainers & fully covered by depth-adjustable screw rosettes.

<b>F4LT2003</b>	Shower mixer
<b>Mandatory accessories:</b>	
<b>ACXX2008</b>	Shower bracket
<b>26.000.111.040</b>	Hand shower head
<b>26.001.003.000</b>	Shower hose



# Showers

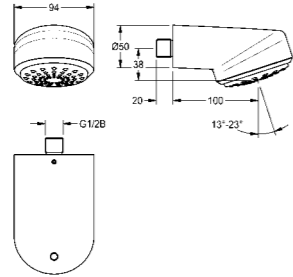

### AQUAJET-COMFORT SHOWER HEAD FOR WALL CONNECTION

AQUAJET-Comfort DN 15 shower head with plastic jet face continuously adjustable between 13–23°, anti-limescale system and low aerosol formation. For wall connector with insertable connecting nozzle, diameter 26mm, high-polished chrome-plated brass housing, with integrated flow regulator 9.0 l/min, ready for installation of anti-twist protection.

Also suitable for shower trays, 800 x 800mm

**SHAC0013** Aquajet - comfort showerhead

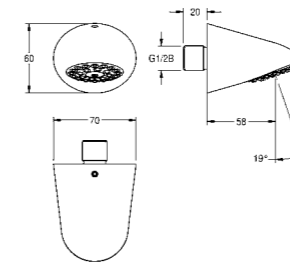

### AQUAJET-SLIMLINE SHOWER HEAD FOR WALL CONNECTION

AQUAJET-Slimline shower head DN 15 with plastic jet face with anti-calcification system and low aerosol formation, for wall connection, polished chromium-plated brass. With flow controller 9.0 l/min.

**AQUA751** Aquajet - slimline showerhead

**Mandatory accessories:**

**ESHHE0002** Flow controller 12.0l/Min

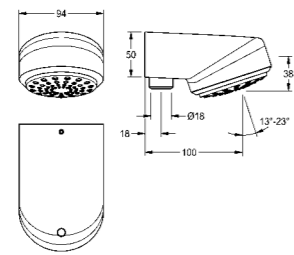

### AQUAJET-COMFORT SHOWER HEAD BOTTOM INLET

AQUAJET-Comfort shower head DN 15 with infinitely angle-adjustable plastic jet face 13° - 23°, anti-calcification system and low aerosol formation. Model for surface pipe installation 18mm and enclosed flow controllers 6.0 l/min, 9.0 l/min and 12.0 l/min. Housing polished chromium-plated brass. Also suitable for shower trays, 800 x 800mm.

**SHAC0008** Aquajet - comfort showerhead

**Mandatory accessories:**

**ACSX2001** Shower pipe

**F3SV2001** Self-closing shower

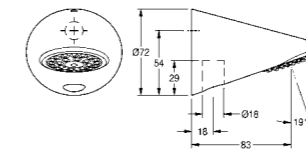

### AQUAJET-SLIMLINE SHOWER HEAD BOTTOM INLET

AQUAJET-Slimline shower head DN 15 with plastic jet face with anti-calcification system and low aerosol formation, for surface pipe mounting, polished chromium-plated brass. With flow controllers 9.0 l/min and 12.0 l/min.

Spout projection: 83mm

Head Dimensions: 72 x 72 x 83mm

**AQUA757** Aquajet - slimline showerhead

**Mandatory accessories:**

**ACSX2001** Shower pipe

**F3SV2001** Self-closing shower

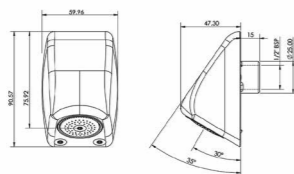

### ANTI-MICROBIAL SHOWERHEAD

Anti-microbial showerhead manufactured from brass with a chrome finished cover. Supplied with removable waterway that is manufactured in four different colours with anti-microbial Biomaster silver ion technology. The ligature resistant heads also feature a one-piece anti-microbial ABS outlet.

Requires sensor and station kit to operate

Additional TMV3 required

Dimensions: 60 x 90 x 47mm

**SH07-095** Anti-microbial showerhead

**Complimentary accessories:**

**SH00-070** Replacement Coloured Waterways (Set of 4)

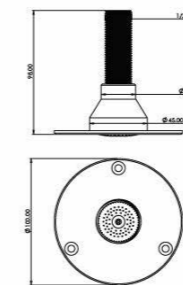

### FLUSH MOUNTED CEILING SHOWERHEAD

An Aesthetically pleasing take on Ceiling Height Showerheads whilst maintaining Ligature & Vandal Resistant Design. Ceiling Height High-Security Shower Head with a One-Piece Anti-Microbial ABS outlet. Anti-ligature design, with a tamper-proof security locking screw. Brushed Stainless Steel finish.

Additional TMV3 required

Sensor and station kit required

**SH07-047** Flush mounted ceiling showerhead

# Showers

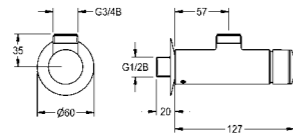

### F3S SELF-CLOSING BIB TAP

F3S self-closing bib tap DN 15 for shower facilities. Hydraulically controlled, piston-free design, self-closing, stepless adjustment of flow duration. For connection to pre-mixed hot water or cold water. Housing including changeable valve seat, with outlet on top, G 3/4 B, for installation of surface-mounted shower pipe, high-polished chromium-plated brass. Dimensions: 60 x 60 x 127mm.

- |                               |                               |
|-------------------------------|-------------------------------|
| <b>F3SV2001</b>               | Self-closing bib tap          |
| <b>Mandatory accessories:</b> |                               |
| <b>ACSX2001</b>               | Shower pipe                   |
| <b>AC17-047</b>               | TMV3                          |
| <b>SHAC0008</b>               | Aquajet - comfort showerhead  |
| OR                            |                               |
| <b>AQUA757</b>                | Aquajet - slimline showerhead |

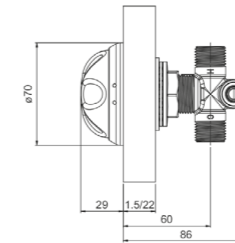

### LIGATURE RESISTANT TEMPERATURE BLENDING VALVE ADJUSTER

Temperature blending valve adjuster, manufactured from brass with a chrome finish. Designed to be robust with good aesthetics and therefore suits all applications. Manufactured with a robust construction and tamper proof design. Easy to install.

External TMV3 required  
Dimensions: 70 x 70mm (W x H)

- |                               |  |
|-------------------------------|--|
| <b>SH00-011</b>               | Wall thickness compatibility 1.5mm - 22mm  |
| <b>SH00-012</b>               | Wall thickness compatibility 22mm - 180mm  |
| <b>SH00-013</b>               | Wall thickness compatibility 180mm - 280mm |
| <b>Mandatory accessories:</b> |  |
| <b>AC17-047</b>               | TMV3                                       |

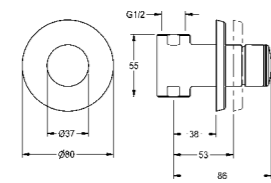

### F3S SELF-CLOSING STRAIGHT-WAY VALVE

F3S self-closing straight-way valve DN 15 for in-wall mounting with noise-reducing styrene cladding, for shower facilities. Hydraulically controlled, piston-free design, self-closing, stepless adjustment of flow duration. For connection to pre-mixed hot water or cold water. Changeable valve seat, with internal thread G 1/2, visible parts high-polished, chromium-plated brass. With rosette, depth adjustability 15mm. Dimensions: 80 x 80 x 86mm.

- |                               |                                 |
|-------------------------------|---------------------------------|
| <b>F3SV2003</b>               | Self-closing straight way valve |
| <b>Mandatory accessories:</b> |                                 |
| <b>AC17-047</b>               | TMV3                            |
| <b>SHAC0013</b>               | Aquajet - comfort showerhead    |
| OR                            |                                 |
| <b>AQUA751</b>                | Aquajet - slimline showerhead   |

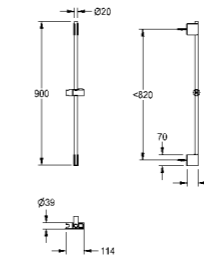

### SHOWER BRACKET

Chrome-plated brass shower slider bar with two wall-mounted brackets. Adjustable shower holder with pushbutton operation, made from chrome-plated plastic. Length 900mm, diameter 20mm, including mounting material.

- |                                   |                  |
|-----------------------------------|------------------|
| <b>ACXX2008</b>                   | Shower bracket   |
| <b>Complimentary accessories:</b> |                  |
| <b>26.000.111.040</b>             | Hand shower head |
| <b>26.001.003.000</b>             | Shower hose      |

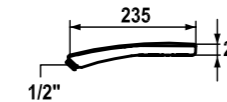

### HAND SHOWER

Hand shower, with TouchProtect, an anti-scald protection thanks to the "double skin" principle. Connecting thread 1/2". Designed with Easy Grip and colour contrast for the visually impaired.

Flow rate 12 l/min (3 bar)  
Dimensions: 22 x 235mm (W x D)

- |                                   |                  |
|-----------------------------------|------------------|
| <b>26.000.111.040</b>             | Hand shower head |
| <b>Complimentary accessories:</b> |                  |
| <b>26.001.003.000</b>             | Shower hose      |
| <b>ACXX2008</b>                   | Shower bracket   |

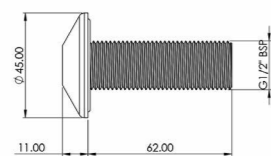
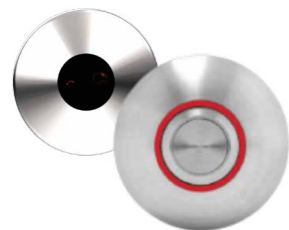

### 12V SHOWER TACTILE AND WAVE-ON SENSORS

Wave-on shower sensor manufactured from stainless steel complete with a 45mm bezel.

Complete with 15 metre cable  
Separate control box required  
Thread diameter: 1/2" BSP  
Dimensions: 45 x 45 x 73mm

- |                               |                                       |
|-------------------------------|---------------------------------------|
| <b>SH00-003</b>               | Wave-on sensor                        |
| OR                            |                                       |
| <b>AC02-050</b>               | Red tactile switch (hot) (wall mount) |
| <b>Mandatory accessories:</b> |                                       |
| <b>SH07-001</b>               | Shower Control System                 |

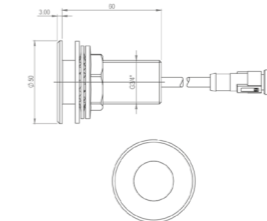
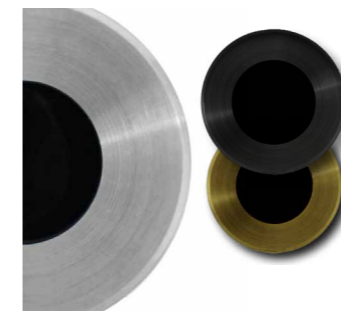

### KINGSWEAR STAINLESS STEEL PROGRAMMABLE SHOWER SENSOR

Wall Mounted Programmable Sensor is to be used in conjunction with the handheld programmer (AC01-001). The programmer will allow quick and easy adjustment of settings including; run-on time, range, purge and more. Real time data can be uploaded from the programmer via the USB port to allow accurate monitoring of water efficiency.

Station kit required  
External TMV3 required  
Dimensions: 50 x 50 x 60mm

- |                               |                             |
|-------------------------------|-----------------------------|
| <b>AC02-021</b>               | Programmable sensor         |
| <b>AT10-033</b>               | Programmable sensor - Black |
| <b>AT10-035</b>               | Programmable sensor - Gold  |
| <b>Mandatory accessories:</b> |                             |
| <b>AT00-221</b>               | Station kit                 |
| <b>AC17-047</b>               | TMV3                        |



# Versatile Elegance

## Reversible Stainless Steel Linear Drains

### Unmatched versatility, odour-free innovation

Introducing a cutting-edge solution that redefines shower drainage - the Stainless Steel Linear Drain with a Reversible Cover. This innovative design not only combines sleek aesthetics with seamless functionality but also offers a unique dual-purpose feature. Crafted with precision, this drain can be used as a tile insert, seamlessly integrating into your shower floor's design. Alternatively, it can be reversed to showcase the pristine stainless steel surface, adding a contemporary touch to your bathroom.

Equipped with an advanced odour eliminator, it ensures a consistently fresh and inviting atmosphere in your bathroom. Say goodbye to unpleasant odours that often accompany damp environments. The odour eliminator technology effectively neutralizes unwanted scents, guaranteeing a comfortable and hygienic experience for you and your guests.

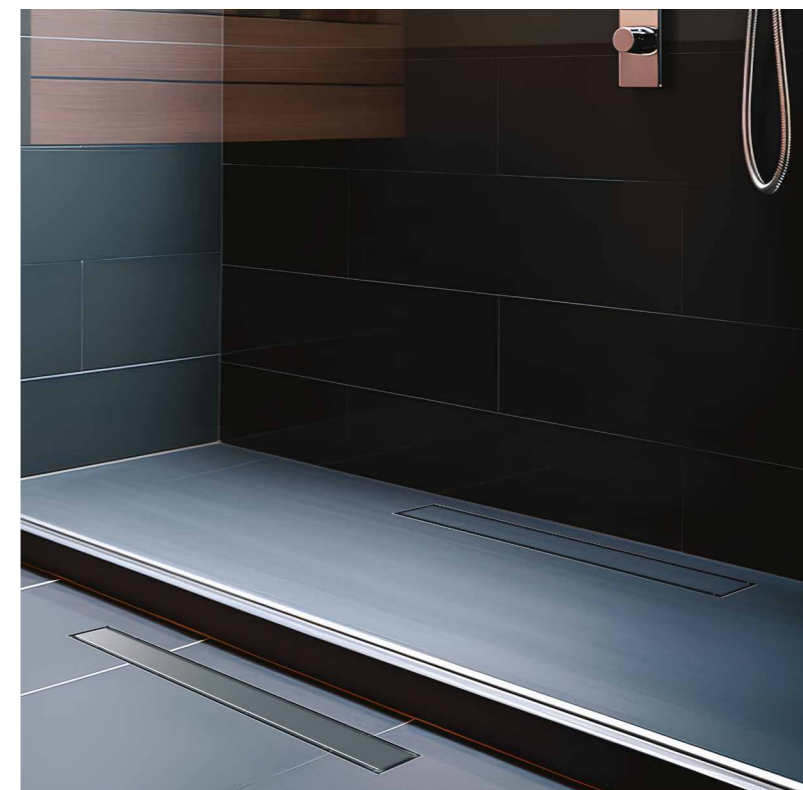

### Linear Shower Drain

LDOS302 / 2030073039

Dimensions: 300 x 90 x 70 (W x H x D)

\*Available in multiple widths of 600, 700, 800 and 900 mm



Reversible drain usage: Drain Cover is ingeniously designed to offer two distinct styles in one. Choose between the refined sophistication of a seamlessly integrated tile insert or the contemporary resilience of stainless steel, adapting effortlessly to your evolving preferences and interior designs.



Anti-blocking filter plate and odour prevention system with our all in one Linear Shower Drains.

(\*Contact sales person for any relevant customisation queries)





# Sleek Sophistication

## Square Drains for Modern Bathrooms

When it comes to transforming your bathroom into a modern oasis, square drains and tile insert drains provide the perfect balance of style and practicality. Square drains offer a contemporary and geometric aesthetic & tile insert drains take bathroom aesthetics to the next level by seamlessly integrating with your choice of tiles.

Both square drains and tile insert drains offer functional benefits beyond their aesthetic appeal. They prevent water buildup, reduce the risk of slips and falls, and contribute to maintaining a hygienic and comfortable bathroom environment. Additionally, their durable stainless steel construction ensures longevity and resistance to corrosion, making them suitable for daily use and exposure to moisture.

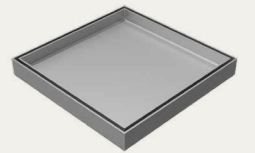

### Square Tile Insert Drain

**SD1304 / 2030067624**

- Satin finished tile insert drain, material thickness 2 mm, with 102 mmØ (4") outlet

Dimensions: 130 x 53 x 130 (W x H x D)

\* Available in multiple widths of 150 and 200 mm.

Variants

**SD1502 / 2030068810**

(With 51 mmØ (2") outlet)

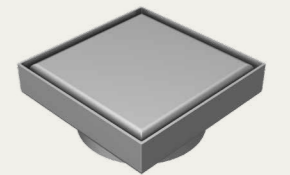

### Square Tile Drain with cover

**SD1304C / 2030067628**

- Satin finished square drain with stainless steel cover, material thickness 2 mm, with 102 mmØ (4") outlet

Dimensions: 130 x 53 x 130 (W x H x D)

\* Available in multiple widths of 150 and 200 mm.

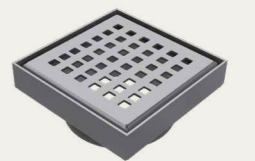

### Square Tile Drain with grated cover

**SD1304G / 2030071133**

- Satin finished square drain with stainless steel grated cover, material thickness 2 mm, with 102 mmØ (4") outlet

Dimensions: 130 x 53 x 130 (W x H x D)

\* Available in multiple widths of 150 and 200 mm.

(\*Contact sales person for any relevant customization queries)



## Accessible washrooms

Introducing our range of washrooms for disabled people: A thoughtfully designed collection for inclusive washroom facilities. This range is dedicated to enhancing accessibility and functionality for disabled people.

Key components include basins, Doc M packs, WCs, and grab rails. Basins offer ergonomic designs with ample knee clearance and easy reach. Doc M packs provide comprehensive solutions with harmonious combinations of grab rails, WCs, and basins.

Our WC and Doc M packs prioritise both comfort and function, featuring optimal seat heights and strategically positioned support bars. The discreetly designed grab rails offer stability and support whilst seamlessly blending into the washroom's aesthetics. More than just meeting standards, the KWC DVS accessible range aims to exceed expectations. It's a testament to our commitment to creating inviting and empowering spaces for everyone. Experience the transformation – where inclusivity meets elegance.

# Accessible sanitaryware

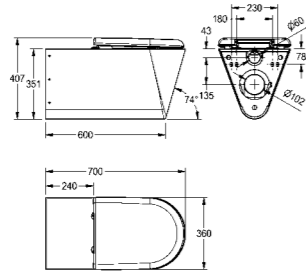

### CAMPUS ACCESSIBLE WALL HUNG WC

Wall hung accessible WC, stainless steel, surface satin finished, material thickness 1,5mm, flushing certificated to EN 997, concealed flushing rim with min. 4 litre flushing capacity, with a shrouded 100mm diameter horizontal 'P' trap outlet, pressed seat area tapered towards centre, all edges curved, fixing with included mounting plate conform to EN 33, includes safety screws.

Flush: 4 litre  
 Dimensions without toilet seat: 360 x 351 x 700mm  
 Dimensions with seat and lid: 360 x 407 x 700mm

- CMPX594** Without toilet seat
- CMPX594BN** With black seat and lid
- CMPX594GN** With grey seat and lid
- CMPX594WN** With white seat and lid
- Mandatory accessories:**
- AQFX0007** Installation frame, barrier-free

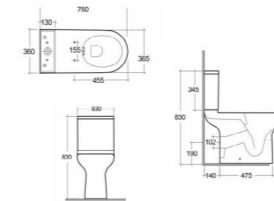

### CHARTHAM CLOSE COUPLED TOILET PAN WITH CISTERN

Rimless close coupled WC pan with extended projection to 750mm for Doc M compliance. Manufactured from high quality vitreous china to BS 3402. This close coupled toilet comes complete with the WC pan and close coupled 6/3ltr lever action cistern. With rimless design for optimum hygiene & ease of cleaning

4.5ltr effective flush volume  
 480mm high (including seat) and 750mm projection pan  
 Seat sold separately available in 3 colours (below)  
 Dimensions:

- SW00-088** Close coupled wc with cistern
- Mandatory accessories:**
- SW00-034** White toilet seat
- SW00-035** Blue toilet seat
- SW00-087** Dark grey toilet seat

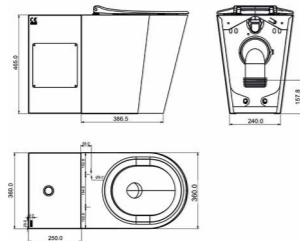

### CAMPUS STAINLESS STEEL ACCESSIBLE WC

Floor standing accessible WC pan, manufactured from grade 1.4301 (304) stainless steel with a satin polish finish, supplied complete with multikwik connector. A flush bend and 90° plastic bend are provided for the cistern downpipe connection. Rear mounting plate with 4 no. stainless steel bolts supplied, for mounting onto duct wall. The front of the WC is fixed to the floor using a joggle strip. Pipe fixing is achieved by using the side access panel provided. The WC is supplied with a disabled person's white plastic seat. Rear inlet and top inlet versions available. Cistern required.

Dimensions: 360 x 465 x 637mm

- G21748N** Accessible WC 480mm high - rear inlet
- G21748NT** Accessible WC 480mm high - top inlet

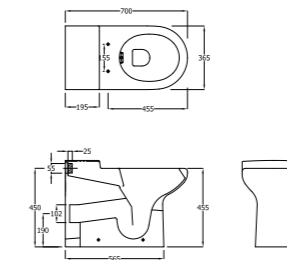

### CHARTHAM RIMLESS WC HBN COMPLIANT

Rimless back to wall WC pan with 700mm projection. Manufactured from high quality vitreous china to BS 3402. Designed with rimless flush to prevent bacteria from harbouring. Manufactured in accordance with HTM 64 / HBN 00-10, Part C Standards. Cistern required.

Dimensions: 365 x 455 x 700mm

- SW00-030** Chartham rimless WC HBN compliant
- Mandatory accessories:**
- SW00-034** White toilet seat
- SW00-035** Blue toilet seat
- SW00-087** Dark grey toilet seat

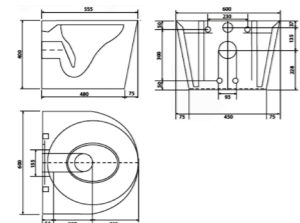

### CAMPUS BARIATRIC WC

The Bariatric toilet is manufactured from grade 1.4301 (304) stainless steel, material thickness 1.5mm - satin polish finish. Complies with BS EN997 for 4 litre flushing. The specially designed floor standing toilet is fitted with a seat that is ideal for making use more comfortable. Its large seat area gives increased support and comfort. A width of 50cm gives comfort, security and will give long lasting use in any hospital or medical installation and the increased width makes the toilet seat ideal for a larger person up to 1000kg. With heavy duty seat and lid - Max user weight 381kg. Cistern required.

Dimensions: 600 x 400 x 555mm

- G22080N** Campus bariatric WC

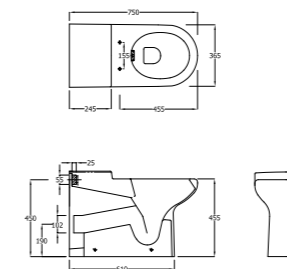

### CHARTHAM RIMLESS DOC M WC

Rimless back to wall WC pan with extended projection to 750mm for Doc M compliance. Manufactured from high quality vitreous china to BS 3402. Designed with rimless flush to prevent bacteria from harbouring. Cistern required.

Dimensions: 365 x 455 x 750

- SW00-031** Chartham rimless DOC M WC
- Mandatory accessories:**
- SW00-034** White toilet seat
- SW00-035** Blue toilet seat
- SW00-087** Dark grey toilet seat

# Accessible sanitaryware

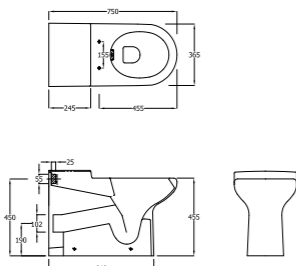

### WALL HUNG DOC M WC

Rimless back to wall WC pan with extended projection to 750mm for Doc M compliance. Manufactured from high quality vitreous china to BS 3402. Designed with rimless flush to prevent bacteria from harbouring. Cistern required.

Dimensions: 365 x 455 x 750

**SW00-089** Wall hung DOC M WC

**Mandatory accessories:**

**SW00-091** White seat for wall hung WC

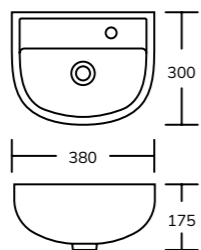

### WALL HUNG DOC M CERAMIC BASIN 380MM

San Ceram wall hung basin manufactured from Vitreous china with an alpine white finish. Designed with a right hand or left hand tap hole and is ideal where space is constraint. Complete without overflow and fixings for installation.

Doc M, HBN & HTM Compliant  
Dimensions: 380 x 175 x 300mm

**SW00-047** Basin with right hand tap hole

**SW00-048** Basin with left hand tap hole

**Mandatory accessories:**

**SW00-044** 1 1/4" Plastic bottle trap

**SW00-049** 1 1/4" Strainer waste - unslotted

OR

**SW00-050** 1 1/4" Press top waste - unslotted

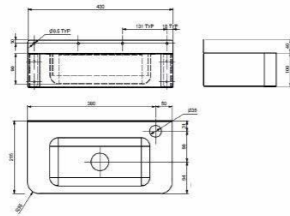

### STAINLESS STEEL ACCESSIBLE WASHBASIN

Stainless steel accessible washbasin for wall mounting. Manufactured from 1.4301 Chrome Nickel steel with a satin finish.

Dimensions 450 x 100 x 350mm  
Bowl dimensions 400 x 60 x 230mm

**ANMX150R** Stainless steel accessible washbasin RH

**ANMX150L** Stainless steel accessible washbasin LH

**Mandatory accessories:**

**SW00-044** 1 1/4" Plastic bottle trap

**SW00-049** 1 1/4" Strainer waste - unslotted

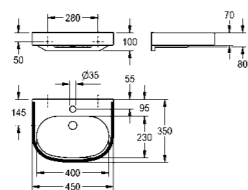

### VARIUSCARE SINGLE WASHBASIN, BARRIER-FREE

VARIUScare single wash basin made of MIRANIT resin-bonded mineral material. Colour Alpine white with colour strip. Wheelchair accessible, with integrated gripping edge. Seamless moulded bowl, without overflow. With tap hole. Mounting on washbasin back panel. Rear contoured edge. Mounting material included.

Dimensions 450 x 100 x 350mm  
Bowl dimensions 400 x 60 x 230mm

**ANMW505** Alpine White

**ANMW504-BLACK** Black strip (RAL 7022)

**ANMW504-BLUE** Blue strip (RAL 5011)

**ANMW504-RED** Red strip (RAL 3020)

**Mandatory accessories:**

**SW00-044** 1 1/4" Plastic bottle trap

**SW00-049** 1 1/4" Strainer waste - unslotted

OR

**SW00-050** 1 1/4" Press top waste - unslotted



## KWC DVS washrooms

### DOC M packs



#### CORNER WC DOC M PACK - BACK TO WALL BLUE

Blue Doc M back to wall pack supplied with: rimless 750mm projection back to wall WC with blue seat, concealed plastic cistern kit, WC Flushvalve kit with programmable sensor, 380mm single washbasin, slotted waste, bottle trap, Aquarius A45 doc M tap, anti-microbial single station mains kit, TMV3 thermostatic mixing valve, and grab rail kit.

Grab rail kit includes:

- 1 x backrest rail 400 x 150mm (RAL 5011)
- 1 x Blue backrest cushion (RAL 5011)
- 1 x double arm hinged support rail 760 x 250mm (RAL 5011)
- 4 x straight grab rail 35 x 600mm (RAL 5011)
- 1 x straight grab rail 35 x 450mm (RAL 5011)

**DMPX45LHB** Left hand  
**DMPX45RHB** Right hand



#### CORNER WC DOC M PACK - CLOSE COUPLED BLUE

Blue Doc M closed couple pack supplied with: Rimless 750mm projection closed coupled WC with blue seat, 380mm single washbasin, slotted waste, bottle trap, F5L-Therm barrier-free thermostatic single-lever pillar mixer tap, TMV3 thermostatic mixing valve, and grab rail kit.

Grab rail kit includes:

- 1 x double arm hinged support rail 760 x 250mm (RAL 5011)
- 4 x straight grab rail 35 x 600mm (RAL 5011)
- 1 x straight grab rail 35 x 450mm (RAL 5011)

**DMPXF5LHB** Left hand  
**DMPXF5RHB** Right hand



#### CORNER WC DOC M PACK - BACK TO WALL SATIN

Stainless steel Doc M back to wall pack supplied with: G21748N stainless steel floor standing accessible WC pan, cistern, flushvalve kit, Stainless steel barrier-free single washbasin, slotted waste, bottle trap, Aquarius A45 doc M tap, anti-microbial single station mains kit, TMV3 thermostatic mixing valve, and grab rail kit.

Grab rail kit includes:

- 1 x stainless steel backrest rail 400 x 150mm
- 1 x white backrest cushion
- 1 x stainless steel hinge support rail 760 x 250mm
- 4 x stainless steel straight grab rail 35 x 600mm
- 1 x stainless steel straight grab rail 35 x 450mm

**DMPX45LHS** Left hand  
**DMPX45RHS** Right hand



# DOC M packs with thermal disinfection and sight-line basin technology



## CORNER WC DOC M PACK - BTW WITH TDV

Blue Doc M back to wall pack supplied with: rimless 750mm projection back to wall WC with blue seat, concealed plastic cistern kit, WC Flushvalve kit with programmable sensor, Variuscare barrier-free single washbasin with blue coloured stripe for the visually impaired, slotted waste, bottle trap, Aquarius A45 doc M tap, anti-microbial single station mains kit, thermal disinfection valve, TMV3 thermostatic mixing valve, and grab rail kit.

Grab rail kit includes:

- 1 x backrest rail 400 x 150mm (RAL 5011)
- 1 x Blue backrest cushion (RAL 5011)
- 1 x double arm hinged support rail 760 x 250mm (RAL 5011)
- 4 x straight grab rail 35 x 600mm (RAL 5011)
- 1 x straight grab rail 35 x 450mm (RAL 5011)

**DMPX45LHBT** Left hand  
**DMPX45RHBT** Right hand



## CORNER WC DOC M PACK - CLOSE COUPLED WITH TDV

Blue Doc M closed couple pack supplied with: Rimless 750mm projection close coupled WC with blue seat, Variuscare barrier-free single washbasin with blue coloured stripe for the visually impaired, slotted waste, bottle trap, F5L-Therm barrier-free thermostatic single-lever pillar mixer tap, hygiene unit for F5L tap, battery compartment, TMV3 thermostatic mixing valve, and grab rail kit.

Grab rail kit includes:

- 1 x double arm hinged support rail 760 x 250mm (RAL 5011)
- 4 x straight grab rail 35 x 600mm (RAL 5011)
- 1 x straight grab rail 35 x 450mm (RAL 5011)

**DMPXF5LHBT** Left hand  
**DMPXF5RHBT** Right hand

**NEW** Hygiene unit allows thermal purge override of the manual tap



## CORNER WC DOC M PACK - BTW WITH TDV

Stainless steel Doc M back to wall pack supplied with: G21748N stainless steel floor standing accessible WC pan, cistern, flushvalve kit, Variuscare barrier-free single washbasin with black coloured stripe for the visually impaired, slotted waste, bottle trap, Aquarius A45 doc M tap, anti-microbial single station mains kit, thermal disinfection valve, TMV3 thermostatic mixing valve, and grab rail kit.

Grab rail kit includes:

- 1 x stainless steel backrest rail 400 x 150mm
- 1 x white backrest cushion
- 1 x stainless steel hinge support rail 760 x 250mm
- 4 x stainless steel straight grab rail 35 x 600mm
- 1 x stainless steel straight grab rail 35 x 450mm

**DMPX45LHST** Left hand  
**DMPX45RHST** Right hand



# Accessible shower DOC M packs



## DOC M SHOWER PACK CHROME

Stainless steel Doc M shower pack. Pack includes grab rail set, manufactured from stainless steel with 35mm diameter rails. Full doc M pack includes: Vita shower head, shower rail and hose, TMV3 thermostatic mixing valve and grab rail kit.

Grab rail kit includes:

- 1 x stainless steel backrest rail 400 x 150mm
- 1 x white backrest cushion
- 2 x stainless steel hinge support rail 760 x 250mm
- 2 x stainless steel straight grab rail 35 x 600mm
- 1 x stainless steel shower seat with white lid 650 x 400mm

**DMPXVT20S**



## DEMENTIA CARE DOC M SHOWER PACK WITH LIGATURE RESISTANT GRAB RAILS

Doc M shower pack in red supplied with: Vita pro lever mixer shower, shower rail and hose, thermal disinfection valve, TMV3 thermostatic mixing valve and grab rail kit.

Grab rail kit includes:

- 1 x ligature-resistant backrest rail 400 x 150mm (RAL 3020)
- 1 x ligature-resistant white backrest cushion
- 2 x ligature-resistant hinge support rail 760 x 250mm (RAL 3020)
- 2 x ligature-resistant straight grab rail 35 x 600mm (RAL 3020)
- 1 x shower seat 650mm (RAL 3020)

**DMPXVT20R**



## HIGH SECURITY LIGATURE RESISTANT DOC M SHOWER PACK

Doc M ligature resistant shower pack in blue supplied with: high security dual outlet shower, thermal disinfection valve, TMV3 thermostatic mixing valve and grab rail kit.

Grab rail kit includes:

- 1 x ligature-resistant backrest rail 400 x 150mm (RAL 5011)
- 1 x ligature-resistant white backrest cushion
- 2 x ligature-resistant hinge support rail 760 x 250mm (RAL 5011)
- 2 x ligature-resistant straight grab rail 35 x 600mm (RAL 5011)
- 1 x shower seat 650mm (RAL 5011)

**DMPXVR13B**



# Grab rail packs for back to wall WC



## BLUE BACK TO WALL GRAB RAIL PACK

### GRBX801

Grab rail kit includes:

<b>GRBX141B</b>	1 x straight grab rail 35 x 450mm
<b>GRBX161B</b>	4 x straight grab rail 35 x 600mm
<b>GRBX271B</b>	1 x double arm hinged support rail 760 x 250mm
<b>GRBX312B</b>	1 x Blue backrest cushion
<b>GRBX321B</b>	1 x backrest rail 400 x 150mm



## WHITE BACK TO WALL GRAB RAIL PACK

### GRBX805

Grab rail kit includes:

<b>GRBX141W</b>	1 x straight grab rail 35 x 450mm
<b>GRBX161W</b>	4 x straight grab rail 35 x 600mm
<b>GRBX271W</b>	1 x double arm hinged support rail 760 x 250mm
<b>GRBX312W</b>	1 x backrest cushion
<b>GRBX321W</b>	1 x backrest rail 400 x 150mm



## BLACK BACK TO WALL GRAB RAIL PACK

### GRBX810

Grab rail kit includes:

<b>GRBX141BLK</b>	1 x straight grab rail 35 x 450mm
<b>GRBX161BLK</b>	4 x straight grab rail 35 x 600mm
<b>GRBX271BLK</b>	1 x double arm hinged support rail 760 x 250mm
<b>GRBX312W</b>	1 x backrest cushion
<b>GRBX321BLK</b>	1 x backrest rail 400 x 150mm



## SATIN BACK TO WALL GRAB RAIL PACK

### GRBX812

Grab rail kit includes:

<b>GRBX141</b>	1 x straight grab rail 35 x 450mm
<b>GRBX161</b>	4 x straight grab rail 35 x 600mm
<b>GRBX271</b>	1 x double arm hinged support rail 760 x 250mm
<b>GRBX312W</b>	1 x backrest cushion
<b>GRBX321</b>	1 x backrest rail 400 x 150mm





KWC DVS washrooms

# Grab rail packs for close coupled WC



**BLUE GRAB RAIL PACK**

**GRBX802**

Grab rail kit includes:

**GRBX141B** 1 x straight grab rail 35 x 450mm

**GRBX161B** 4 x straight grab rail 35 x 600mm

**GRBX271B** 1 x hinged support rail 760 x 250mm



**WHITE GRAB RAIL PACK**

**GRBX806**

Grab rail kit includes:

**GRBX141W** 1 x straight grab rail 35 x 450mm

**GRBX161W** 4 x straight grab rail 35 x 600mm

**GRBX271W** 1 x hinged support rail 760 x 250mm



**BLACK GRAB RAIL PACK**

**GRBX811**

Grab rail kit includes:

**GRBX141BLK** 1 x straight grab rail 35 x 450mm

**GRBX161BLK** 4 x straight grab rail 35 x 600mm

**GRBX271BLK** 1 x hinged support rail 760 x 250mm



**SATIN GRAB RAIL PACK**

**GRBX813**

Grab rail kit includes:

**GRBX141** 1 x straight grab rail 35 x 450mm

**GRBX161** 4 x straight grab rail 35 x 600mm

**GRBX271** 1 x hinged support rail 760 x 250mm



# Accessible water controls

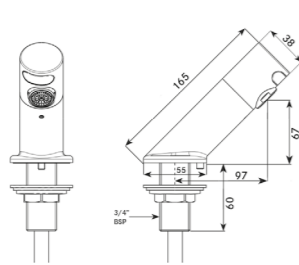

### AQUARIUS A45 DOC M TAP SPOUT

Aquarius deck mounted A45 Doc M tap manufactured in 316 stainless steel with a brushed finish. Sensor operated for maximum hygiene and efficiency. 5 litres per minute integrated flow control. (other flow rates available). Designed with automatic purge function, sensor range adjustment, wave on/wave off function, anti vandal and lock out functions and a chlorination function. TMV3 required. Spout projection: 97mm

- AT03-021 With PEX hose (15mm)
- AT03-022 With copper tails (10mm)
- Mandatory accessories:**
- AT00-221 Single station antimicrobial mains kit
- AC17-047 TMV3
- Complimentary accessories:**
- SD01-012 A45 soap dispenser

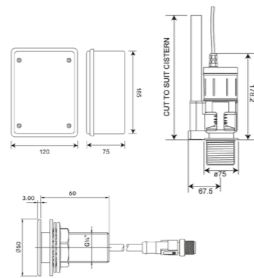

### PROGRAMMABLE SENSOR WC FLUSH VALVE KIT

Programmable sensor WC flush valve kit. Designed with WRAS approved 4 litre single flush and programmable sensor. Fits to new and existing WC cisterns.

- WC03-013 With 1 1/2" base - mains
- WC03-014 With 2" base - mains
- WC03-017 Mains - for use with AQFX frame
- WC03-052 With 1 1/2" base - battery
- WC03-053 With 2" base - battery
- WC03-019 Battery - for use with AQFX frame

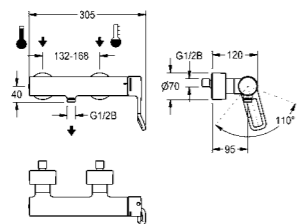

### F4LT-MED THERMOSTATIC SINGLE-LEVER SHOWER MIXER

F4LT-Med thermostatic lever mixer, thermostat-controlled mixer cartridge with expansion element & active scald protection, fail-safe against backflow as well as adjustable & turn-proof temperature stop, & ceramic disc technology. Optimised for cleaning, scald-protected, safe-touch housing with hand shower connection, G 1/2 B. All-metal construction, polished chromium-plated brass. Decoupled from the tap housing, volume-reduced, smooth water flow from low-lead brass (lead proportion  $\leq 0.2\%$ ), & without nickel coating. With thermal insulation components to reduce heat transfer from the tap housing to the cold-water line. Includes strainers & fully covered by depth-adjustable screw rosettes.

- F4LT2003 Shower mixer
- Mandatory accessories:**
- ACXX2008 Shower bracket
- 26.000.111.040 Hand shower head
- 26.001.003.000 Shower hose



# Accessible water controls

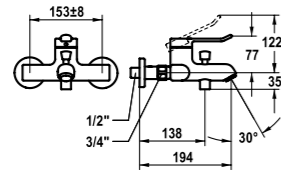

## VITA PRO 2.0 LEVER MIXER - BATH

Lever mixer tap, ensures precise water flow control. Inherently safe against backflow, its fixed spout incorporates Neoperl® Perlator® laminar tech for consistent water stream. The KWC cartridge with safety device M 35 OP, ceramic discs, and adjustable flow rate/temperature guarantee longevity and comfort. Easy installation with included 1/2" x 3/4" wall connections and shut-off valve L 40. Upgrade to a diverter that prioritizes safety, durability, and user experience.

**20.522.333.000** Vita pro 2.0 lever mixer - bath

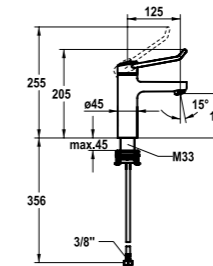

## VITA PRO 2.0 LEVER BASIN MIXER TAP

Discover unparalleled ease with our Diverter's intelligent design. The ergonomic polyamide lever ensures a secure grip, while the adjustable offset option enhances personalization. Embrace water efficiency with EcoProtect technology. Enjoy a fixed spout featuring Neoperl® Perlator® laminar flow. The KWC cartridge M 35 OP, with ceramic discs, offers variable flow/temperature, including a limit setting. Reinforced stopper ensures controlled output. Flexible 3/8" connection hoses, QuickInstallation via threaded connection, and ø35mm mounting hole simplify setup. Elevate your experience with a diverter that blends convenience and innovation seamlessly.

**12.528.051.000FL** Vita pro 2.0 lever basin mixer tap

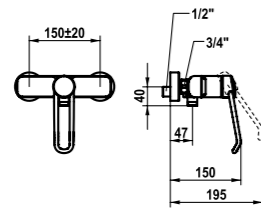

## VITA PRO 2.0 LEVER MIXER SHOWER

Iconic from every angle. A shower to meet the highest design standards. Timeless elegance in exceptional architecture. Operation designed for a secure grip, as well as safe and easy handling. Ergonomic and robust operating lever, made of polyamide to adjust the handling even better to suit personal requirements, the offset lever can be installed so that it is twisted into the cap (standard: see illustration). Inherently safe against backflow. KWC cartridge M 35 OP with ceramic discs flow rate and temperature continuously variable temperature limitation. Reinforced stopper for output volume and temperature (standard setting). Wall connections 1/2" x 3/4", without shut-off valve eccentric 10mm

**21.522.330.000** Vita pro 2.0 lever mixer shower

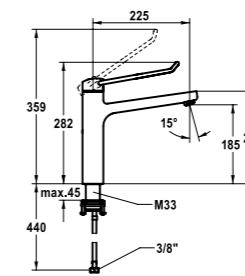

## VITA PRO 2.0 KITCHEN LEVER MIXER

Experience effortless and secure control with our Diverter's user-focused design. The ergonomic, robust polyamide operating lever ensures a comfortable grip, while the unique offset installation option caters to individual preferences. Enjoy a 150° swivel spout, Neoperl® Perlator® laminar flow, and ample OptimalSpace for all tasks. The KWC cartridge M 35 S, with ceramic discs, provides durability and adjustable flow/temperature, including temperature limitation. The diverter offers flexibility with 3/8" connection hoses, QuickInstallation via threaded connection, and ø35mm mounting hole. With a flow rate of 12 l/min (3 bar) and acoustic group I certification, it's the pinnacle of efficient, safe functionality.

**10.521.023.000LLFL** Vita pro 2.0 kitchen lever mixer

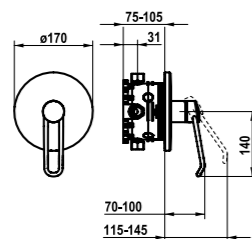

## VITA PRO 2.0 LEVER MIXER SHOWER

Experience unparalleled control with our Diverter, meticulously crafted for secure and effortless operation. Its ergonomic polyamide lever ensures a reliable grip, and the offset option adapts to individual preferences. Choose top or below outflow placements. The KWC cartridge M 35 H, featuring ceramic discs, allows continuous flow and temperature adjustments. Included in the package are the function unit, lever, cap, sleeve, cover plate, and holder for the escutcheon. Fasten the cover plate without screws for a streamlined look. For concealed installation, consider the separately available KWC BLUEBOX® unit. Enhance your space with a diverter that combines functionality and convenience seamlessly.

**21.524.500.000** Vita pro 2.0 lever mixer shower  
**39.999.900.931** Blue box without shut-off valve  
**39.999.910.931** Blue box with shut-off valve

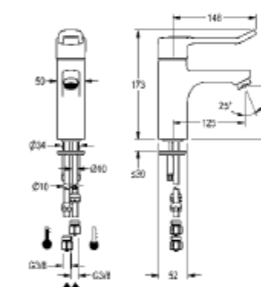

## F5L-THERM THERMOSTATIC SINGLE-LEVER PILLAR MIXER

Single-lever mixer with thermal disinfection capability. DN 15 pillar mixer for accessible sanitary facilities, lever length 150mm. Designed with Easy grip and colour contrast for the visually impaired. Thermostatically-controlled mixer cartridge with expansion element and active scald protection as well as adjustable and turn-proof temperature stop, and ceramic disc technology. With mechanism for optional hygiene unit for automatic hygiene flushing and program-controlled thermal disinfection and storage of statistical data. Lever cap in ergonomic bracket design, with slight curvature in the front and basalt-grey coating, in line with two-senses principle (tactile and visual). For connection to hot water and cold water via pipes, includes strainers.

**F5LT1011** F5L Tap  
**Complimentary accessories:**  
**ACLX1001** Hygiene unit for on-wall installation  
**ACLX1005** Hygiene unit for in-wall installation  
**SD01-003** Pillar soap dispenser (chrome)



## Nursery Washrooms

Transform your nursery washrooms into a vibrant and all-inclusive space that promotes healthy hygiene habits that last a lifetime. Our Washino, F3 and Flushino ranges can be combined to create a fun and engaging environment where children can learn, play, and stay clean. From colourful designs to innovative features, our washroom range has everything you need to create a safe, inspiring, and hygienic space for your little ones.

# Colourful & Inclusive Washrooms

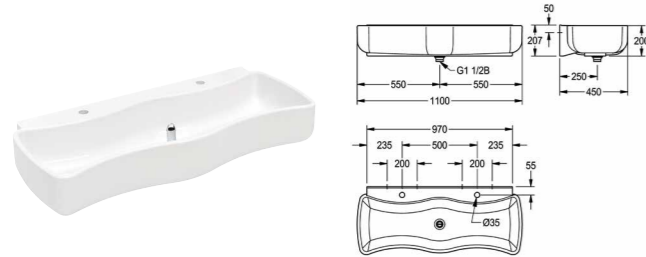

### WASHINO 2/3 CHILDREN'S WASH AND PLAY TROUGH

WASHINO children's wash-and-play trough made of MIRANIT resin-bonded mineral material, Alpine white colour. With options for 2 or 3 wash places. Wave-shaped basin, large inner and outer radii of basins, with integrated surge edge, tap landing with a tap hole for each wash place. Mounting on washbasin back panel. Mounting material included.

Complete with stand pipe overflow waste

<b>SANW200P</b>	2 tap holes	1100 x 450 x 207mm
<b>SANW215P</b>	3 tap holes	1600 x 450 x 207mm

**Complimentary accessories:**

<b>MT00-050</b>	AQUAPINO nursery tap
<b>F3SV1101</b>	F3 Self closing tap for pre-mixed
<b>F3SV1004</b>	F3 self closing tap for pre-mixed anti-block

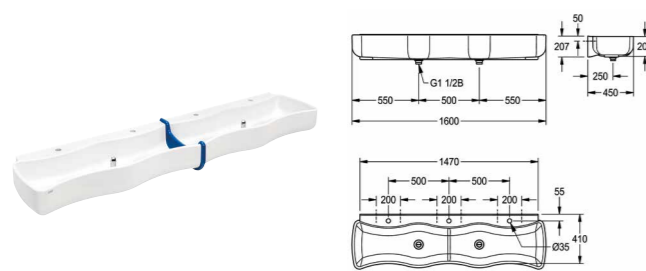

### WASHINO 4 CHILDREN'S WASH AND PLAY TROUGH

WASHINO-4 children's wash-and-play trough made of MIRANIT resin-bonded mineral material, Alpine white colour. With 4 wash places. Wave-shaped basins, large inner and outer radii of basins, with integrated surge edge, tap landing with a tap hole for each wash place. Integrated divider with overflow function made of MIRANIT, blue colour (RAL 5002). Waste and overflow valve as a standpipe for 2 wash places each. Each basin with one waste outlet (distance between the outlets 1000mm). Mounting on washbasin back panel. Mounting material included.

Dimensions 2100 x 240 x 470mm

**SANW205P** Wash and play trough

**Complimentary accessories:**

<b>MT00-050</b>	AQUAPINO nursery tap
<b>F3SV1101</b>	F3 Self closing tap for pre-mixed
<b>F3SV1004</b>	F3 self closing tap for pre-mixed anti-block

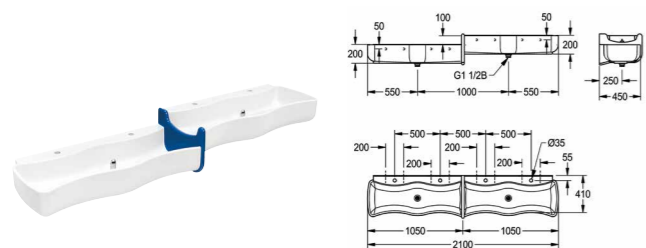

### WASHINO-STEP CHILDREN'S WASH AND PLAY TROUGH

WASHINO-Step children's wash-and-play trough made of MIRANIT resin-bonded mineral material, Alpine white colour. Model with basin right top/left bottom. With 4 wash places (2 wash places with a height difference of 100mm). Wave-shaped basins, large inner and outer radii of basins, with integrated surge edge, tap landing with a tap hole for each wash place. Integrated divider with overflow function made of MIRANIT, blue colour (RAL 5002). Waste and overflow valve as a standpipe for 2 wash places each. Each basin with one waste outlet (distance between the outlets 1000mm). Mounting on washbasin back panel. Mounting material included.

Dimensions 2100 x 340 x 470mm

**SANW212P** Split level right high, left low

**SANW211P** Split level left high, right low

**Complimentary accessories:**

<b>MT00-050</b>	AQUAPINO nursery tap
<b>F3SV1101</b>	F3 Self closing tap for pre-mixed
<b>F3SV1004</b>	F3 self closing tap for pre-mixed anti-block

# NEW Aquapino Nursery Tap

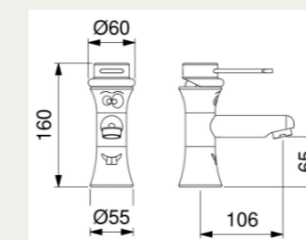

### AQUAPINO NURSERY TAP FOR PRE-MIXED SUPPLY

Introducing the Aquapino Pillar mixer tap that has been specially designed to cater to the handwashing needs of nurseries. This tap comes equipped with an advanced Eco-stop cartridge that enables water conservation, making it an eco-friendly choice. The tap has a flow limiter of 6 l/min for an optimal flow rate. Additionally, the tap has been coated with a non-toxic material that ensures the safety of the children using it. The Aquapino Pillar mixer tap is the perfect choice for any nursery setting.

**MT00-050** AQUAPINO nursery tap

**Mandatory accessories:**

**AC17-047** TMV3

# Flushino Nursery WCs

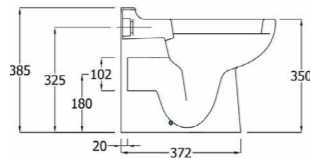

## FLUSHINO BACK TO WALL WC

Our Flushino Back to Wall toilet pan is the ideal height for young children at 350mm, to encourage and support hygienic, independent use. Manufactured from high quality vitreous china to BS 3402. When paired with Washino & Aquapino, the Flushino completes your ultimate nursery washroom solution.

Meets BS EN997:2018

**SW00-120** Childrens height WC

**Mandatory accessories:**

**FLSY0003** Aquafix cistern kit 1 1/2"

**SW00-121** Flushino toilet seat - White

**Choose from the Flushino plates on the opposite page**

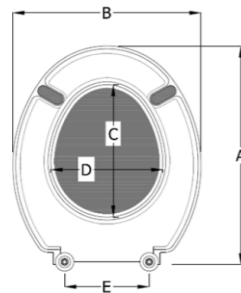

## FLUSHINO TOILET SEAT

Flushino range toilet seat for use with our back to wall pan. Made from robust and hygienic ABS plastic. Includes chromed brass hinges.

**SW00-121** Flushino toilet seat - White

**Mandatory accessories:**

**SW00-120** Childrens height WC

**FLSY0003** Aquafix cistern kit 1 1/2"

**Choose from the Flushino plates on the opposite page**

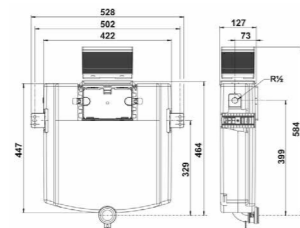

## AQUAFIX INSULATED CONCEALED CISTERN KIT

AQUAFIX Concealed cistern with front access, height: 820 mm, insulated against condensation, with dual flush (6l/3l), button function transmitted to AQUAFIX flush valve via flexible cables, connection to push plate via turn-click connection, flush pipe bend with protection cap, AQUAFIX fill valve Noise Class I, angle valve R 1/2, protection box for access opening can be cut to size, with fixing brackets, without fastenings, packed in a box concealed cistern tested to DIN EN 14055, Noise Class I

**FLSY0003** Aquafix cistern kit 1 1/2"

**Choose from the Flushino plates on the opposite page**

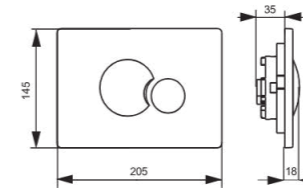
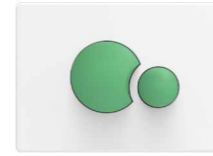

## FLUSHINO NURSERY PUSH PLATE - GREEN

Nursery Push plate - RAL 6032  
Push plate for nursery & schools  
l/w/h: 205/145/18 mm, plastic, for AQUAFIX concealed cisterns with front access, dual flush, consisting of actuator frame, push buttons, support bracket and fixing bolts, packed in a box

**AQUA561** Nursery push plate - Green

**Mandatory accessories:**

**FLSY0003** Aquafix cistern kit 1 1/2"

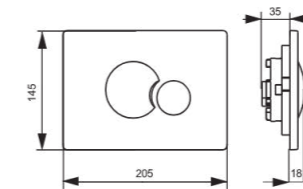
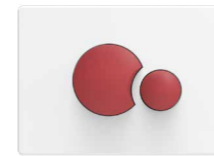

## FLUSHINO NURSERY PUSH PLATE - RED

Nursery Push plate - RAL 3003  
Push plate for nursery & schools  
l/w/h: 205/145/18 mm, plastic, for AQUAFIX concealed cisterns with front access, dual flush, consisting of actuator frame, push buttons, support bracket and fixing bolts, packed in a box

**AQUA559** Nursery push plate - Red

**Mandatory accessories:**

**FLSY0003** Aquafix cistern kit 1 1/2"

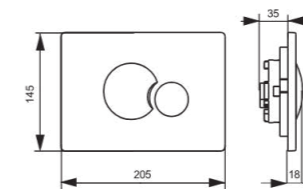

## FLUSHINO NURSERY PUSH PLATE - BLUE

Nursery Push plate - RAL 5002  
Push plate for nursery & schools  
l/w/h: 205/145/18 mm, plastic, for AQUAFIX concealed cisterns with front access, dual flush, consisting of actuator frame, push buttons, support bracket and fixing bolts, packed in a box

**AQUA558** Nursery push plate - Blue

**Mandatory accessories:**

**FLSY0003** Aquafix cistern kit 1 1/2"

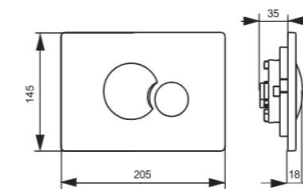
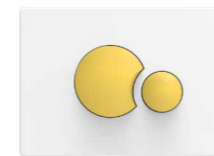

## FLUSHINO NURSERY PUSH PLATE - YELLOW

Nursery Push plate - RAL 1023  
Push plate for nursery & schools  
l/w/h: 205/145/18 mm, plastic, for AQUAFIX concealed cisterns with front access, dual flush, consisting of actuator frame, push buttons, support bracket and fixing bolts, packed in a box

**AQUA560** Nursery push plate - Yellow

**Mandatory accessories:**

**FLSY0003** Aquafix cistern kit 1 1/2"



## Baby change

The range of Cambrino baby changing tables are suitable for all public and semi-public premises including restaurants, hotels, airports, office buildings, public spaces and many more. The wall mounted units have been beautifully designed and manufactured from bacterial resistant polypropylene with an option for a stainless steel front cover to suit all modern washroom designs.

The range consists of two different materials; solid surface and polypropylene with antibacterial Biocote. The polypropylene range includes horizontal and vertical changing tables and the option to include a stainless steel front cover. These fully compliant baby changing tables can enhance any washroom and provide a hygienic, practical and safe solution.

# Baby change units

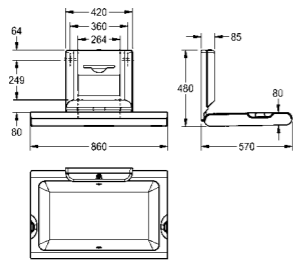

### CAMBRINO HORIZONTAL BABY CHANGING TABLE

CAMBRINO horizontal baby changing table for wall mounting, made of polypropylene with antibacterial Biocote® protection, white colour, hinged, with integrated shock absorber for safe opening and closing, nylon safety belt and hooks on both sides, lockable dispenser for single-use paper covers in Interfold folding with maximum width 260mm. Certified according to EN 12221-1 and EN 12221-2. Including mounting material and 80 single-use paper covers.

Dimensions when closed 860 x 565 x 100mm (W x H x D)  
Dimensions when open 860 x 480 x 570mm (W x H x D)

**CAMB10HP** Horizontal changing table - plastic

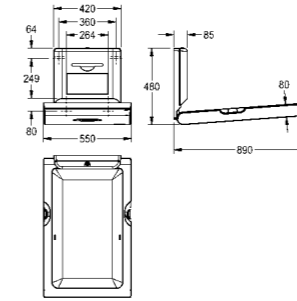

### CAMBRINO VERTICAL BABY CHANGING TABLE

CAMBRINO vertical baby changing table for wall mounting, made of polypropylene with antibacterial Biocote® protection, white colour, hinged, with integrated shock absorber for safe opening and closing, nylon safety belt and hooks on both sides, lockable dispenser for single-use paper covers in Interfold folding with maximum width 260mm. Certified according to EN 12221-1 and EN 12221-2. Including mounting material and 80 single-use paper covers.

Dimensions when closed 550 x 890 x 100mm (W x H x D)  
Dimensions when open 550 x 480 x 890mm (W x H x D)

**CAMB20VP** Vertical changing table - plastic

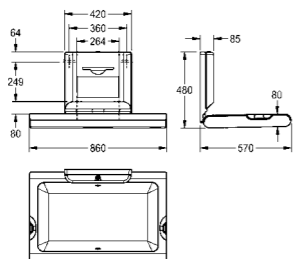

### CAMBRINO HORIZONTAL BABY CHANGING TABLE WITH STAINLESS STEEL COVER

CAMBRINO horizontal baby changing table for wall mounting, made of polypropylene with antibacterial Biocote® protection, white colour, front panel made of stainless steel, hinged, with integrated shock absorber for safe opening and closing, nylon safety belt and hooks on both sides, lockable dispenser for single-use paper covers in Interfold folding with maximum width 260mm. Certified according to EN 12221-1 and EN 12221-2. Including mounting material and 80 single-use paper covers.

Dimensions when closed 860 x 565 x 100mm (W x H x D)  
Dimensions when open 860 x 480 x 570mm (W x H x D)

**CAMB11HS** Horizontal changing table - s/steel

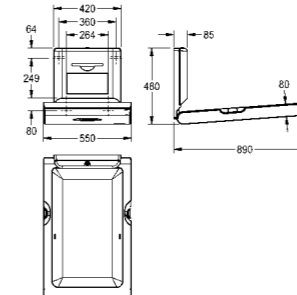

### CAMBRINO VERTICAL BABY CHANGING TABLE WITH STAINLESS STEEL COVER

CAMBRINO vertical baby changing table for wall mounting, made of polypropylene with antibacterial Biocote® protection, white colour, front panel made of stainless steel, hinged, with integrated shock absorber for safe opening and closing, nylon safety belt and hooks on both sides, lockable dispenser for single-use paper covers in Interfold folding with maximum width 260mm. Certified according to EN 12221-1 and EN 12221-2. Including mounting material and 80 single-use paper covers.

Dimensions when closed 550 x 890 x 100mm (W x H x D)  
Dimensions when open 550 x 480 x 890mm (W x H x D)

**CAMB22VS** Vertical changing table - s/steel

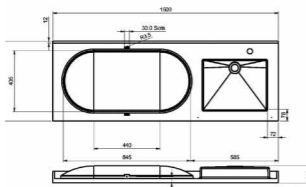

### CAMBRINO SOLID SURFACE BABY CHANGE 1.5 METRE

Cambrino solid surface baby changing unit for wall mounting. Manufactured from MIRANIT resin-bonded mineral material, with smooth, pore-free surface (temperature-resistant up to 80 °C). Colour Alpine white. With seamless. Left and right hand versions available.

Dimensions: 1500 x 114 x 530mm

**ANMW0029** Left hand change right hand bowl

**ANMW0025** Right hand change left hand bowl

**Complimentary accessories:**

**AT03-011** Aquarius A45 tap

**AT00-220** Single station kit

**AC17-047** TMV3

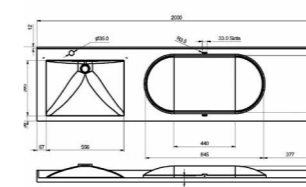

### CAMBRINO SOLID SURFACE BABY CHANGE 2 METRE

Cambrino solid surface baby changing unit for wall mounting. Manufactured from MIRANIT resin-bonded mineral material, with smooth, pore-free surface (temperature-resistant up to 80 °C). Colour Alpine white. With seamless. Left and right hand versions available.

Dimensions: 2000 x 114 x 530mm

**ANMW0028** Left hand change right hand bowl

**ANMW0024** Right hand change left hand bowl

**Complimentary accessories:**

**AT03-011** Aquarius A45 tap

**AT00-220** Single station kit

**AC17-047** TMV3





## Accessories

Elevate any washroom to a new level of sophistication with the KWC DVS range of stainless steel and PVD coated washroom accessories. Breaking free from tradition, KWC DVS offers multiple accessory ranges to enhance your washroom. Catering to both classic and contemporary environments, these accessories suit various specifications and budgets, adding a touch of distinction.

Our stainless steel and PVD coated accessories don't just complement washrooms; they redefine them. Embrace innovation in form and function as you create an ambiance that transcends the ordinary. Whether you're looking to enhance the elegance of a classic setting or infuse a modern space with character, KWC DVS accessories are designed to meet your unique vision.

# Premium, high capacity, automatic soap dispensers

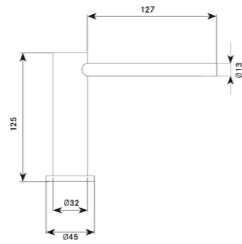

## PILLAR SOAP DISPENSER - CHROME

Pillar soap dispenser, manufactured from brass with a chrome finish. Designed with a touch-free operation and minimalistic easy to clean designed. These dispensers are suitable for a wide range of environments including; hospitals, airports, motorway services, food preparation facilities, supermarkets and more. Includes mains PSU & battery unit (batteries not included).

Mains PSU and battery unit can also be used simultaneously in order to enable battery back up feature.

Spout projection: 127mm  
Soap bottle capacity: 1.8 litres

**SD01-003** Pillar soap dispenser - Chrome

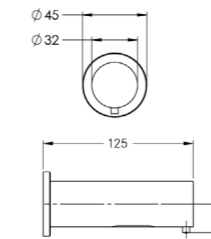

## WALL MOUNTED SOAP DISPENSER - CHROME

Wall mounted soap dispenser, manufactured from brass with a chrome finish. Designed with a touch-free operation and minimalistic easy to clean designed. These dispensers are suitable for a wide range of environments including; hospitals, airports, motorway services, food preparation facilities, supermarkets and more. Includes mains PSU & battery unit (batteries not included).

Mains PSU and battery unit can also be used simultaneously in order to enable battery back up feature.

Spout projection: 125mm  
Soap bottle capacity: 1.8 litres

**SD01-001** Wall mounted soap dispenser - Chrome

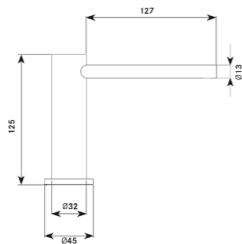

## PILLAR SOAP DISPENSER - BRUSHED

Pillar soap dispenser, manufactured from brass with a brushed nickel finish. Designed with a touch-free operation and minimalistic easy to clean designed. These dispensers are suitable for a wide range of environments including; hospitals, airports, motorway services, food preparation facilities, supermarkets and more. Includes mains PSU & battery unit (batteries not included).

Mains PSU and battery unit can also be used simultaneously in order to enable battery back up feature.

Spout projection: 127mm  
Soap bottle capacity: 1.8 litres

**SD01-008** Pillar soap dispenser - Brushed

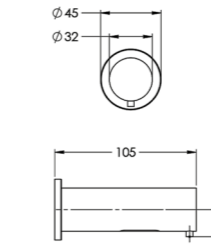

## WALL MOUNTED SOAP DISPENSER - BRUSHED

Wall mounted soap dispenser, manufactured from brass with a brushed nickel finish. Designed with a touch-free operation and minimalistic easy to clean designed. These dispensers are suitable for a wide range of environments including; hospitals, airports, motorway services, food preparation facilities, supermarkets and more. Includes mains PSU & battery unit (batteries not included).

Mains PSU and battery unit can also be used simultaneously in order to enable battery back up feature.

Spout projection: 105mm  
Soap bottle capacity: 1.8 litres

**SD01-005** Wall mounted soap dispenser - Brushed

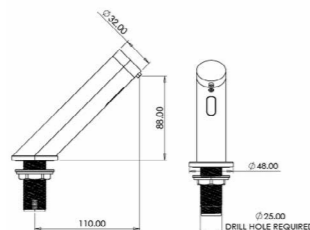

## DECK MOUNTED SOAP DISPENSER - BRUSHED

Deck mounted A45 soap dispenser, manufactured from brass. Touch-free operation and minimalistic easy to clean design. Available in either a chrome or brushed finish, these dispensers are suitable for a wide range of environments including; hospitals, airports, motorway services, food preparation facilities, supermarkets and more. Includes mains PSU & battery unit (batteries not included).

Mains PSU and battery unit can also be used simultaneously in order to enable battery back up feature.

Spout projection: 127mm  
Soap bottle capacity: 1.8 litres

**SD01-012** Nickel brush finish

**SD01-013** Chrome finish

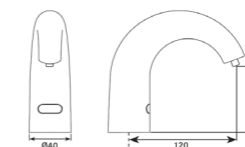

## SWAN SOAP DISPENSER - CHROME

Deck mounted Swan soap dispenser, manufactured from brass. Touch-free operation and minimalistic easy to clean design. Available in either a chrome or brushed finish, these dispensers are suitable for a wide range of environments including; hospitals, airports, motorway services, food preparation facilities, supermarkets and more. Includes mains PSU & battery unit (batteries not included).

Mains PSU and battery unit can also be used simultaneously in order to enable battery back up feature.

Spout projection: 120mm  
Soap bottle capacity: 1.8 litres

**SD01-002** Swan soap dispenser - Chrome

# Automatic Soap Dispensers

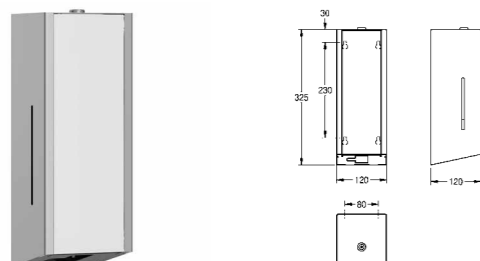

## EXOS. ELECTRONIC SOAP DISPENSER - WHITE

Touch free soap dispenser for wall mounting, stainless steel with satin finish, front and casing with InoxPlus surface refinement for the reduction of finger marks and better cleaning characteristics (easy to clean), material thickness 1.2mm, inspection window on side, infrared sensor activity for non-touch operation, LED display shows battery status, requires 4 pieces 1.5 V AA batteries, suitable for liquid soap and lotions, includes 800 ml refill tank, dispenses 0.6 - 1.1 ml depending on soap, includes mounting materials.

Dimensions 120 x 325 x 120mm (W x H x D)

**EXOS625W** White toughened safety glass front

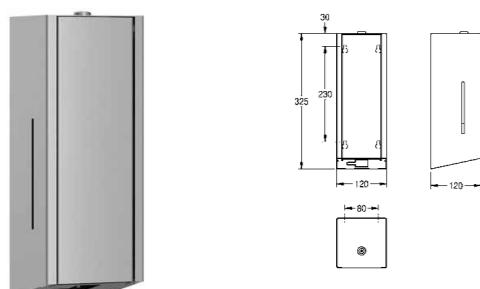

## EXOS. ELECTRONIC SOAP DISPENSER - STEEL

Touch free soap dispenser for wall mounting, stainless steel with satin finish, front and casing with InoxPlus surface refinement for the reduction of finger marks and better cleaning characteristics (easy to clean), material thickness 1.2mm, inspection window on side, infrared sensor activity for non-touch operation, LED display shows battery status, requires 4 pieces 1.5 V AA batteries, suitable for liquid soap and lotions, includes 800 ml refill tank, dispenses 0.6 - 1.1 ml depending on soap, includes mounting materials.

Dimensions 120 x 325 x 120mm (W x H x D)

**EXOS625X** Stainless steel front

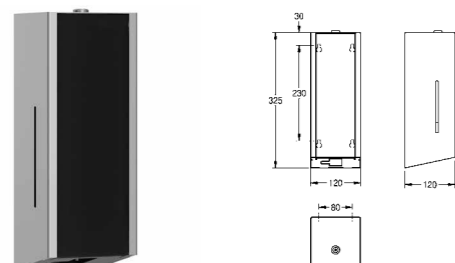

## EXOS. ELECTRONIC SOAP DISPENSER - BLACK

Touch free soap dispenser for wall mounting, stainless steel with satin finish, front and casing with InoxPlus surface refinement for the reduction of finger marks and better cleaning characteristics (easy to clean), material thickness 1.2mm, inspection window on side, infrared sensor activity for non-touch operation, LED display shows battery status, requires 4 pieces 1.5 V AA batteries, suitable for liquid soap and lotions, includes 800 ml refill tank, dispenses 0.6 - 1.1 ml depending on soap, includes mounting materials.

Dimensions 120 x 325 x 120mm (W x H x D)

**EXOS625B** Black toughened safety glass front

A splash of colour

# NEW The Dartmouth Soap Dispensers



**AC17-030** Dartmouth SD Satin



**AT10-081** Dartmouth SD Gold



**AT10-080** Dartmouth SD Black

Introducing the elegant and functional Dartmouth Touch-Free Soap Dispenser - the perfect addition to your washroom. This dispenser is made of high-quality 304 stainless steel and is available in a beautiful satin finish or an extremely durable PVD coating in a variety of colours. The wall-mounted casing is designed to be vandal-resistant, ensuring that your dispenser looks its best for longer. It also comes with a battery-low LED indicator, giving you peace of mind that the dispenser will always be ready to use. The touch-free operation feature helps to reduce cross-contamination and improves washroom hygiene - making it perfect for any public washroom.

Pair it with the Kingswear and Brixham ranges for an ultimate washroom solution where style is given the highest priority. With the Dartmouth Touch-Free Soap Dispenser, you can add a splash of colour and style to your washroom while maintaining the highest level of hygiene.

Sensor detection range: 5cm (approx)  
Dimensions: 110 x 268 x 107mm

# Soap Dispensers

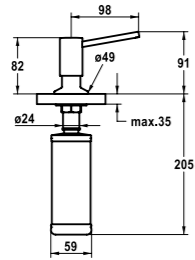

### KWC BASIC SOAP DISPENSER - CHROME

KWC basic soap dispenser. Easily refillable from top without disassembly. Designed to be deck mounted with mounting hole size  $\varnothing 26$ mm. Supplied with soap pump and container with filling capacity of 320ml.

Dimensions: 49 x 82 x 98mm

**Z.538.409.000** Chrome

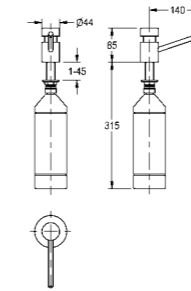

### KWC BASIC SOAP DISPENSER - STEEL

KWC basic soap dispenser. Easily refillable from top without disassembly. Designed to be deck mounted with mounting hole size  $\varnothing 26$ mm. Supplied with soap pump and container with filling capacity of 320ml.

Dimensions: 49 x 82 x 98mm

**Z.538.409.177** Brushed steel

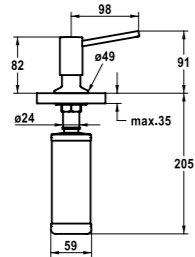

### KWC BASIC SOAP DISPENSER - BLACK

KWC basic soap dispenser. Easily refillable from top without disassembly. Designed to be deck mounted with mounting hole size  $\varnothing 26$ mm. Supplied with soap pump and container with filling capacity of 320ml.

Dimensions: 49 x 82 x 98mm

**Z.538.409.176** Matte black

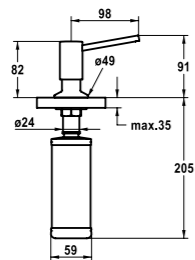

### DECK MOUNTED SOAP DISPENSER

Soap dispenser for table top mounting into worktops with max. 45mm thickness, high polished chromated brass, requires 22mm drilling hole, 1/2" thread, spout not movable, spout length 140mm, suitable for liquid soaps and lotions, 1 liter soap tank with membrane for pressure balance, filled from above.

With standard body length (85mm)

Dimensions: 44 x 400 x 162mm

**SD80** Deck mounted soap dispenser

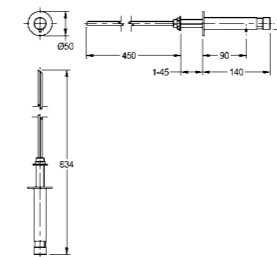

### WALL MOUNTED SOAP DISPENSER

Soap dispenser for wall mounting and re-filling from Serviceroom behind the wall, high polished chromated brass, requires 18mm drilling hole, 3/8" thread, spout not movable, suitable for liquid soaps and lotions, without soap tank (can be directly connected to soap can), for filling from behind the wall.

Dimensions 50 x 50 x 634mm

**SD110** Wall mounted soap dispenser

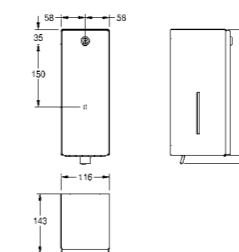

### RODAN SOAP DISPENSER

Soap dispenser for wall mounting, stainless steel, surface satin finished, material thickness 0.8mm, folded front cover, cylinder lock with KWC standard key, suitable for liquid soaps and lotions, 0.8 liter soap tank, lever to pull, includes stainless steel screws and dowels.

**RODX618** Manual 116 x 321 x 143mm

**RODX625** Sensor 120 x 296 x 107mm

# Soap Dispensers

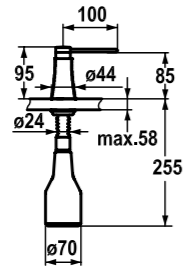

### KWC ZOE SOAP DISPENSER

KWC Zoe soap dispenser, manufactured with either a chrome or steel finish. Designed to be easily refilled from the top without requiring disassembly. It features a mounting hole with a diameter of 26mm. The package includes the pump and a soap container with a filling capacity of 350 ml, identified as Z.635.713. If needed, the Z.536.291.000 or Z.536.292.700, can be ordered separately as optional components.

Dimensions: 44 x 95 x 100mm

Z.536.586.000 Chrome finish  
Z.536.586.127 Steel finish

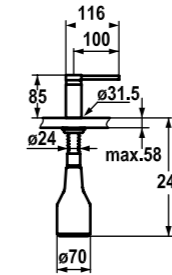

### KWC AVA SOAP DISPENSER - CHROME

KWC Ava soap dispenser with a chrome finish. Designed to allow convenient top refilling without the need for disassembly. It features a mounting hole with a diameter of 26mm for easy installation. The package includes a pump and a soap container with a filling capacity of 350 ml, identified as Z.635.713.

Dimensions: 31.5 x 85 x 116mm

Z.536.159.000

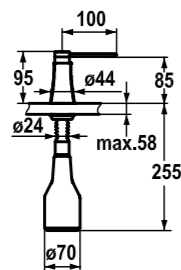

### KWC ZOE SOAP DISPENSER - WHITE

KWC Zoe soap dispenser, manufactured with a white finish. Designed for effortless refilling from the top, eliminating the need for any disassembly. It is equipped with a mounting hole that has a diameter of 26mm for easy installation. The package includes a pump and a soap container with a generous capacity of 350 ml, identified as Z.635.713. If needed, the Z.536.291.000 or Z.536.292.700, can be ordered separately as optional components.

Dimensions: 44 x 95 x 100mm

Z.536.586.150

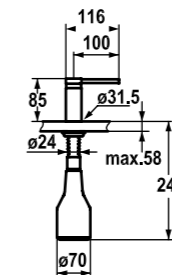

### KWC AVA SOAP DISPENSER - STEEL

KWC Ava soap dispenser with steel finish. Designed to allow convenient top refilling without the need for disassembly. It features a mounting hole with a diameter of 26mm for easy installation. The package includes a pump and a soap container with a filling capacity of 350 ml, identified as Z.635.713.

Dimensions: 31.5 x 85 x 116mm

Z.536.159.127

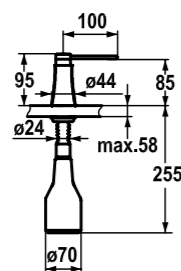

### KWC ZOE SOAP DISPENSER - BLACK

KWC Zoe soap dispenser, manufactured with a matte black finish. Designed for convenient top-refilling without the need for disassembly. It has a mounting hole diameter of 26mm. The package includes a pump and a soap container with a capacity to hold 350 ml, identified as Z.635.713.

Dimensions: 44 x 95 x 100mm

Z.536.586.176

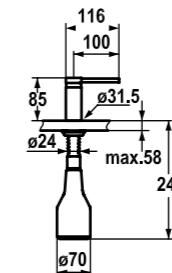

### KWC AVA SOAP DISPENSER - BLACK

KWC Ava soap dispenser with black finish. Designed to allow convenient top refilling without the need for disassembly. It features a mounting hole with a diameter of 26mm for easy installation. The package includes a pump and a soap container with a filling capacity of 350 ml, identified as Z.635.713.

Dimensions: 31.5 x 85 x 116mm

Z.536.159.176

# Waste management

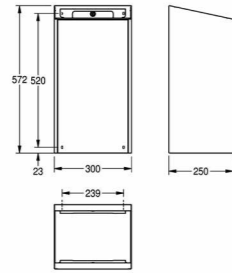
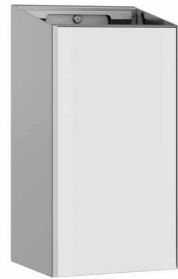

**EXOS. PREMIUM WALL MOUNTED 30 LITRE WASTE BIN - WHITE**

Manufactured from 1.2mm thick grade 1.4301 (304) stainless steel with a satin polish finish and InoxPlus surface refinement which helps reduce the appearance of fingerprints and aids cleaning. Holds approximately 30 litre with integrated bag holder, and mounting bracket. Fixings are included.

3 colour choices  
Capacity: 30 litre waste bin  
Mounting: Wall mounted  
Dimensions: 300 x 572 x 250mm

**EXOS605W** White toughened safety glass front

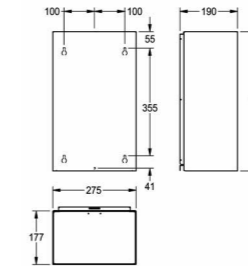

**RODAN WALL MOUNTED 18 LITRE OPEN TOP WASTE BIN**

Manufactured from 0.8mm thick grade 1.4301 (304) stainless steel with a satin polish finish and self-closing waste flap. Holds approximately 18 litres. Mounting bracket and fixings are included.

Capacity: 18 litre waste bin  
Mounting: Wall mounted  
Dimensions: 275 x 460 x 177mm

**RODX605S** Rodan wall mounted 18 litre open top waste bin

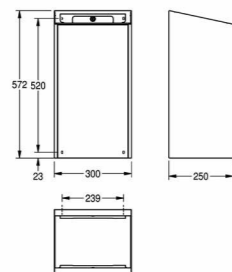

**EXOS. PREMIUM WALL MOUNTED 30 LITRE WASTE BIN - STEEL**

Manufactured from 1.2mm thick grade 1.4301 (304) stainless steel with a satin polish finish and InoxPlus surface refinement which helps reduce the appearance of fingerprints and aids cleaning. Holds approximately 30 litre with integrated bag holder, and mounting bracket. Fixings are included.

3 colour choices  
Capacity: 30 litre waste bin  
Mounting: Wall mounted  
Dimensions: 300 x 572 x 250mm

**EXOS605X** Stainless steel front

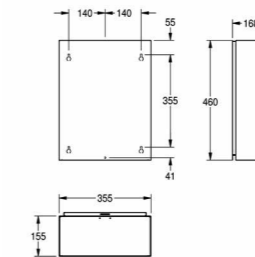

**RODAN WALL MOUNTED 23 LITRE OPEN TOP WASTE BIN**

Manufactured from 0.8mm thick grade 1.4301 (304) stainless steel with a satin polish finish and self-closing waste flap. Holds approximately 23 litres. Mounting bracket and fixings are included.

Capacity: 23 litre waste bin  
Mounting: Wall mounted  
Dimensions: 355 x 460 x 168mm

**RODX605** Waste bin  
**E-RODX605N** Waste bin bag holder

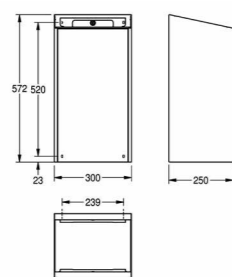

**EXOS. PREMIUM WALL MOUNTED 30 LITRE WASTE BIN - BLACK**

Manufactured from 1.2mm thick grade 1.4301 (304) stainless steel with a satin polish finish and InoxPlus surface refinement which helps reduce the appearance of fingerprints and aids cleaning. Holds approximately 30 litre with integrated bag holder, and mounting bracket. Fixings are included.

3 colour choices  
Capacity: 30 litre waste bin  
Mounting: Wall mounted  
Dimensions: 300 x 572 x 250mm

**EXOS605B** Black toughened safety glass front

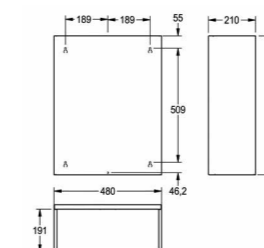

**RODAN WALL MOUNTED 60 LITRE OPEN TOP WASTE BIN**

Manufactured from 0.8mm thick grade 1.4301 (304) stainless steel with a satin polish finish and self-closing waste flap. Holds approximately 60 litres. Mounting bracket and fixings are included.

Capacity: 60 litre waste bin  
Mounting: Wall mounted  
Dimensions: 480 x 620 x 210mm

**RODX607** Open top waste bin  
**RODX608** Self-closing lid

# Hand Drying



W295 x H320 x D165



### AIRBLAST HIGH POWERED HAND DRYER - WHITE

Airblast high powered white hands-under dryer. Ideal for retrofit as the larger body covers screw holes from previous dryers. The Airblast has hygienic touch free operation with blue downlight, and an energy-efficient motor with a switch to chose either ambient or warm air.

Dry time: 10 – 12 sec  
 Supply voltage: 220 – 240 V, 50 – 60 Hz  
 Overall performance: 550 – 1400 W  
 Noise: 78 dB @ 1m  
 Air speed: 110 m/s  
 Dimensions: 295 x 320 x 165mm

**F1390**



W295 x H320 x D165



### AIRBLAST HIGH POWERED HAND DRYER - STEEL

Airblast high powered steel hands-under dryer. Ideal for retrofit as the larger body covers screw holes from previous dryers. The Airblast has hygienic touch free operation with blue downlight, and an energy-efficient motor with a switch to chose either ambient or warm air.

Dry time: 10 – 12 sec  
 Supply voltage: 220 – 240 V, 50 – 60 Hz  
 Overall performance: 550 – 1400 W  
 Noise: 78 dB @ 1m  
 Air speed: 110 m/s  
 Dimensions: 295 x 320 x 165mm

**F1392**



W295 x H320 x D165



### AIRBLAST HIGH POWERED HAND DRYER - BLACK

Airblast high powered black hands-under dryer. Ideal for retrofit as the larger body covers screw holes from previous dryers. The Airblast has hygienic touch free operation with blue downlight, and an energy-efficient motor with a switch to chose either ambient or warm air.

Dry time: 10 – 12 sec  
 Supply voltage: 220 – 240 V, 50 – 60 Hz  
 Overall performance: 550 – 1400 W  
 Noise: 78 dB @ 1m  
 Air speed: 110 m/s  
 Dimensions: 295 x 320 x 165mm

**F1391**

A splash of colour

# NEW The Dartmouth Hand Dryers



3600003365 Dartmouth HD - Steel



AT10-043 Dartmouth HD - Gold



AT10-042 Dartmouth HD - Black

Introducing the Dartmouth eco compact hand dryer - a sleek and stylish addition to any washroom. This touch-free hand dryer is made of grade 304 stainless steel which is durable and easy to clean. The hand dryer is available in a satin or PVD finish in a range of colours, making it easy to match with your washroom decor. With a dry time of just 10 seconds, the Dartmouth eco compact hand dryer is not only fast but also hygienic, helping to reduce the spread of germs.

The hand dryer comes with an automatic shut-off feature after 60 seconds, saving energy and reducing costs. The sensing range is adjustable between 170mm ± 20mm, making it easy to customise the hand dryer to your washroom's needs. It is CE and UKCA certified, ensuring its safety and quality for everyday use.

The compact design of the Dartmouth eco compact hand dryer makes it suitable for any washroom, even those with limited space. Additionally, it has an IP24 rating, making it suitable for use in damp environments. The hand dryer also features a HEPA filter, which reduces airborne bacteria and viruses, promoting a clean and safe washroom environment.

Dry time: 9 sec

Supply voltage: 220 – 240 V, 50 – 60 Hz

Standby power: 0.3 -0.4W

Noise: Min 69 dB @ to 76 dB max

Air speed: 65 - 92 m/s adjustable

Dimensions: 152 x 268 x 100mm

# Hand drying

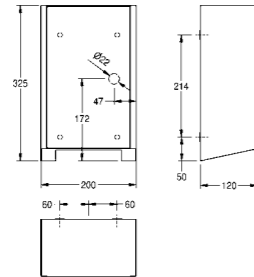

### EXOS HAND DRYER - WHITE

Hand dryer for wall mounting, stainless steel with satin-finish and InoxPlus surface refinement for the reduction of finger marks and better cleaning characteristics (easy to clean), material thickness 1.2mm, with contactless opto-electronic sensor for touch-free operation, adjustable hot air temperature, sensor range adjustable from 10 to 25 cm, protection from continuous operation with automatic switch-off after 60 seconds, air speed adjustable, cable and plug not included.

Operating voltage 220-240V AC, 50-60 Hz  
 Total power 800-1000 W  
 Heater 500 W  
 Motor 500 W  
 Air volume 80 m<sup>3</sup>/h  
 Air velocity 95 - 115 m/s

Dimensions 200 x 325 x 120mm (W x H x D)

**EXOS220W** White toughened safety glass front

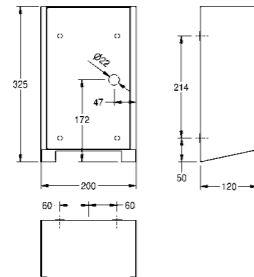

### EXOS HAND DRYER - STEEL

Hand dryer for wall mounting, stainless steel with satin-finish and InoxPlus surface refinement for the reduction of finger marks and better cleaning characteristics (easy to clean), material thickness 1.2mm, with contactless opto-electronic sensor for touch-free operation, adjustable hot air temperature, sensor range adjustable from 10 to 25 cm, protection from continuous operation with automatic switch-off after 60 seconds, air speed adjustable, cable and plug not included.

Operating voltage 220-240V AC, 50-60 Hz  
 Total power 800-1000 W  
 Heater 500 W  
 Motor 500 W  
 Air volume 80 m<sup>3</sup>/h  
 Air velocity 95 - 115 m/s

Dimensions 200 x 325 x 120mm (W x H x D)

**EXOS220X** Stainless steel front

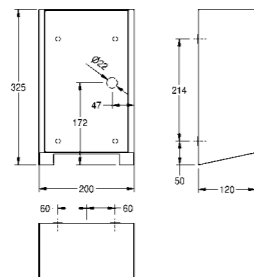

### EXOS HAND DRYER - BLACK

Hand dryer for wall mounting, stainless steel with satin-finish and InoxPlus surface refinement for the reduction of finger marks and better cleaning characteristics (easy to clean), material thickness 1.2mm, with contactless opto-electronic sensor for touch-free operation, adjustable hot air temperature, sensor range adjustable from 10 to 25 cm, protection from continuous operation with automatic switch-off after 60 seconds, air speed adjustable, cable and plug not included.

Operating voltage 220-240V AC, 50-60 Hz  
 Total power 800-1000 W  
 Heater 500 W  
 Motor 500 W  
 Air volume 80 m<sup>3</sup>/h  
 Air velocity 95 - 115 m/s

Dimensions 200 x 325 x 120mm (W x H x D)

**EXOS220B** Black toughened safety glass front

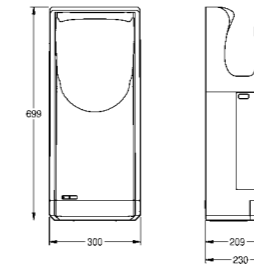

### HANDS IN HAND DRYER

High speed hand dryer for wall mounting, with silver antibacterial ABS casing. Warm or ambient air, adjustable speed and auto shut-down after 25 seconds. Touch free opto-electronically controlled and integrated HEPA filter. The water drainage channel can be cleaned through the removable side panel and tank is easily removed to empty. Ingress Protection rated IPX4.

Dry time: 7 - 10 sec  
 Supply voltage 220-240 V, 50-60 Hz  
 Overall performance 1250-1650 W  
 Noise 65-69 dB @ 1m  
 Air speed 75-100 m/s  
 Water tank capacity 800 ml  
 Dimensions: 300 x 699 x 230mm

**DRYX600** Hands in hand dryer

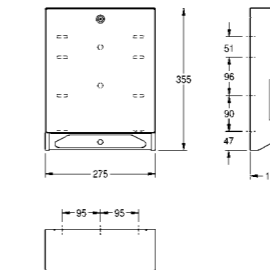

### RODAN PAPER TOWEL DISPENSER

Paper towel dispenser for wall mounting, stainless steel, surface satin finished, material thickness 0.8mm, folded front cover, cylinder lock with KWC standard key, inspection windows on sides, loading capacity 300 - 400 pcs. of paper depending on convolution, includes stainless steel screws and dowels.

Dimensions: 275 x 355 x 112mm

**RODX600** Rodan paper towel dispenser

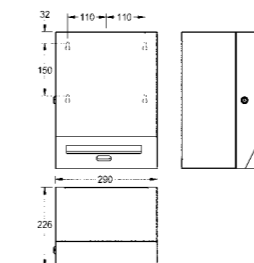

### RODAN ELECTRONIC PAPER TOWEL DISPENSER

Touch free paper towel dispenser for wall mounting, stainless steel, surface satin finished, material thickness 0.8mm, folded cover with cylinder lock and standard KWC key, infrared sensor activity for non-touch operation, integrated tear-off edge, needs 4 pcs. standard D 1.5 V batteries, maintenance free mechanic and easy paper roll change mechanism, for rolls with max. width 205mm and max. diameter 200mm, paper length adjustable to 200, 250 and 300mm, includes stainless steel screws and dowels.

Dimensions: 290 x 390 x 224mm

**RODX630** Rodan electronic paper towel dispenser



# Hand Drying

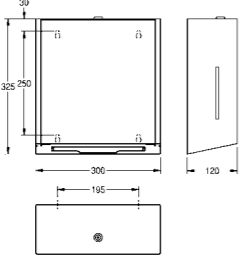

**EXOS. PAPER TOWEL DISPENSER - WHITE**  
 Paper towel dispenser for wall mounting, stainless steel with satin finish, front and casing with InoxPlus surface refinement for the reduction of finger marks and better cleaning characteristics (easy to clean), material thickness 1.2mm, inspection window on side, capacity 300 - 400 pieces of Z-folded paper, includes mounting materials.  
 Dimensions 300 x 325 x 120mm (W x H x D)  
**EXOS600W** White toughened safety glass front

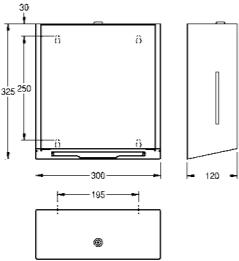

**EXOS. PAPER TOWEL DISPENSER - STEEL**  
 Paper towel dispenser for wall mounting, stainless steel with satin finish, front and casing with InoxPlus surface refinement for the reduction of finger marks and better cleaning characteristics (easy to clean), material thickness 1.2mm, inspection window on side, capacity 300 - 400 pieces of Z-folded paper, includes mounting materials.  
 Dimensions 300 x 325 x 120mm (W x H x D)  
**EXOS600X** Stainless steel front

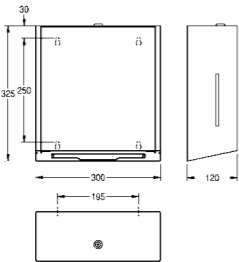

**EXOS. PAPER TOWEL DISPENSER - BLACK**  
 Paper towel dispenser for wall mounting, stainless steel with satin finish, front and casing with InoxPlus surface refinement for the reduction of finger marks and better cleaning characteristics (easy to clean), material thickness 1.2mm, inspection window on side, capacity 300 - 400 pieces of Z-folded paper, includes mounting materials.  
 Dimensions 300 x 325 x 120mm (W x H x D)  
**EXOS600B** Black toughened safety glass front



# Toilet Roll Holders

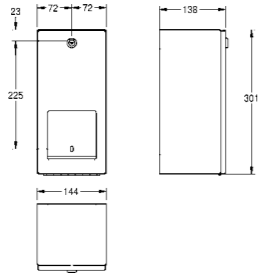

### RODAN DOUBLE TOILET ROLL HOLDER

Double toilet roll holder with spindle system for wall mounting, stainless steel, surface satin finished, material thickness 0.8mm, folded front cover, cylinder lock with KWC standard key, for 2 rolls with max. diameter 120mm, second roll will be released after consumption of first roll, with spindles, reserve roll not visible, includes stainless steel screws and dowels.

Dimensions 144 x 301 x 138mm

**RODX672** Rodan double toilet roll holder

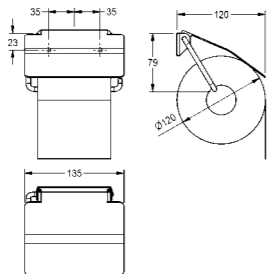

### RODAN TOILET ROLL HOLDER

Toilet roll holder for wall mounting, stainless steel, surface satin finished, material thickness 0.8mm, folding cover, for 1 roll with max. diameter 130mm, includes stainless steel screws and dowels.

Dimensions: 135 x 130 x 25mm

**RODX678** Rodan toilet roll holder

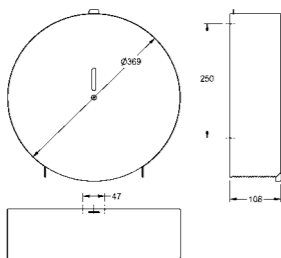

### JUMBO TOILET ROLL HOLDER

Jumbo roll holder for wall mounting, stainless steel, surface satin finished, material thickness 0.8mm, cylinder lock with KWC standard key, closed round casing with inspection window, paper withdrawal over two tear-off edges, for 1 roll with max. diameter 260mm, includes stainless steel screws and dowels.

**CHRX670** 369 x 369 x 108mm

**CHRX669** 269 x 269 x 116mm

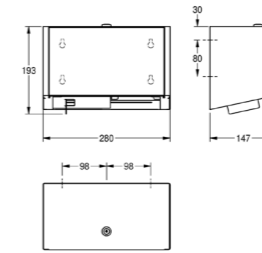

### EXOS. PREMIUM WALL MOUNTED DOUBLE TOILET ROLL HOLDER - WHITE

Manufactured from 1.2mm thick grade 1.4301 (304) stainless steel with a satin polish finish and InoxPlus surface refinement which helps reduce the appearance of fingerprints and aids cleaning.

Dimensions: 147 x 193 x 280mm

**EXOS676W** Wall mounted double toilet roll holder - White

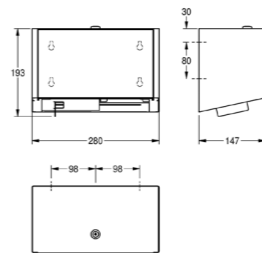

### EXOS. PREMIUM WALL MOUNTED DOUBLE TOILET ROLL HOLDER - STEEL

Manufactured from 1.2mm thick grade 1.4301 (304) stainless steel with a satin polish finish and InoxPlus surface refinement which helps reduce the appearance of fingerprints and aids cleaning.

Dimensions: 147 x 193 x 280mm

**EXOS676X** Wall mounted double toilet roll holder - Steel

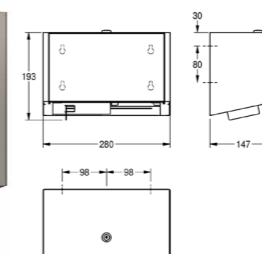

### EXOS. PREMIUM WALL MOUNTED DOUBLE TOILET ROLL HOLDER - BLACK

Manufactured from 1.2mm thick grade 1.4301 (304) stainless steel with a satin polish finish and InoxPlus surface refinement which helps reduce the appearance of fingerprints and aids cleaning.

Dimensions: 147 x 193 x 280mm

**EXOS676B** Wall mounted double toilet roll holder - Black



# GARDA: Elegant Essentials

Aesthetically pleasing, robust and incredibly versatile

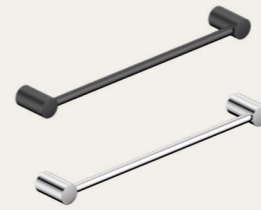

**GARDA Single Towel Rail**  
 GARX001C / 2030068189 (Chrome finish)  
 GARX001B / 2030068224 (Matt black finish)



**GARDA Double Towel Rack**  
 GARX012C / 3600005048 (Chrome finish)  
 GARX012B / 3600005049 (Matt black finish)



**GARDA Towel Ring**  
 GARX104C / 2030068220 (Chrome finish)  
 GARX104B / 2030068229 (Matt black finish)

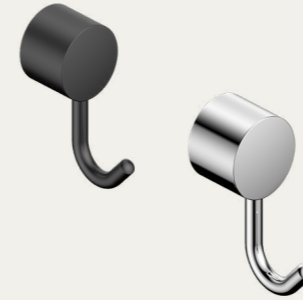

**GARDA Single Robe Hook**  
 GARX010C / 3600005046 (Chrome finish)  
 GARX010B / 3600005047 (Matt black finish)

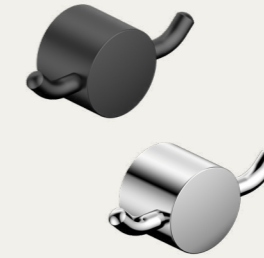

**GARDA Double Robe Hook**  
 GARX011C / 2030068218 (Chrome finish)  
 GARX011B / 2030068227 (Matt black finish)



**GARDA Soap Dish**  
 GARX007C / 2030068219 (Chrome finish)  
 GARX007B / 2030068228 (Matt black finish)



**GARDA Tumbler Holder**  
 GARX006C / 2030068221 (Chrome finish)  
 GARX006B / 2030068230 (Matt black finish)



**GARDA Soap Dispenser**  
 GARX008C / 2030068868 (Chrome finish)  
 GARX008B / 3600005052 (Matt black finish)

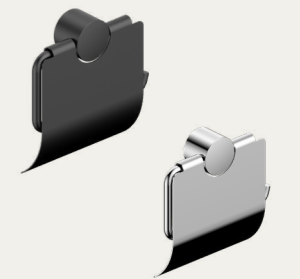

**GARDA Toilet Roll Holder**  
 GARX111C / 2030068196 (Chrome finish)  
 GARX111B / 2030068226 (Matt black finish)



**GARDA Toilet Brush Holder**  
 GARX005C / 2030068222 (Chrome finish)  
 GARX005B / 2030068232 (Matt black finish)



# VICO: Sophisticated Bathroom Accents

Visually appealing and functional

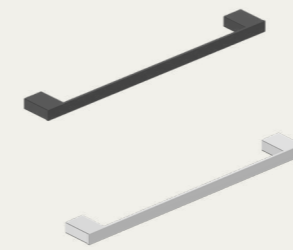

**VICO Single Towel Rail**  
 VICX001C / 2030068233 (Chrome finish)  
 VICX001B / 2030068240 (Matt black finish)

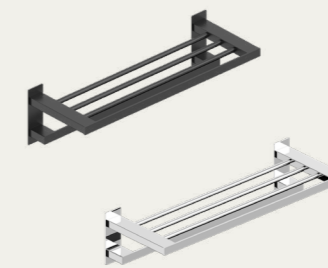

**VICO Double Towel Rack**  
 VICX012C / 3600005050 (Chrome finish)  
 VICX012B / 3600005051 (Matt black finish)

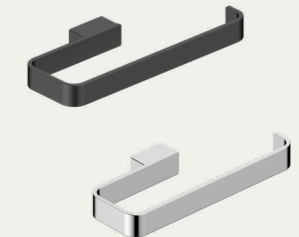

**VICO Towel Arm**  
 VICX004C / 2030068237 (Chrome finish)  
 VICX004B / 2030068244 (Matt black finish)

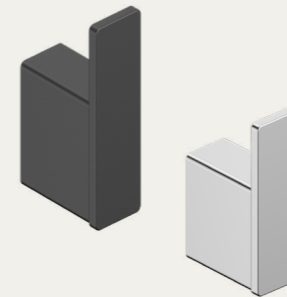

**VICO Single Robe Hook**  
 VICX010C / 3600002522 (Chrome finish)  
 VICX010B / 3600002523 (Matt black finish)

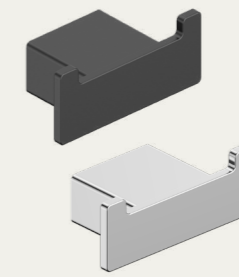

**VICO Double Robe Hook**  
 VICX0110C / 2030068235 (Chrome finish)  
 VICX0110B / 2030068242 (Matt black finish)

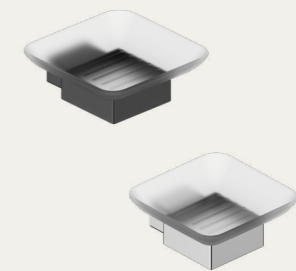

**VICO Soap dish**  
 VICX007C / 2030068236 (Chrome finish)  
 VICX007B / 2030068243 (Matt black finish)

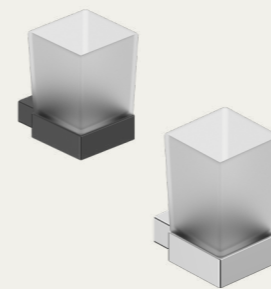

**VICO Tumbler Holder**  
 VICX006C / 2030068238 (Chrome finish)  
 VICX006B / 2030068245 (Matt black finish)



**VICO Soap Dispenser**  
 VICX008C / 2030068718 (Chrome finish)  
 VICX008B / 2030068617 (Matt black finish)

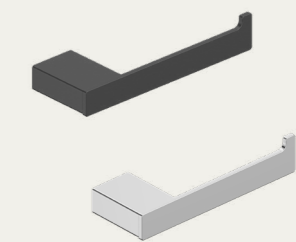

**VICO Toilet Roll Holder**  
 VICX111C / 2030068234 (Chrome finish)  
 VICX111B / 2030068341 (Matt black finish)



**VICO Toilet Brush Holder**  
 VICX005C / 2030068239 (Chrome finish)  
 VICX005B / 2030068246 (Matt black finish)

# Bathroom accessories



**CUBUS TOWEL ARM**  
 Manufactured from high polished grade 304 stainless steel. Designed with concealed fixings. Mounting: Wall mounted  
 Finish: High polished  
 Dimensions: 85 x 262 x 54mm

**CUBX004HP** High polished  
**CUBX004** Satin



**CUBUS SINGLE TOWEL RAIL**  
 Manufactured from high polished grade 304 stainless steel. Designed with concealed fixings. Mounting: Wall mounted  
 Finish: High polished  
 Dimensions: 80 x 600 x 54mm

**CUBX001HP** High polished  
**CUBX001** Satin



**CUBUS DOUBLE TOWEL RAIL**  
 Manufactured from high polished grade 304 stainless steel. Designed with concealed fixings. Mounting: Wall mounted  
 Finish: High polished  
 Dimensions: 125 x 600 x 54mm

**CUBX002HP** High polished  
**CUBX002** Satin



**CUBUS TOWEL RACK**  
 Manufactured from high polished grade 304 stainless steel. Designed with concealed fixings. Mounting: Wall mounted  
 Finish: High polished  
 Dimensions: 220 x 600 x 122mm

**CUBX012HP** High polished  
**CUBX012** Satin



**MEDIUS TOWEL ARM**  
 Manufactured from high polished grade 304 stainless steel. Designed with concealed fixings. Mounting: Wall mounted  
 Finish: High polished  
 Dimensions: 170 x 65 x 60mm

**MEDX004HP** High polished  
**MEDX004** Satin



**MEDIUS TOWEL RAIL**  
 Manufactured from high polished grade 304 stainless steel. Designed with concealed fixings. Mounting: Wall mounted  
 Finish: High polished  
 Dimensions: 85 x 600 x 54mm

**MEDX001HP** High polished  
**MEDX001** Satin



**MEDIUS DOUBLE TOWEL RAIL**  
 Manufactured from high polished grade 304 stainless steel. Designed with concealed fixings. Mounting: Wall mounted  
 Finish: High polished  
 Dimensions: 125 x 600 x 54mm

**MEDX002HP** High polished  
**MEDX002** Satin



**MEDIUS TOWEL RACK**  
 Manufactured from high polished grade 304 stainless steel. Designed with concealed fixings. Mounting: Wall mounted  
 Finish: High polished  
 Dimensions: 220 x 600 x 120mm

**MEDX012HP** High polished  
**MEDX012** Satin



**CUBUS SINGLE ROBE HOOK**  
 Manufactured from high polished grade 304 stainless steel. Mounting: Wall mounted  
 Finish: High polished  
 Dimensions: 60 x 54 x 54mm

**CUBX010HP** High polished  
**CUBX010** Satin



**CUBUS TOILET ROLL HOLDER WITH COVER**  
 Manufactured from high polished grade 304 stainless steel. Mounting: Wall mounted  
 Finish: High polished  
 Dimensions: 85 x 165 x 54mm

**CUBX111HP** High polished  
**CUBX111** Satin



**CUBUS TOILET ROLL HOLDER**  
 Manufactured from high polished grade 304 stainless steel. Mounting: Wall mounted  
 Finish: High polished  
 Dimensions: 165 x 85 x 54mm

**CUBX211HP** High polished  
**CUBX211** Satin



**CUBUS TOILET BRUSH HOLDER**  
 Manufactured from high polished grade 304 stainless steel. Mounting: Wall mounted  
 Finish: High polished  
 Dimensions: 135 x 147 x 340mm

**CUBX005HP** High polished  
**CUBX005** Satin



**MEDIUS TOWEL RING**  
 Manufactured from high polished grade 304 stainless steel. Mounting: Wall mounted  
 Finish: High polished  
 Dimensions: 65 x 177 x 198mm

**MEDX104HP** High polished  
**MEDX104** Satin



**MEDIUS SINGLE ROBE HOOK**  
 Manufactured from high polished grade 304 stainless steel. Mounting: Wall mounted  
 Finish: High polished  
 Dimensions: 55 x 54 x 54mm

**MEDX010HP** High polished  
**MEDX010** Satin



**MEDIUS DOUBLE ROBE HOOK**  
 Manufactured from high polished grade 304 stainless steel. Mounting: Wall mounted  
 Finish: High polished  
 Dimensions: 70 x 74 x 54mm

**MEDX011HP** High polished  
**MEDX011** Satin



**MEDIUS TOILET ROLL HOLDER WITH COVER**  
 Manufactured from high polished grade 304 stainless steel. Mounting: Wall mounted  
 Finish: High polished  
 Dimensions: 66 x 140 x 160mm

**MEDX111HP** High polished  
**MEDX111** Satin



**CUBUS TUMBLER HOLDER WITH GLASS**  
 Manufactured from high polished grade 304 stainless steel. Mounting: Wall mounted  
 Finish: High polished  
 Dimensions: 115 x 217 x 85mm

**CUBX006HP** High polished  
**CUBX006** Satin



**CUBUS SOAP DISH HOLDER WITH GLASS**  
 Manufactured from high polished grade 304 stainless steel. Mounting: Wall mounted  
 Finish: High polished  
 Dimensions: 135 x 147 x 54mm

**CUBX007HP** High polished  
**CUBX007** Satin



**CUBUS CORNER SHOWER BASKET**  
 Manufactured from high polished grade 304 stainless steel. Mounting: Wall mounted  
 Finish: High polished  
 Dimensions: 95 x 150 x 50mm

**MISX0009HP** High polished  
**MISX0009** Satin



**STRATOS CLOTHES HOOK**  
 Manufactured from grade 1.4301 (304) stainless steel. 18mm tube with a satin polish finish. Fixings are included.  
 Dimensions: 18 x 38 x 60mm  
**STRX692**



**MEDIUS TOILET BRUSH HOLDER**  
 Manufactured from high polished grade 304 stainless steel. Mounting: Wall mounted  
 Finish: High polished  
 Dimensions: 140 x 115 x 340mm

**MEDX005HP** High polished  
**MEDX005** Satin



**MEDIUS TUMBLER HOLDER WITH GLASS**  
 Manufactured from high polished grade 304 stainless steel. Mounting: Wall mounted  
 Finish: High polished  
 Dimensions: 105 x 70 x 100mm

**MEDX006HP** High polished  
**MEDX006** Satin



**MEDIUS SOAP DISH WITH GLASS DISH**  
 Manufactured from high polished grade 304 stainless steel. Mounting: Wall mounted  
 Finish: High polished  
 Dimensions: 125 x 110 x 55mm

**MEDX007HP** High polished  
**MEDX007** Satin



**STRATOS CLOTHES HOOK**  
 Manufactured from grade 1.4301 (304) stainless steel. 18mm tube with a satin polish finish. Fixings are included.  
 Dimensions: 69 x 18 x 60mm  
**STRX694**



## Ligature resistant and High-security

Unlike traditional sanitaryware, our range of high-security and ligature resistant products are virtually unbreakable. The safe ensembles feature glass reinforced polyester (GRP) security basins, WCs, and accessories. This material is a single skin configuration which has three different weaves of glass fibre to give the product excellent structural integrity, this is then impregnated with polyester resin to produce strong and extremely durable composite material.

Our high-security range also features a suite of stainless steel elements, including spouts, washbasin and WC combination units and an array of high-security stainless steel accessories. This comprehensive range redefines safety and security, offering products that are not only durable but also designed to meet the most stringent security requirements.

# Ligature resistant WCs

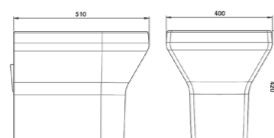

## BACK TO WALL WC PAN

High-security WC pan, manufactured from GRP high performance composite material. Designed and tested to be vandal-proof and avoid ligature points wherever possible. The techniques employed to construct these pans are used very successfully in the field of ballistic armour manufacturing, this results in unrivalled impact resistance. A high-grade non-porous polyester gel coat surface specially formulated to resist chemicals and ultraviolet rays comes as standard.

Dimensions: 400 x 420 x 510mm

- VR01-010** White WC pan
- Complimentary accessories:**
- SP18-035** Painting of WC pan seat - non-standard colour



Any RAL colour is possible

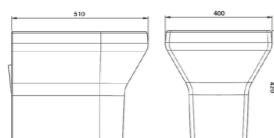

## BACK TO WALL WC PAN - BLUE TOP (RAL 5011)

High-security WC pan with blue top, manufactured from GRP high performance composite material. Designed and tested to be vandal-proof and avoid ligature points wherever possible. The techniques employed to construct these pans are used very successfully in the field of ballistic armour manufacturing, this results in unrivalled impact resistance. A high-grade non-porous polyester gel coat surface specially formulated to resist chemicals and ultraviolet rays comes as standard.

Dimensions: 400 x 420 x 510mm

- VR01-034** Blue top WC pan

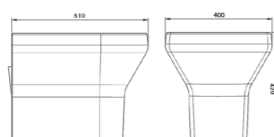

## BACK TO WALL WC PAN - GREY TOP (RAL 7040)

High-security WC pan with grey top, manufactured from GRP high performance composite material. Designed and tested to be vandal-proof and avoid ligature points wherever possible. The techniques employed to construct these pans are used very successfully in the field of ballistic armour manufacturing, this results in unrivalled impact resistance. A high-grade non-porous polyester gel coat surface specially formulated to resist chemicals and ultraviolet rays comes as standard.

Dimensions: 400 x 420 x 510mm

- VR01-071** Grey top WC pan

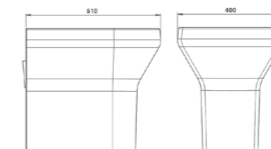

## ACCESSIBLE WC PAN

High-security accessible WC pan, manufactured from GRP high performance composite material. Designed and tested to be vandal-proof and avoid ligature points wherever possible. The techniques employed to construct these pans are used very successfully in the field of ballistic armour manufacturing, this results in unrivalled impact resistance. A high-grade non-porous polyester gel coat surface specially formulated to resist chemicals and ultraviolet rays comes as standard.

Dimensions: 400 x 480 x 510mm

- VR01-011** White WC pan
- Complimentary accessories:**
- VR01-119** WC spacer box
- SP18-035** Painting of WC pan seat - non-standard colour



Any RAL colour is possible

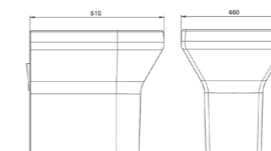

## ACCESSIBLE WC PAN - BLUE TOP (RAL 5011)

High-security accessible WC pan with blue top, manufactured from GRP high performance composite material. Designed and tested to be vandal-proof and avoid ligature points wherever possible. The techniques employed to construct these pans are used very successfully in the field of ballistic armour manufacturing, this results in unrivalled impact resistance. A high-grade non-porous polyester gel coat surface specially formulated to resist chemicals and ultraviolet rays comes as standard.

Dimensions: 400 x 480 x 510mm

- VR01-035** Blue top WC pan
- Complimentary accessories:**
- VR01-119** WC spacer box

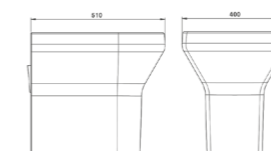

## ACCESSIBLE WC PAN - GREY TOP (RAL 7040)

High-security accessible WC pan with grey top, manufactured from GRP high performance composite material. Designed and tested to be vandal-proof and avoid ligature points wherever possible. The techniques employed to construct these pans are used very successfully in the field of ballistic armour manufacturing, this results in unrivalled impact resistance. A high-grade non-porous polyester gel coat surface specially formulated to resist chemicals and ultraviolet rays comes as standard.

Dimensions: 400 x 480 x 510mm

- VR01-072** Grey top WC pan
- Complimentary accessories:**
- VR01-119** WC spacer box

# Ligature resistant WCs

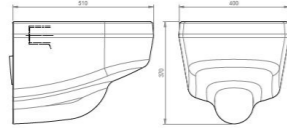

## WALL HUNG WC PAN

High-security WC pan, manufactured from GRP high performance composite material. Designed and tested to be vandal-proof and avoid ligature points wherever possible. The techniques employed to construct these pans are used very successfully in the field of ballistic armour manufacturing, this results in unrivalled impact resistance. A high-grade non-porous polyester gel coat surface specially formulated to resist chemicals and ultraviolet rays comes as standard.

Fixing kit for walls up to 250mm provided as standard  
Dimensions: 400 x 370 x 510mm

**VR01-017** White WC pan wall hung

### Complimentary accessories:

**SP18-035** Painting of WC pan seat - non-standard colour



Any RAL colour is possible

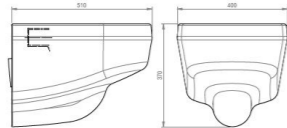

## WALL HUNG WC PAN - BLUE TOP (RAL 5011)

High-security WC pan, manufactured from GRP high performance composite material. Designed and tested to be vandal-proof and avoid ligature points wherever possible. The techniques employed to construct these pans are used very successfully in the field of ballistic armour manufacturing, this results in unrivalled impact resistance. A high-grade non-porous polyester gel coat surface specially formulated to resist chemicals and ultraviolet rays comes as standard.

Fixing kit for walls up to 250mm provided as standard  
Dimensions: 400 x 370 x 510mm

**VR01-036** Blue WC pan wall hung

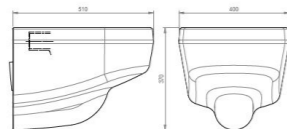

## WALL HUNG WC PAN - GREY TOP (RAL 7040)

High-security WC pan, manufactured from GRP high performance composite material. Designed and tested to be vandal-proof and avoid ligature points wherever possible. The techniques employed to construct these pans are used very successfully in the field of ballistic armour manufacturing, this results in unrivalled impact resistance. A high-grade non-porous polyester gel coat surface specially formulated to resist chemicals and ultraviolet rays comes as standard.

Fixing kit for walls up to 250mm provided as standard  
Dimensions: 400 x 370 x 510mm

**VR01-073** Grey WC pan wall hung

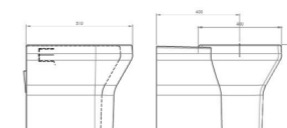

## CORNER FIT WC PAN

Corner fit high-security WC pan, manufactured from GRP high performance composite material. Designed and tested to be vandal-proof and avoid ligature points wherever possible. The techniques employed to construct these pans are used very successfully in the field of ballistic armour manufacturing, this results in unrivalled impact resistance. A high-grade non-porous polyester gel coat surface specially formulated to resist chemicals and ultraviolet rays comes as standard.

Dimensions: 600 x 420 x 510mm

**VR01-013** WC pan left hand corner fit

**VR01-014** WC pan right hand corner fit

### Complimentary accessories:

**SP18-035** Painting of WC pan seat - non-standard colour



Any RAL colour is possible

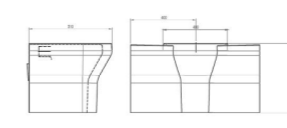

## ENCLOSED FIT WC PAN

Enclosed fit high-security WC pan, manufactured from GRP high performance composite material. Designed and tested to be vandal-proof and avoid ligature points wherever possible. The techniques employed to construct these pans are used very successfully in the field of ballistic armour manufacturing, this results in unrivalled impact resistance. A high-grade non-porous polyester gel coat surface specially formulated to resist chemicals and ultraviolet rays comes as standard.

Dimensions: 800 x 420 x 510mm

**VR01-046** WC pan enclosed fit

### Complimentary accessories:

**SP18-035** Painting of WC pan seat - non-standard colour



Any RAL colour is possible

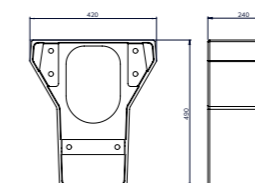

## GRP ACCESSIBLE WC SPACER BOX

GRP accessible WC spacer box for "against wall" installations. Manufactured from Glass reinforced polyester with a white high gloss gelcoat finish. Designed with wheelchair access in mind, providing ease of use. Optional extra for use with all KWC DVS less-abled height back to wall WC pans.

Dimensions: 420 x 490 x 240mm

**VR01-119** WC spacer box



# Ligature resistant basins

**NEW**  
**INFORM**  
ENABLED

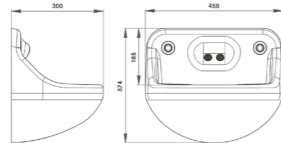

## SAFE ENSUITE INTEGRATED BASIN

Safe Ensuite integrated basin, manufactured from GRP high performance composite material. Designed and tested to be vandal-proof and avoid ligature points wherever possible. The techniques employed to construct these basins are used very successfully in the field of ballistic armour manufacturing, this results in unrivalled impact resistance. A high-grade non-porous polyester gel coat surface specially formulated to resist chemicals and ultraviolet rays comes as standard.

Control, sensors and TMV3 required  
Dimensions: 450 x 374 x 300mm

**VR01-030** Integrated basin

INFORM enabled; additional parts and subscription required to activate wireless temperature monitoring and using data. and using data.

**NEW**  
**INFORM**  
ENABLED

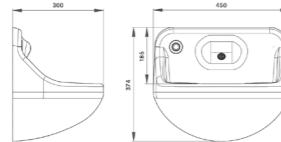

## SAFE ENSUITE SINGLE OUTLET BASIN

Safe Ensuite basin, manufactured from GRP high performance composite material. Designed and tested to be vandal-proof and avoid ligature points wherever possible. The techniques employed to construct these basins are used very successfully in the field of ballistic armour manufacturing, this results in unrivalled impact resistance. A high-grade non-porous polyester gel coat surface specially formulated to resist chemicals and ultraviolet rays comes as standard.

Control, sensors and TMV3 required  
Dimensions: 450 x 374 x 300mm

**VR01-090** Dual sensor, single outlet

**VR01-092** Single sensor, single outlet

INFORM enabled; additional parts and subscription required to activate wireless temperature monitoring and using data.

**NEW**  
**INFORM**  
ENABLED

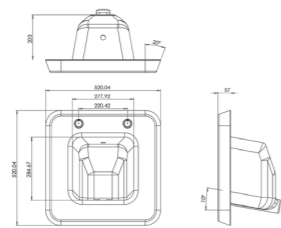

## IN-WALL BASIN

Safe Ensuite in wall basin, manufactured from GRP high performance composite material. Designed and tested to be vandal-proof and avoid ligature points wherever possible. The techniques employed to construct these basins are used very successfully in the field of ballistic armour manufacturing, this results in unrivalled impact resistance. A high-grade non-porous polyester gel coat surface specially formulated to resist chemicals and ultraviolet rays comes as standard.

Control, sensors and TMV3 required  
Dimensions: 465 x 210 x 305

**VR01-085** In-wall basin

**VR01-125** Dual outlet in-wall basin

INFORM enabled; additional parts and subscription required to activate wireless temperature monitoring and using data.

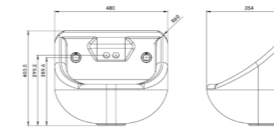

## SAFE ENSUITE HIGH-SIDED BASIN

Safe Ensuite integrated basin, manufactured from GRP high performance composite material. Designed and tested to be vandal-proof and avoid ligature points wherever possible. The techniques employed to construct these basins are used very successfully in the field of ballistic armour manufacturing, this results in unrivalled impact resistance. A high-grade non-porous polyester gel coat surface specially formulated to resist chemicals and ultraviolet rays comes as standard.

Control, sensors and TMV3 required  
Dimensions: 290 x 390 x 20

**VR01-080** High-sided basin

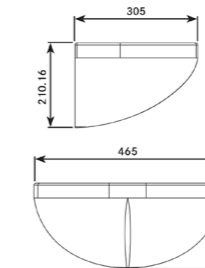

## LOW PROFILE BASIN WITHOUT TAP HOLES

Low profile basin, manufactured from GRP high performance composite material. Designed and tested to be vandal-proof and avoid ligature points wherever possible. The techniques employed to construct these basins are used very successfully in the field of ballistic armour manufacturing, this results in unrivalled impact resistance. A high-grade non-porous polyester gel coat surface specially formulated to resist chemicals and ultraviolet rays comes as standard.

Control, sensors, TMV3, spout or backplate required  
Dimensions: 465 x 210 x 305

**VR01-081** Without tap holes

**VR01-082** Left hand tap hole

**VR01-083** Right hand tap hole

**VR01-084** Two tap holes

**NEW FOR 2024**

## HIGH-SECURITY VANITY BASIN WITH TMV3

Floor standing Trespa vanity unit with integrated GRP wash basin. The basin is ligature resistant and has been designed and tested to be vandal-proof and avoid ligature points wherever possible. The techniques employed to construct these basins are used very successfully in the field of ballistic armour manufacturing, this results in unrivalled impact resistance. A high-grade non-porous polyester gel coat surface specially formulated to resist chemicals and ultraviolet rays comes as standard. Designed pre-assembled for easy installation with TMV spouts and controls included in kit form.

Available with wave-on or tactile operation  
Dimensions: 492 x 830 x 397mm

**VR01-120** High-Security vanity basin with 2 taps and 2 sensors

**VR01-121** High-Security vanity basin with 1 tap and 2 sensors

**VR01-122** High-Security vanity basin no outlets

**Complimentary accessories:**

**VR01-130** Vandal resistant vanity cabinet

INFORM enabled; additional parts and subscription required to activate wireless temperature monitoring and using data.

**NEW**  
**INFORM**  
ENABLED

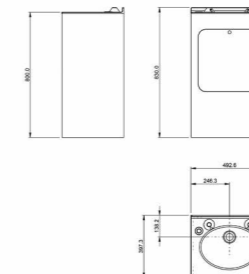

# Ligature resistant taps and spouts

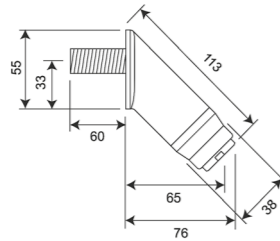

## HIGH-SECURITY WALL MOUNTED TAP SPOUT 45°

45° High-security tap spout, manufactured in 316 stainless steel with a brushed finish. Designed for mental healthcare and high security environments with fully ligature resistant design, conforming to the safer cell standards and testing. Additional TMV3 required. WRAS approved 5 litre per minute outlet.

Requires sensor and station kit to operate  
Additional TMV3 required  
Dimensions: 38 x 113 x 76mm

**AT07-040** Wall mounted tap spout 45°

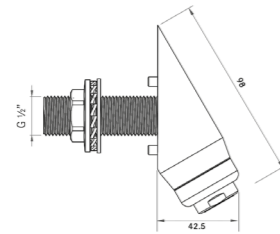

## HIGH-SECURITY WALL MOUNTED TAP SPOUT 30°

30° High-security tap spout, manufactured in 316 stainless steel with a brushed finish. Ligature-resistant design. WRAS approved 5 litre per minute outlet.

Ø½" DZR Brass BSP connection  
Requires sensor and station kit to operate  
Additional TMV3 required  
Dimensions: 38 x 113 x 76mm

**AT07-041** Wall mounted tap spout 30°

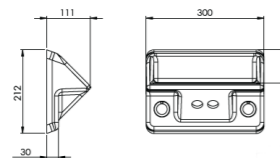

## HIGH-SECURITY SAFE ENSUITE BACK PLATE

The High Security Safe Ensuite Backplate design is aesthetically pleasing, and is designed be used in conjunction with our latest range of Safe Ensuite Low Profile Basins.

Requires sensor and station kit to operate  
Additional TMV3 required  
Dimensions: 300 x 212 x 111mm

**VR01-107** Safe ensuite back plate

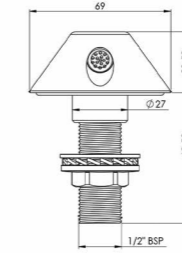

## ANGLED DECK MOUNTED BASIN SPOUT

High-security deck mounted spout manufactured in 316 stainless steel with a brushed finish. Designed for mental healthcare and high security environments with fully ligature resistant design, conforming to the safer cell standards and testing. Additional TMV3 required.

Ø½" DZR Brass BSP connection  
Requires sensor and station kit to operate  
Dimensions: 69 x 30 x 69mm

**AT07-092** Basin spout

**Complimentary accessories:**

**AC17-042** Restrictaflow in-line flow restricting valve

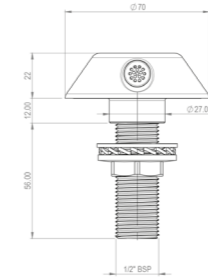

## HIGH-SECURITY DECK MOUNTED SPOUT

High-security deck mounted spout manufactured in 316 stainless steel with a brushed finish. Designed for mental healthcare and high security environments with fully ligature resistant design, conforming to the safer cell standards and testing. Additional TMV3 required.

DZR Brass BSP connection  
Requires sensor and station kit to operate  
Dimensions: 70 x 22 x 70mm

**AT07-056** High-security spout

**Complimentary accessories:**

**AC17-042** Restrictaflow in-line flow restricting valve

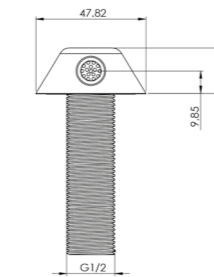

## HIGH-SECURITY DECK MOUNTED SPOUT

High-security deck mounted spout manufactured in 316 stainless steel with a brushed finish. Designed for mental healthcare and high security environments with fully ligature resistant design, conforming to the safer cell standards and testing. Additional TMV3 required.

DZR Brass BSP connection  
Requires sensor and station kit to operate  
Dimensions: 48 x 20mm

**AT07-058** High-security spout

**Complimentary accessories:**

**AC17-042** Restrictaflow in-line flow restricting valve

# Ligature Resistant & High Security Showers

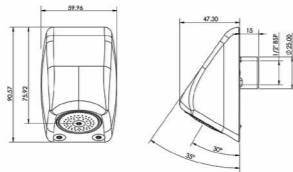

## ANTI-MICROBIAL SHOWERHEAD

Anti-microbial showerhead manufactured from brass with a chrome finished cover. Supplied with removable waterway that is manufactured in four different colours with anti-microbial Biomaster silver ion technology. The ligature resistant heads also feature a one-piece anti-microbial ABS outlet.

Requires sensor and station kit to operate  
Additional TMV3 required  
Dimensions: 60 x 90 x 47mm

**SH07-095** Anti-microbial showerhead

### Complimentary accessories:

**SH00-070** Replacement Coloured Waterways (Set of 4)

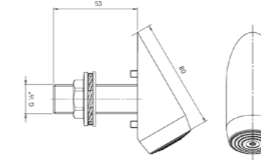

## HIGH SECURITY SHOWERHEAD – 30°

30° high-security shower head with 4 ring shower rose. Manufactured from 316 stainless steel with a brushed finish. Anti-ligature design, with a tamper proof security locking screw. Anti-rotation pins.

Additional TMV3 required  
Sensor and station kit required

**SH07-040** High security showerhead – 30°

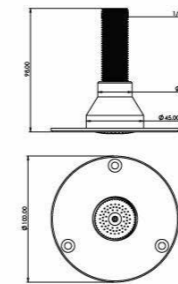

## FLUSH MOUNTED CEILING SHOWERHEAD

An Aesthetically pleasing take on Ceiling Height Showerheads whilst maintaining Ligature & Vandal Resistant Design. Ceiling Height High-Security Shower Head with a One-Piece Anti-Microbial ABS outlet. Anti-ligature design, with a tamper-proof security locking screw. Brushed Stainless Steel finish.

Additional TMV3 required  
Sensor and station kit required

**SH07-047** Flush mounted ceiling showerhead

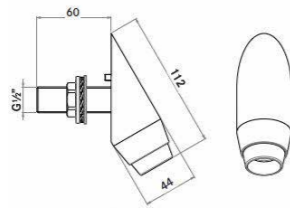

## HIGH SECURITY SHOWERHEAD WITH DETACHABLE HOSE CONNECTION

High Security Showerhead with Detachable Hose Connection. The SH07-084 is intended for installations where everything except the showerhead and sensor are concealed behind a wall or panel. This product can be utilised on its own or as part of a shower pairing with the SH07-040. This showerhead can be used in conjunction with the KWC DVS Shower Control System.

Features include: – 316 Stainless steel – Easy to install – Quick release mechanism for ease of connection and disconnection of hose and handset (Hose & Handset Included) – Ideal for areas where ligature resistance is required – Wall mounted – Perfect for assisted showering areas

Additional TMV3 required  
Sensor and station kit required

**SH07-084** High security showerhead

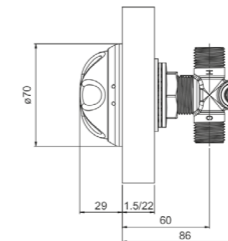

## LIGATURE RESISTANT TEMPERATURE BLENDING VALVE ADJUSTER

Temperature blending valve adjuster, manufactured from brass with a chrome finish. Designed to be robust with good aesthetics and therefore suits all applications. Manufactured with a robust construction and tamper proof design. Easy to install.

Dimensions: 70 x 70mm (W x H)

**SH00-011** Wall thickness compatibility 1.5mm - 22mm

**SH00-012** Wall thickness compatibility 22mm - 180mm

**SH00-013** Wall thickness compatibility 180mm - 280mm

### Mandatory accessories:

**AC17-047** TMV3

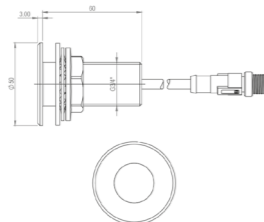

## STAINLESS STEEL PROGRAMMABLE SHOWER SENSOR

The NEW wall Mounted Programmable Sensor is to be used in conjunction with the handheld programmer (AC01-001). The programmer will allow quick and easy adjustment of settings including; run-on time, range, purge and more. Real time data can be uploaded from the programmer via the USB port to allow accurate monitoring of water efficiency. Available in stainless steel as standard or PVD coated in a choice of black or gold, please get in touch to enquire about coloured options.

Station kit required  
Dimensions: 50 x 50 x 60mm

**AC02-021** Programmable sensor

### Mandatory accessories:

**AT00-221** Station kit

**AC17-047** TMV3

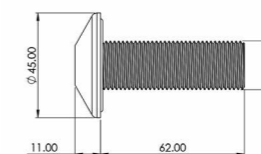

## 12V SHOWER TACTILE AND WAVE-ON SENSORS

Wave-on shower sensor manufactured from stainless steel complete with a 45mm bezel.

Complete with 15 metre cable  
Separate control box required  
Thread diameter: 1/2" BSP  
Dimensions: 45 x 45 x 73mm

**SH00-003** Wave-on sensor

### OR

**AC02-050** Red tactile switch (hot) (wall mount)

### Mandatory accessories:

**AC17-101** Solenoid valve (1 required per sensor)

KWC DVS washrooms

# INFORM Outlet showers with remote monitoring and control

NEW  
INFORM  
ENABLED

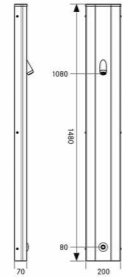

NEW FOR 2024

## INFORM OUTLET CEILING HEIGHT SHOWER TOWER - TACTILE

INFORM Outlet Ceiling height shower tower, manufactured from 316 stainless steel with a brushed finish. Features an anti-microbial outlet and in-built intelligent thermistors which connect to our INFORM system. Remotely monitor temperatures, control the outlet, and collate usage data. Ligature-resistant design with concealed pipework, and in-built TMV3 for high-security applications. Designed to fit flush against the ceiling. Tactile switch is positioned 1 metre from floor level at standard 2.4metre ceiling height.

Built-in TMV3  
Tactile switch operation  
Dimensions: 200 x 1080 x 70mm  
Available in White

IC04-005 INFORM shower tower - Tactile

### Mandatory accessories:

IC07-006 INFORM 6 channel control

OR

IC07-012 INFORM 12 channel control

INFORM enabled; additional parts and subscription required to activate wireless temperature monitoring and using data.

NEW FOR 2024

## INFORM OUTLET CEILING HEIGHT SHOWER TOWER - SENSOR

INFORM Outlet Ceiling height shower tower, manufactured from 316 stainless steel with a brushed finish. Features an anti-microbial outlet and in-built intelligent thermistors which connect to our INFORM system. Remotely monitor temperatures, control the outlet, and collate usage data. Ligature-resistant design with concealed pipework, and in-built TMV3 for high-security applications. Designed to fit flush against the ceiling. Sensor is positioned 1 metre from floor level at standard 2.4metre ceiling height.

Built-in TMV3  
Sensor operation  
Control box required  
Dimensions: 200 x 1080 x 70  
Available in White

IC04-006 INFORM Shower tower - Sensor

### Mandatory accessories:

IC07-006 INFORM 6 channel control

OR

IC07-012 INFORM 12 channel control

INFORM enabled; additional parts and subscription required to activate wireless temperature monitoring and using data.

# INFORM OUTLET

## Shower Safety Redefined with INFORM Technology

Elevate your showers to the apex of safety and effortless control with our stainless-steel shower towers featuring the INFORM enabled shower head. This innovative head boasts an advanced anti-microbial design, promoting hygiene and peace of mind. Integrated intelligent thermistors seamlessly connect with INFORM, providing real-time temperature monitoring, usage data, and customizable alarms.

KWC DVS INFORM empowers informed action. Should pre-set temperature parameters fall outside safe ranges, the system notifies you allowing for timely and efficient intervention. This translates to complete confidence in your water safety standards, all within seconds.

NEW  
INFORM  
ENABLED

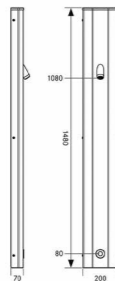

# Ligature resistant and high security showers

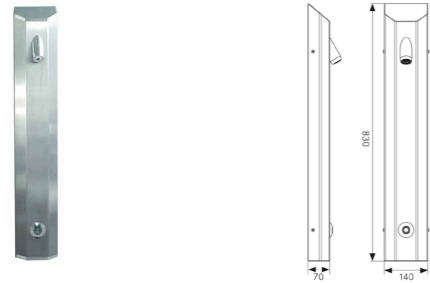

## STANDARD SHOWER TOWER

Standard angled top shower tower, manufactured from 316 stainless steel with a brushed finish. Suitable for high-security applications. Designed with concealed pipework.

Wave-on sensor or tactile switch operation  
 Dimensions: 140 x 830 x 70mm  
 Available in White

**SH01-002** Shower tower - Wave-on

**SH01-003** Shower tower - Tactile

**Mandatory accessories:**

**SH07-001** Shower control system

**AC17-047** Thermostatic mixing valve

**Complimentary accessories:**

**AC17-080** Thermal disinfection valve

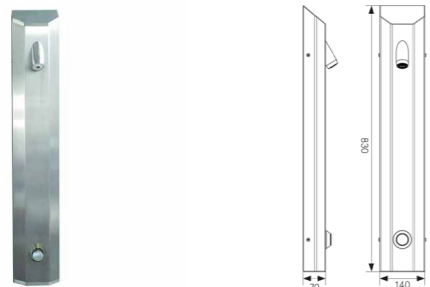

## STANDARD SHOWER TOWER - PUSH BUTTON

Standard angled top shower tower, manufactured from 316 stainless steel with a brushed finish.

Dimensions: 140 x 830 x 70mm  
 Available in White

**SH01-001** Shower tower

**Mandatory accessories:**

**AC17-047** Thermostatic mixing valve

**Complimentary accessories:**

**AC17-080** Thermal disinfection valve

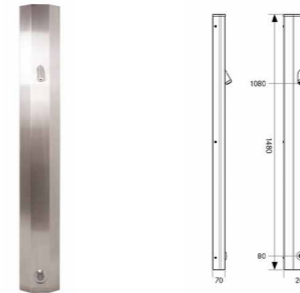

## CEILING HEIGHT SHOWER TOWER TMV3 - MAINS

Ceiling height shower tower, manufactured from 316 stainless steel with a brushed finish. Suitable for high security applications. Ligature-resistant design with concealed pipework, and in-built TMV3 for high-security applications. Designed to fit flush against the ceiling. Control is positioned 1 metre from floor level at standard 2.4metre ceiling height.

Built-in TMV3

Tactile or sensor operation

Dimensions: 200 x 1080 x 70mm

Available in White

**SH01-005** Tactile ceiling height shower tower

**SH01-006** Sensor ceiling height shower tower

**Mandatory accessories:**

**SH07-001** Shower control system

**Complimentary accessories:**

**AC17-080** Thermal disinfection valve

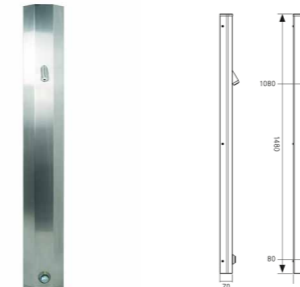

## CEILING HEIGHT SHOWER TOWER - SELF-CLOSING

Ceiling height shower tower, manufactured from 316 stainless steel with a brushed finish. Ligature-resistant design with concealed pipework, and in-built TMV3 for high-security applications. Designed to fit flush against the ceiling. Push button is positioned 1 metre from floor level at standard 2.4metre ceiling height.

Self-closing - non concussive

Dimensions: 200 x 1080 x 70

Available in White

**SH01-004** Ceiling height shower tower

**Complimentary accessories:**

**AC17-080** Thermal disinfection valve

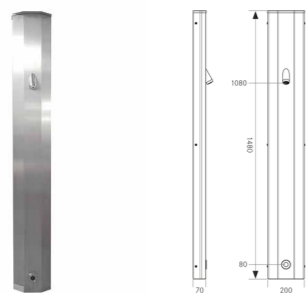

## CEILING HEIGHT SHOWER PROGRAMMABLE SENSOR AND TMV3 - MAINS

Ceiling height shower tower, manufactured from 316 stainless steel with a brushed finish. Suitable for high security applications. Ligature-resistant design with concealed pipework, and in-built TMV3 for high-security applications. Fully programmable using the handheld remote. Functions include adjustable run on times, adjustable range, hygiene purge, lock outs and more.

Built-in TMV3

Sensor operation

Dimensions: 200 x 1080 x 70mm

Available in White

**SH04-061** Shower tower

**Mandatory accessories:**

**AT00-221** Anti-microbial single station kit

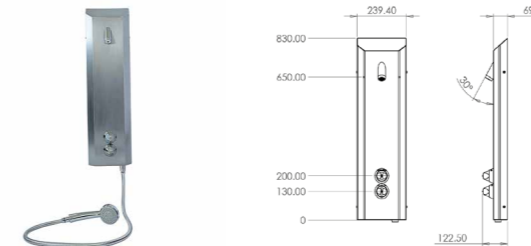

## DUAL OUTLET SHOWER TOWER

Dual outlet shower tower with detachable hose and handset. Manufactured from 316 stainless steel with a brushed finish. Designed with ligature-resistant controls, pre-plumbed pipework and a dual outlet, so that assisted and unassisted showering can be achieved, making it well suited to high security healthcare applications. Switching between outlets is quick and easy due to the inbuilt automatic diverter valve.

TMV3 required on hot water supply

Available in powder coated white upon request

Dimensions: 239 x 930 x 69mm

Available in White

**SH01-013** Dual outlet shower tower

**Mandatory accessories:**

**AC17-047** Thermostatic mixing valve

**Complimentary accessories:**

**AC17-080** Thermal disinfection valve

# Ligature resistant shower gullies

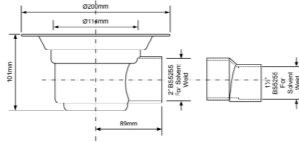

### LIGATURE RESISTANT 50MM WATER SEAL GULLY WITH HORIZONTAL OUTLET FOR SHEET FLOORING

This product is a two-piece gully that features a 50mm water seal, a clamp ring, and a cover plate. The gully has a 2" horizontal outlet and a 2" x 1½" socket reducer. It is designed to be used with concrete and suspended timber floors, and it has a flow rate of 48 litres per minute. The gully is ideal for use in showers and is specifically designed for use with timber floors and floor formers. Additionally, it comes with three cover plate options: white plastic, polished stainless steel, or chrome-plated brass.

TSG50-Anti/Lig

**SW00-110** Ligature resistant 50mm sheet floor gully

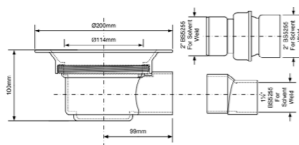

### LIGATURE RESISTANT TWO-PIECE 50MM WATER SEAL GULLY FOR SHEET FLOORING

This is a two-piece gully with a 50mm water seal, clamp ring, and cover plate. It has a 2" horizontal outlet and a 2" x 1½" socket reducer. The product comes with three cover plate options: white plastic, polished stainless steel, or chrome plated brass. It is suitable for concrete and suspended timber floors and has flow rates of 48 litres per minute. The gully is specifically designed for use with timber floors and floor formers and is ideal for showers in various settings.

TSG52-Anti/Lig

**SW00-111** Ligature resistant 50mm 2 part sheet floor gully

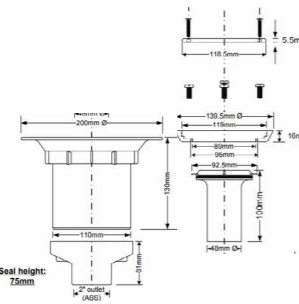

### LIGATURE RESISTANT 75MM WATER SEAL GULLY WITH VERTICAL OUTLET FOR SHEET FLOORING

This is a 75mm water seal trapped gully with a 110mm or 2" vertical solvent spigot outlet. It comes with a clamp ring and a cover plate available in white plastic, polished stainless steel, or chrome plated brass. It is suitable for concrete and suspended timber floors, has an overall height of 130mm, and a flow rate of 48 litres per minute.

TSG2-Anti/Lig

**SW00-113** Ligature resistant 75mm Vertical sheet floor gully

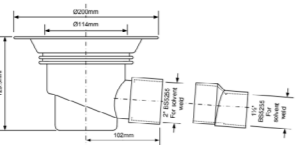

### LIGATURE RESISTANT 75MM WATER SEAL GULLY WITH HORIZONTAL OUTLET FOR SHEET FLOORING

This is a sheet floor gully made of high-quality ABS material. It has a 75mm water seal, a 2" BS EN 1329-1:2020 solvent weld horizontal outlet, and comes with a 2" x 1½" socket reducer. Its flow rate of 48 litres per minute exceeds the minimum requirement of EN 1253-2:2015, and it comes with a choice of white plastic, polished stainless steel, or chrome-plated brass cover plates.

TSG1-Anti/Lig

**SW00-112** Ligature resistant 75mm horizontal sheet floor gully

# NEW Home Office Approved - Ligature Resistant Shower Gully

- Made from Polished Stainless Steel & ABS to the highest quality
- Sheet floor gully suitable for concrete and suspended timber floors
- Flow rates of 48 litres per minute exceed the minimum requirement of EN 1253-2:2015 and are variable dependent on the cover plate used
- Ligature Resistant grating is designed for use in secure accommodation, is Home Office approved and supplied with a security screwdriver bit to release the grating.



## High security shower packs



### DEMENTIA CARE DOC M SHOWER PACK WITH LIGATURE RESISTANT GRAB RAILS

Doc M shower pack in red supplied with: Vita pro lever mixer shower, shower rail and hose, thermal disinfection valve, TMV3 thermostatic mixing valve and grab rail kit.

Grab rail kit includes:

- 1 x ligature-resistant backrest rail 400 x 150mm (RAL 3020)
- 1 x ligature-resistant white backrest cushion
- 2 x ligature-resistant hinge support rail 760 x 250mm (RAL 3020)
- 2 x ligature-resistant straight grab rail 35 x 600mm (RAL 3020)
- 1 x shower seat 650mm (RAL 3020)

**DMPXVT20R**



### HIGH SECURITY LIGATURE RESISTANT DOC M SHOWER PACK

Doc M ligature resistant shower pack in blue supplied with: high security dual outlet shower, thermal disinfection valve, TMV3 thermostatic mixing valve and grab rail kit.

Grab rail kit includes:

- 1 x ligature-resistant backrest rail 400 x 150mm (RAL 5011)
- 1 x ligature-resistant white backrest cushion
- 2 x ligature-resistant hinge support rail 760 x 250mm (RAL 5011)
- 2 x ligature-resistant straight grab rail 35 x 600mm (RAL 5011)
- 1 x shower seat 650mm (RAL 5011)

**DMPXVR13B**



### HIGH SECURITY LIGATURE RESISTANT DOC M SHOWER PACK

Doc M ligature resistant shower pack in White supplied with: high security dual outlet shower, thermal disinfection valve, TMV3 thermostatic mixing valve and grab rail kit.

Grab rail kit includes:

- 1 x ligature-resistant backrest rail 400 x 150mm (RAL 5011)
- 1 x ligature-resistant white backrest cushion
- 2 x ligature-resistant hinge support rail 760 x 250mm (RAL 5011)
- 2 x ligature-resistant straight grab rail 35 x 600mm (RAL 5011)
- 1 x shower seat 650mm (RAL 5011)

**DMPXVR13W**



# Bath filling

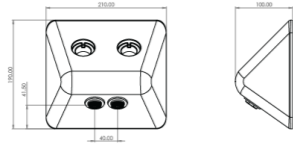

### LIGATURE RESISTANT BATH FILLING MODULE

Safe Ensuite bath module; moulded impact resistant construction, vandal and ligature resistant, suitable for mental healthcare, healthcare and custodial applications.

Separate sensors, control and TMV required  
Dimensions: 210 x 190 x 100mm

**VR01-111** Safe ensuite bath filling module



### HIGH SECURITY ASSISTED BATH SETUP - LIGATURE RESISTANT

Accessible bath pack in stainless steel supplied with: white enameled steel bath, high-security bath filling backplate with hot and cold tactile sensors, bath control system mains operated, anti-microbial valve, thermal disinfection valve, TMV3 thermostatic mixing valve and red grab rails. Manufactured in accordance with HBN 00-10, Part C Standards.

Bath dimensions: 1700 x 700mm

Grab rails include:

3 x ligature-resistant straight grab rail 35 x 600mm (RAL 3020)

**DMPX59R**

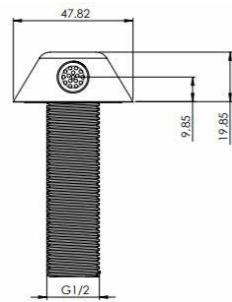

### LIGATURE RESISTANT BATH SPOUT 1/2" BSP

High Security deck mounted Spout. Anti-ligature design. Brushed 316 Stainless Steel finish and DZR Brass BSP connection.

Separate sensors, control and TMV required

**AT07-058** Ligature resistant bath spout



### HIGH SECURITY ASSISTED BATH SETUP - LIGATURE RESISTANT

Accessible bath pack in stainless steel supplied with: white enameled steel bath, high-security bath filling backplate with hot and cold tactile sensors, bath control system mains operated, anti-microbial valve, thermal disinfection valve, TMV3 thermostatic mixing valve and blue grab rails. Manufactured in accordance with HBN 00-10, Part C Standards.

Bath dimensions: 1700 x 700mm

Grab rails include:

3 x ligature-resistant straight grab rail 35 x 600mm (RAL 5011)

**DMPX59B**

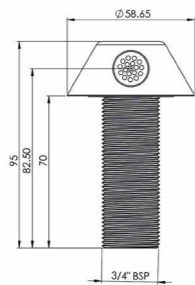

### LIGATURE RESISTANT BATH SPOUT 3/4" BSP

High-security deck mounted spout manufactured in 316 stainless steel with a brushed finish. Designed for mental healthcare and high security environments with fully ligature resistant design, conforming to the safer cell standards and testing. Additional TMV3 required.

DZR Brass BSP connection  
Separate sensors, control and TMV required  
Dimensions: 58 x 25 x 58mm

**AT07-059** Ligature resistant bath spout



### HIGH SECURITY ASSISTED BATH SETUP - LIGATURE RESISTANT

Accessible bath pack in stainless steel supplied with: white enameled steel bath, high-security bath filling backplate with hot and cold tactile sensors, bath control system mains operated, anti-microbial valve, thermal disinfection valve, TMV3 thermostatic mixing valve and white steel grab rails. Manufactured in accordance with HBN 00-10, Part C Standards.

Bath dimensions: 1700 x 700mm

Grab rails include:

3 x ligature-resistant stainless steel straight grab rail 35 x 600mm

**DMPX59W**

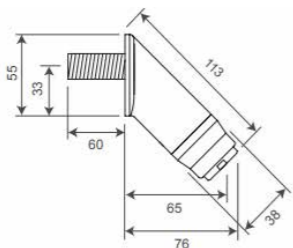

### 45° LIGATURE RESISTANT BATH SPOUT

45° High Security Bath Spout. Ligature-resistant design, complete with unrestricted aerator. Anti-rotation pins. Brushed Stainless Steel finish.

Separate sensors, control and TMV required

**SH07-043** Ligature resistant bath spout



# Safe ensuite sensors and controls

Discover the ultimate in washroom safety by configuring your ideal en-suite solution from our range of advanced control options. We have an array of options to choose from, including the state-of-the-art INFORM system, which provides complete remote control, temperature monitoring and usage data. We also offer standard control boxes that are designed to minimise installation costs while still delivering an intuitive and efficient setup.

These control boxes can be easily customised to suit your unique requirements by selecting appropriate sensors from our extensive collection. With our range of options, you can be assured that your washroom puts patient safety at the forefront of your design. Browse through our pages and select the best control box and sensors that fit your needs and preferences.

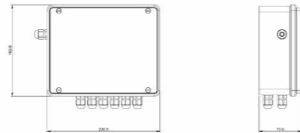

**NEW FOR 2024**

### 6 CHANNEL WASHROOM CONTROL BOX

External control of 1 room couldn't be easier than with the multi-channel control system. The control box has been designed to provide a fully programmable solution tailored to a user's specific needs in all mental healthcare and high security environments. And with the addition of the Key switch, you can isolate the water supply when necessary.

Cost-saving solution, one box controls two ensuites  
5 independent outlets & 1 flush valves  
Control various outlets - basins, taps, showers, baths, and WCs  
Programmed and maintained via the handheld programmer

Dimensions: 250 x 210 x 91mm

**VR07-026** 6 channel washroom control box

**Complimentary accessory:**

**AC01-001** Handheld programmer

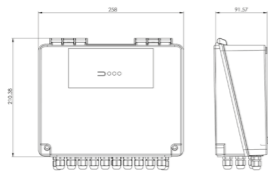

### 12 CHANNEL WASHROOM CONTROL BOX

External control of 2 rooms couldn't be easier than with the multi-channel control system. The control box has been designed to provide a fully programmable solution tailored to a user's specific needs in all mental healthcare and high security environments. And with the addition of the Key switch, you can isolate the water supply when necessary.

Cost-saving solution, one box controls two ensuites  
10 independent outlets & 2 flush valves  
Control various outlets - basins, taps, showers, baths, and WCs  
Programmed and maintained via the handheld programmer

Dimensions: 250 x 210 x 91mm

**VR07-020** 12 channel washroom control box

**Complimentary accessory:**

**AC01-001** Handheld programmer

# Stay in control, stay informed

INFORM Control allows you to understand the behaviour of your water system, remotely implement changes and see the impact in real-time, in comfort from wherever you happen to be.

**NEW**  
**INFORM**  
ENABLED

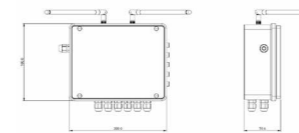

**NEW FOR 2024**

### INFORM 6 CHANNEL CONTROL BOX

Following the established VR07-020 Multi-Channel Control box the Inform 6 Channel Control box gives the option of unprecedented levels of control and enhanced user options including: Remote wireless control of valves, temperature monitoring, remote or on site programming, valve counts, valve opening and closing timestamps, timed hygiene purges and identification of infrequently used outlets. All events are monitored, verified and form part of the extensive range of management information available via the Inform platform 24/7. In addition, user friendly, editable alarms can be set to aid compliance.

In addition INFORM can provide verification that hot taps are  $\geq 50$  °C (55 °C in healthcare premises) and cold taps are below 20 °C within the times required by HSG274 Part 2.

When used with the CMVL8 there are the additional functions of Thermal purges and TMV cold water isolation checks.

Suitable for use with 12 volts sensors

**IC07-006** 6 channel control box

To enable all functions an Inform subscription will be required.

**NEW**  
**INFORM**  
ENABLED

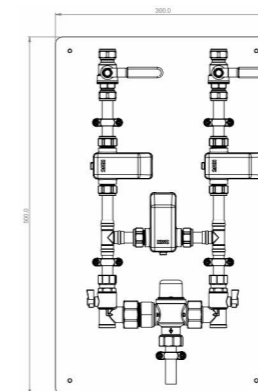

**NEW FOR 2024**

### CMVL8 CONTROL, MONITOR & VERIFY

The CMVL8 is designed to work in conjunction with the Inform enabled Multi Channel control boxes. Complete with full bore 15mm compression isolation valves, check valves, anti-microbial solenoid valves, temperature sensors and a separate thermostatic mixing valve ready for easy installation.

CMVL8 allows you to carry out Thermal purges through both the outlet & TMV and cold water isolation tests without the need to remove IPS panels or manually operate valves. CMVL8 will also provide detailed, reports with date & time, temperatures etc. to ensure you have the information you need to effectively manage the safety of your water system.

In addition INFORM can provide verification that hot taps are  $\geq 50$  °C within one minute (55 °C in healthcare premises) and cold taps are below 20 °C within two minutes of running the cold tap as required by HSG274 Part 2

Dimensions: 254 x 200 x 97mm

**IC07-008** CMVL8 Control, monitor & verify

**Mandatory accessories:**

**IC07-006** INFORM 6 channel control box

**IC07-017** INFORM programmable sensor

# Safe ensuite sensors and controls

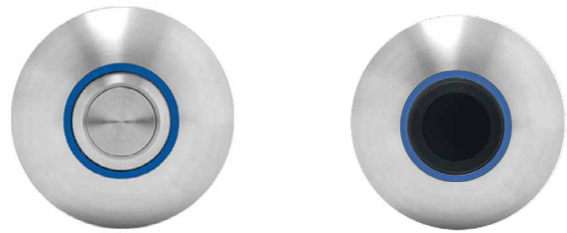

## 12V WC ANTI-VANDAL TACTILE AND WAVE-ON SENSORS

Tactile switch and anti-vandal wave-on sensor manufactured from stainless steel with blue insert. Compatible with a range of KWC DVS products, including; WC flushvalve's, basins and more.

Complete with 15 metre cable  
Thread diameter: Ø21mm (½" BSP)

<b>AC02-043</b>	Blue WC anti-vandal wave-on sensor
<b>AC02-049</b>	Blue WC Tactile switch
<b>WC01-022</b>	WC flushvalve 1 1/2" (1 required per sensor)
<b>WC01-023</b>	WC flushvalve 2" (1 required per sensor)



## 12V WHB WAVE-ON SENSORS

Wave-on sensors manufactured from stainless steel with a brushed finish and temperature indication insert. Capability to adjust settings (control box required).

Complete with 15 metre cable  
Thread diameter: Ø21mm / Ø16.7mm

<b>VR00-003</b>	Blue wave-on sensor (cold) for backplates ONLY
<b>VR00-004</b>	Red wave-on sensor (hot) for backplates ONLY
<b>AC02-043</b>	Blue anti-vandal wave-on sensor (wall mount)
<b>AC02-044</b>	Red anti-vandal wave-on sensor (wall mount)
<b>AC17-101</b>	Solenoid valve (1 required per sensor)

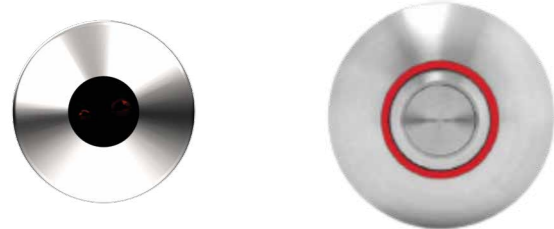

## 12V SHOWER TACTILE AND WAVE-ON SENSORS

Wave-on shower sensor manufactured from stainless steel complete with a 45mm bezel.

Complete with 15 metre cable  
Thread diameter: ½" BSP

<b>SH00-003</b>	Wave-on sensor
<b>AC02-050</b>	Red tactile switch (hot) (wall mount)
<b>AC17-101</b>	Solenoid valve (1 required per sensor)



## 12V WHB TACTILE SWITCHES

Tactile switches, manufactured from stainless steel with a brushed finish and temperature indication insert.

Complete with 15 metre cable  
Thread diameter: Ø21mm (½" BSP)

<b>VR00-007</b>	Blue tactile switch (cold) for backplates ONLY
<b>VR00-008</b>	Red tactile switch (hot) for backplates ONLY
<b>AC02-049</b>	Blue tactile switch (cold) (wall mount)
<b>AC02-050</b>	Red tactile switch (hot) (wall mount)
<b>AC17-101</b>	Solenoid valve (1 required per sensor)



## 12V BATH ANTI-VANDAL TACTILE AND WAVE-ON SENSORS

Anti-vandal wave-on and tactile switches, manufactured from stainless steel with a brushed finish and temperature indication inserts. Suitable for bath filling modules.

Complete with 15 metre cable  
Thread diameter: Ø21mm (½" BSP)

<b>VR00-080</b>	Blue wave-on sensor (cold)
<b>VR00-081</b>	Red wave-on sensor (hot)
<b>VR00-082</b>	Blue tactile switch (cold)
<b>VR00-083</b>	Red tactile switch (hot)
<b>AC17-101</b>	Solenoid valve (1 required per sensor)

For use with VR01-111 backplate only

Choose a control box, key switch and sensor configuration to suit any requirement.

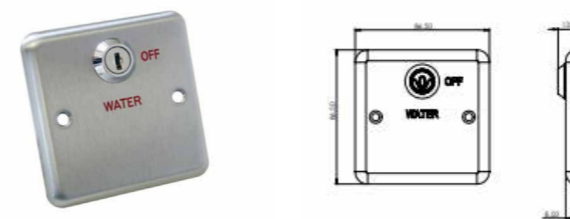

## MULTI-CHANNEL WASHROOM CONTROL BOX - FOR 12V SYSTEM ONLY

External control of 2 rooms couldn't be easier than with the multi-channel control system. The control box has been designed to provide a fully programmable solution tailored to a user's specific needs in all mental healthcare and high security environments. And with the addition of the Key switch, you can isolate the water supply when necessary.

Cost-saving solution, one box controls two ensuites  
10 independent outlets & 2 flush valves  
Control various outlets - basins, taps, showers, baths, and WCs  
Programmed and maintained via the handheld programmer  
Dimensions: 250 x 210 x 91mm

<b>AC04-016</b>	Water control key switch with 8m cable
-----------------	--

The Ultimate solution for high-security environments

# INFORM Custodial Power, Light & Water

INFORM PLW can manage water usage for showers, basins & WCs including delays, run times, recording the number of uses per day, delaying subsequent use and providing lockouts. This is ideal for high security and mental health environments as it will indicate any patterns and behaviours that may cause concern. Water usage can be minimised by combining intelligent and practical limitations of fixture use.

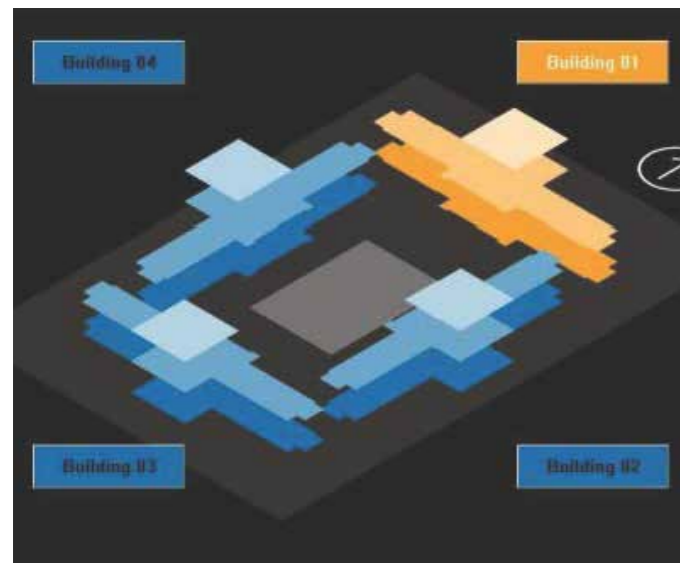

A single control system provides each room with the following features:

- Complete room water fixture control as per INFORM Control
- 230V power sockets - limited to 500 watts
- Up to 2 x room bunk lights
- 1 x main room light with internal/ external switches
- 1 x external check (blue) light switch
- RCBO lighting and power circuit protection
- Low-voltage light switch cables
- Allows staff to isolate power circuits if the occupant has radio or TV outside allowable hours or noise levels
- Reduced cabling requirement, especially if the essential and non-essential design is required
- Ability to reduce consumption to essential power supplies during power failure and re-instate when required

Traditionally, multiple rooms are supplied off the same circuit, and any fault affects multiple rooms. Individual or groups of rooms can be controlled using the INFORM Control dashboard, giving staff the ability to:

- Isolate power
- Isolate lights
- Isolate water
- Extend or remove access rights to TV or radio
- Turn lights off at specific times if required
- Provide immediate isolation of outlets remotely
- Change control settings for WCs, WHBs and Showers
- Monitor individual outlet use
- Data log information, if required
- Remote activation of outlet

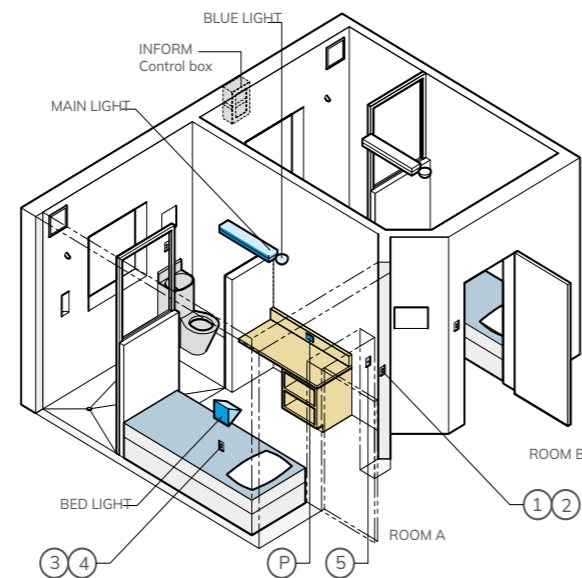

- P 2 x 230V POWER SOCKETS
- 1 EXTERIOR SWITCH MAIN LIGHT
- 2 SWITCH BLUE LIGHT
- 3 SWITCH BED LIGHT 1
- 4 SWITCH BED LIGHT 2
- 5 INTERIOR SWITCH MAIN LIGHT



NEW  
INFORM  
ENABLED

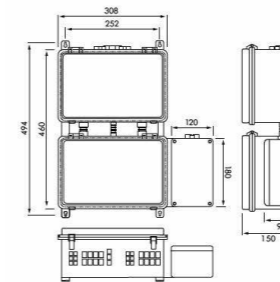

NEW FOR 2024

## INFORM CONTROL - POWER, LIGHT & WATER

INFORM Control provides a remote platform to safely manage power, light and water usage. Shower parameters can be monitored & customised including delays, run times and recording the number of uses per day. This is ideal for high security and mental health environments as it will indicate any patterns and behaviours that may cause concern. WCs can be counted per day, along with delaying subsequent use and providing the option of full and half flushing. Basins can also be controlled similarly to WCs, measuring usage per day, delaying subsequent use and providing lockouts. Water use can be minimised by combining intelligent and practical limitations of fixture use and reliable, proven fixture selection.

**IC07-001** INFORM Control - Power, Light & Water 1 room

**IC07-002** INFORM Control - Power, Light & Water 2 room

### Complimentary accessories:

**IC10-066** INFORM Monitor Universal kit

To enable all functions an Inform subscription will be required. Please choose from a range of our tactile switches.

# Ligature resistant DOC M packs with thermal disinfection



## DOC M PACK BTW BLUE - LIGATURE RESISTANT SENSOR OPERATED WITH THERMAL DISINFECTION

Blue Doc M back to wall ligature-resistant pack supplied with: Ligature resistant GRP WC with blue top, GRP accessible WC spacer box, concealed plastic cistern kit, WC flushvalve kit with programmable sensor, Ligature resistant and short projection washbasin with backplate and cold and hot sensors, Anti-microbial two station mains kit, thermal disinfection valve, TMV3 thermostatic mixing valve.

Grab rail kit includes:

- 1 x ligature-resistant hinged support rail 760 x 250mm (RAL 5011)
- 4 x ligature-resistant straight grab rail 35 x 600mm (RAL 5011)
- 1 x ligature-resistant straight grab rail 35 x 450mm (RAL 5011)
- 1 x ligature-resistant backrest with cushion 35 x 240mm (RAL 5011)

### DMPX30B



## DOC M PACK BTW WHITE - LIGATURE RESISTANT SENSOR OPERATED WITH THERMAL DISINFECTION

White Doc M back to wall ligature-resistant pack supplied with: Ligature resistant GRP WC with blue top, GRP accessible WC spacer box, concealed plastic cistern kit, WC flushvalve kit with programmable sensor, Ligature resistant and short projection washbasin with backplate and cold and hot sensors, Anti-microbial two station mains kit, thermal disinfection valve, TMV3 thermostatic mixing valve.

Grab rail kit includes:

- 1 x ligature-resistant hinged support rail 760 x 250mm
- 4 x ligature-resistant straight grab rail 35 x 600mm
- 1 x ligature-resistant straight grab rail 35 x 450mm
- 1 x ligature-resistant backrest with cushion 35 x 240mm

### DMPX30W



## DOC M PACK BTW RED DEMENTIA CARE - LIGATURE RESISTANT WC & RAILS - MANUAL OPERATION WITH THERMAL PURGE

Red Doc M back to wall pack supplied with: ligature resistant high-security GRP WC with red top, spacer box, cistern, tactile flushvalve kit, Variuscare barrier-free single washbasin with red coloured stripe for the visually impaired, slotted waste, bottle trap, F5L-Therm barrier-free thermostatic single-lever pillar mixer tap, hygiene unit for F5L tap, battery compartment, TMV3 thermostatic mixing valve, and grab rail kit

Ligature resistant grab rail kit includes:

- 1 x ligature-resistant hinged support rail 760 x 250mm (RAL 3020)
- 4 x ligature-resistant straight grab rail 35 x 600mm (RAL 3020)
- 1 x ligature-resistant straight grab rail 35 x 450mm (RAL 3020)
- 1 x ligature-resistant backrest with cushion 35 x 240mm (RAL 3020)

### DMPXF5LHR Left hand

### DMPXF5RHR Right hand

NEW Hygiene unit allows thermal purge override of the manual tap



# Ligature resistant grab rail packs



## LIGATURE RESISTANT BLUE GRAB RAIL PACK

### GRBX803

Grab rail kit includes:

<b>GRBX141BLR</b>	1 x Ligature resistant straight grab rail 35 x 450mm
<b>GRBX161BLR</b>	4 x Ligature resistant straight grab rail 35 x 600mm
<b>GRBX271BLR</b>	1 x Ligature resistant double arm hinged support rail 760 x 250mm
<b>GRBX312B</b>	1 x Blue backrest cushion
<b>GRBX321BLR</b>	1 x backrest rail 400 x 150mm



## LIGATURE RESISTANT WHITE LR GRAB RAIL PACK

### GRBX807

Grab rail kit includes:

<b>GRBX141WLR</b>	1 x Ligature resistant straight grab rail 35 x 450mm
<b>GRBX161WLR</b>	4 x Ligature resistant straight grab rail 35 x 600mm
<b>GRBX271WLR</b>	1 x Ligature resistant double arm hinged support rail 760 x 250mm
<b>GRBX312W</b>	1 x backrest cushion
<b>GRBX321WLR</b>	1 x backrest rail 400 x 150mm



## LIGATURE RESISTANT RED LR GRAB RAIL PACK

### GRBX809

Grab rail kit includes:

<b>GRBX141RLR</b>	1 x Ligature resistant straight grab rail 35 x 450mm
<b>GRBX161RLR</b>	4 x Ligature resistant straight grab rail 35 x 600mm
<b>GRBX271RLR</b>	1 x Ligature resistant double arm hinged support rail 760 x 250mm
<b>GRBX312W</b>	1 x backrest cushion
<b>GRBX321RLR</b>	1 x backrest rail 400 x 150mm



# Ligature resistant accessories

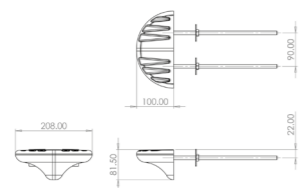

## LIGATURE RESISTANT SOAP DISH

Safe Ensuite soap dish, manufactured from GRP high performance composite material. Designed and tested to be vandal-proof and avoid ligature points wherever possible. The techniques employed to construct these accessories are used very successfully in the field of ballistic armour manufacturing, this results in unrivalled impact resistance. A high-grade non-porous polyester gel coat surface specially formulated to resist chemicals and ultraviolet rays comes as standard.

Dimensions: 208 x 82 x 100mm

**VR01-109** Ligature resistant soap dish

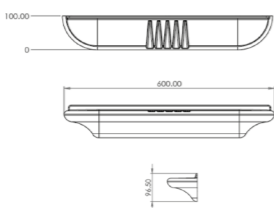

## LIGATURE RESISTANT SHELF

Safe Ensuite shelf, manufactured from GRP high performance composite material. Designed and tested to be vandal-proof and avoid ligature points wherever possible. The techniques employed to construct these accessories are used very successfully in the field of ballistic armour manufacturing, this results in unrivalled impact resistance. A high-grade non-porous polyester gel coat surface specially formulated to resist chemicals and ultraviolet rays comes as standard.

Dimensions: 600 x 96.5 x 100

**VR01-108** Ligature resistant shelf

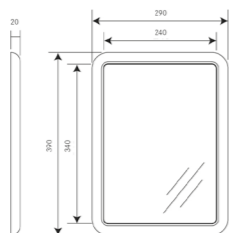

## LIGATURE RESISTANT MIRROR

Safe Ensuite mirror with moulded frame, manufactured from GRP high performance composite material. Designed and tested to be vandal-proof and avoid ligature points wherever possible. The techniques employed to construct these accessories are used very successfully in the field of ballistic armour manufacturing, this results in unrivalled impact resistance. A high-grade non-porous polyester gel coat surface specially formulated to resist chemicals and ultraviolet rays comes as standard.

Dimensions: 290 x 390 x 20

**VR01-025** Ligature resistant mirror

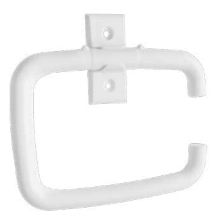

## LIGATURE RESISTANT TOILET ROLL HOLDER

Designed specifically for high security environments, this ligature resistant toilet roll holder features smooth edges, robust hygienic materials and has been tested by SP Technical Research Institute of Sweden.

FEATURES:

- Releases vertical load at a maximum of 20kg
- No sharp corners-Hygienic and chemical resistant

**VR01-055** Ligature resistant toilet roll holder

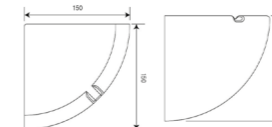

## LIGATURE RESISTANT CORNER SOAP DISH

Safe Ensuite corner soap dish, manufactured from GRP high performance composite material. Designed and tested to be vandal-proof and avoid ligature points wherever possible. The techniques employed to construct these accessories are used very successfully in the field of ballistic armour manufacturing, this results in unrivalled impact resistance. A high-grade non-porous polyester gel coat surface specially formulated to resist chemicals and ultraviolet rays comes as standard.

Pre-drilled steel brackets included

Dimensions: 150 x 50 x 150mm

**VR01-026** Ligature resistant corner soap dish

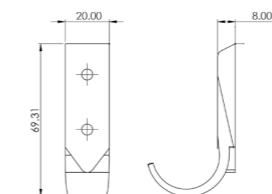

## LIGATURE RESISTANT HOOK

Ligature-resistant hook. Manufactured from. Designed to be wall-mounted and fully ligature-resistant with no sharp corners. The hook has been designed to be durable, not have any loose parts, and is resistant to chemicals. The hook can withstand over 1000 overloads, and will release once the load has reached 20kg.

Dimensions: 20 x 69 x 8mm

**VR01-054** Ligature resistant hook

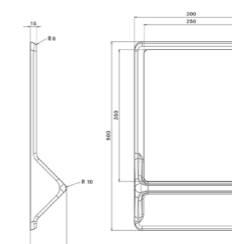

## LIGATURE RESISTANT MIRROR WITH SHELF

Safe Ensuite mirror with moulded frame and shelf, manufactured from GRP high performance composite material. Designed with impact resistant frame & mirror glass and tested to be vandal-proof and avoid ligature points wherever possible. The techniques employed to construct these accessories are used very successfully in the field of ballistic armour manufacturing, this results in unrivalled impact resistance. A high-grade non-porous polyester gel coat surface specially formulated to resist chemicals and ultraviolet rays comes as standard.

Dimensions: 300 x 500 x 16/96mm

**VR01-037** Ligature resistant mirror with shelf



## STEEL VENTILATION GRILL HOUSING

- VR01-059** Steel Ventilation Grill Housing 150mm x 150mm
- VR01-060** Steel Ventilation Grill Housing 200mm x 200mm
- VR01-061** Steel Ventilation Grill Housing 250mm x 250mm
- VR01-062** Steel Ventilation Grill Housing 300mm x 300mm
- VR01-063** Steel Ventilation Grill Housing 350mm x 350mm
- VR01-064** Steel Ventilation Grill Housing 400mm x 400mm
- VR01-065** Steel Ventilation Grill Housing 450mm x 450mm
- VR01-066** Steel Ventilation Grill Housing 500mm x 500mm

# Combination units

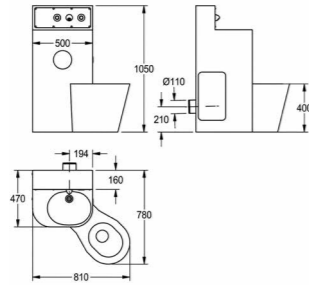

### COMBINATION UNIT WITH RIGHT HAND WC - 500MM BODY

Chromium nickel steel toilet and sink combination unit, satin finish surface, for installing against a wall, with integrated electronic tap components. Invisible fixing with grub screws, lockable inspection opening Mounting stand, material thickness 2mm with elevated rear wall including wall outlet and tactile switch with start/stop function with seamless welded toilet paper roll compartment and seamless moulded wash basin with plastic trap. WC pan, material thickness 1.6mm with full-length skirting, arranged on the right 45 degrees, concealed bowl, tactile switch for WC flushing, flushing certified pursuant to EN 997, horizontal outlet at the back DN 100. With solenoid to connect to premixed hot water or cold water. Condensation water-proof concealed cistern with single flush technology (9 or 6 litres) Supply voltage 24 V DC Including fixing material.

Dimensions: 810 x 1050 x 780mm

**AC04-040**

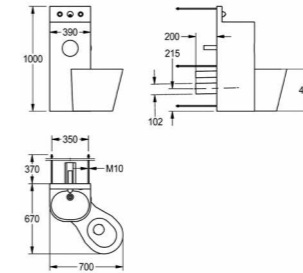

### COMBINATION UNIT WITH RIGHT HAND WC - 390MM BODY

Chromium nickel steel toilet and sink combination unit, satin finish surface, for installing against a wall, with integrated electronic tap components. Invisible fixing with grub screws, lockable inspection opening Mounting stand, material thickness 2mm with elevated rear wall including wall outlet and tactile switch with start/stop function with seamless welded toilet paper roll compartment and seamless moulded wash basin with plastic trap. WC pan, material thickness 1.6mm with full-length skirting, arranged on the right 45 degrees, concealed bowl, tactile switch for WC flushing, flushing certified pursuant to EN 997, horizontal outlet at the back DN 100. With solenoid to connect to premixed hot water or cold water. Condensation water-proof concealed cistern with single flush technology (9 or 6 litres) Supply voltage 24 V DC Including fixing material.

Dimensions 700 x 1000 x 670mm

**AC04-043**

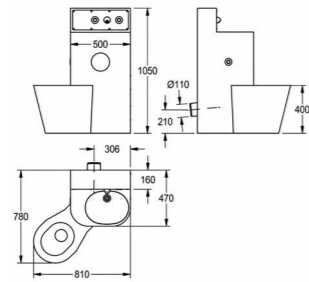

### COMBINATION UNIT WITH LEFT HAND WC - 500MM BODY

Chromium nickel steel toilet and sink combination unit, satin finish surface, for installing against a wall, with integrated electronic tap components. Invisible fixing with grub screws, lockable inspection opening Mounting stand, material thickness 2mm with elevated rear wall including wall outlet and tactile switch with start/stop function with seamless welded toilet paper roll compartment and seamless moulded wash basin with plastic trap. WC pan, material thickness 1.6mm with full-length skirting, arranged on the left 45 degrees, concealed bowl, tactile switch for WC flushing, flushing certified pursuant to EN 997, horizontal outlet at the back DN 100. With solenoid to connect to premixed hot water or cold water. Condensation water-proof concealed cistern with single flush technology (9 or 6 litres) Supply voltage 24 V DC Including fixing material.

Dimensions: 810 x 1050 x 780mm

**AC04-041**

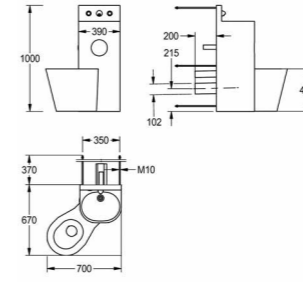

### COMBINATION UNIT WITH LEFT HAND WC - 390MM BODY

Chromium nickel steel toilet and sink combination unit, satin finish surface, for installing against a wall, with integrated electronic tap components. Invisible fixing with grub screws, lockable inspection opening Mounting stand, material thickness 2mm with elevated rear wall including wall outlet and tactile switch with start/stop function with seamless welded toilet paper roll compartment and seamless moulded wash basin with plastic trap. WC pan, material thickness 1.6mm with full-length skirting, arranged on the left 45 degrees, concealed bowl, tactile switch for WC flushing, flushing certified pursuant to EN 997, horizontal outlet at the back DN 100. With solenoid to connect to premixed hot water or cold water. Condensation water-proof concealed cistern with single flush technology (9 or 6 litres) Supply voltage 24 V DC Including fixing material.

Dimensions 700 x 1000 x 670mm

**AC04-044**

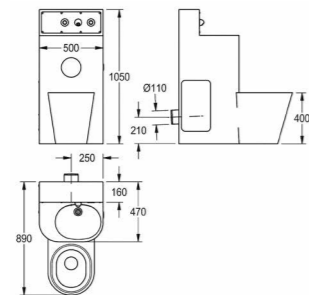

### COMBINATION UNIT WITH CENTRE WC - 500MM BODY

Chromium nickel steel toilet and sink combination unit, satin finish surface, for installing against a wall, with integrated electronic tap components. Invisible fixing with grub screws, lockable inspection opening Mounting stand, material thickness 2mm with elevated rear wall including wall outlet and tactile switch with start/stop function with seamless welded toilet paper roll compartment and seamless moulded wash basin with plastic trap. WC pan, material thickness 1.6mm with full-length skirting, arranged in the middle, concealed bowl, tactile switch for WC flushing, flushing certified pursuant to EN 997, horizontal outlet at the back DN 100. With solenoid to connect to premixed hot water or cold water. Condensation water-proof concealed cistern with single flush technology (9 or 6 litres) Supply voltage 24 V DC Including fixing material.

Dimensions: 500 x 1050 x 780mm

**AC04-042**

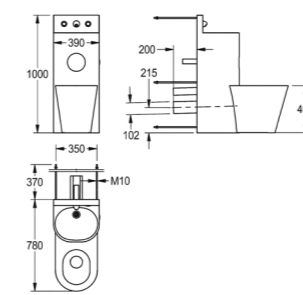

### COMBINATION UNIT WITH CENTRE WC - 390MM BODY

Chromium nickel steel toilet and sink combination unit, satin finish surface, for installing against a wall, with integrated electronic tap components. Invisible fixing with grub screws, lockable inspection opening Mounting stand, material thickness 2mm with elevated rear wall including wall outlet and tactile switch with start/stop function with seamless welded toilet paper roll compartment and seamless moulded wash basin with plastic trap. WC pan, material thickness 1.6mm with full-length skirting, arranged in the middle, concealed bowl, tactile switch for WC flushing, flushing certified pursuant to EN 997, horizontal outlet at the back DN 100. With solenoid to connect to premixed hot water or cold water. Condensation water-proof concealed cistern with single flush technology (9 or 6 litres) Supply voltage 24 V DC Including fixing material.

Dimensions 390 x 1000 x 780mm

**AC04-045**

# High-security accessories

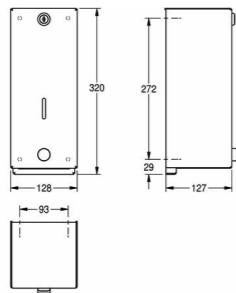

## HEAVY DUTY WALL MOUNTED SOAP DISPENSER

Manufactured from 2mm thick grade 1.4301 (304) stainless steel with a satin polish finish. The casing is held in place by a stainless steel rod fixed to the mounting plate and a security lock. Suitable for liquid soaps and lotions with push button operation and 1 litre tank accessed using the cylinder lock. Fixings included.

Heavy duty liquid soap dispenser  
Capacity: 1 litre liquid soap tank  
Mounting: Wall mounted  
Manual operation  
Dimensions: 128 x 127 x 320mm

**SD300** Wall mounted soap dispenser  
**SO10L** Liquid soap, 10 litres

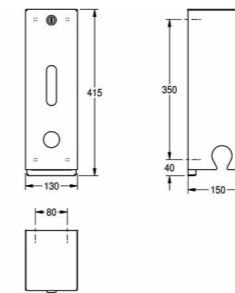

## HEAVY DUTY WALL MOUNTED TOILET ROLL HOLDER

Manufactured from 2mm thick grade 1.4301 (304) stainless steel with a satin polish finish. The casing is held in place by a stainless steel rod fixed to the mounting plate and a security lock. The unit has a tear-off edge, with viewing window for reserve rolls, and comes without spindles. Suitable for rolls with a maximum width of 120mm and maximum diameter 115mm. Fixings included.

Heavy duty toilet roll holder  
Capacity: 3 rolls max. dia. 115mm  
Mounting: Wall mounted  
Dimensions: 150 x 415 x 130mm

**HDTX674** Wall mounted toilet roll holder

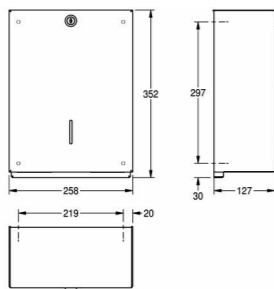

## HEAVY DUTY WALL MOUNTED PAPER TOWEL DISPENSER

Manufactured from 2mm thick grade 1.4301 (304) stainless steel with a satin polish finish. The casing is held in place by a stainless steel rod fixed to the mounting plate and a security lock. Suitable for z fold paper with a loading capacity of 400 - 600 pcs of paper. Fixings included.

Paper towel dispenser  
Capacity: 400 - 600 paper towels  
Mounting: Wall mounted  
Manual operation  
Dimensions: 258 x 127 x 352mm

**TD350** Wall mounted paper towel dispenser

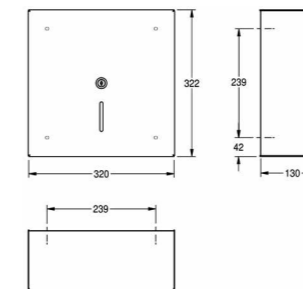

## HEAVY DUTY WALL MOUNTED JUMBO TOILET ROLL HOLDER

Manufactured from 2mm thick grade 1.4301 (304) stainless steel with a satin polish finish. The casing is held in place by a stainless steel rod fixed to the mounting plate and a security lock. Suitable for rolls with a maximum diameter of 300mm the square outer case has an inspection window to the front, and an integrated stainless steel tear-off edges. Fixings are included.

Heavy duty jumbo toilet roll holder  
Capacity: Roll max. dia. 300mm  
Mounting: Wall mounted  
Dimensions: 320 x 130 x 320mm

**RH320** Wall mounted jumbo toilet roll holder

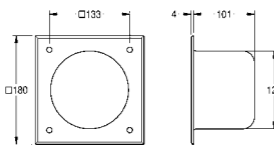

## HEAVY DUTY INSET LIGATURE RESISTANT TOILET ROLL HOLDER

Toilet paper roll compartment for installation in walls, stainless steel, material thickness 2,0 mm, visible surface satin finished. Round insert compartment for one WC paper roll. Mounting from front. With 4 mounting holes, fixing material included.

Dimensions 180 x 180 x 105 mm (W x H x D)

**HDTX673E** Inset ligature resistant toilet roll holder

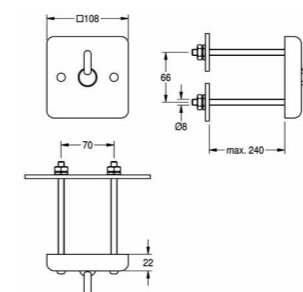

## HEAVY DUTY SECURITY COAT HOOK

Manufactured from 2mm thick grade 1.4301 (304) stainless steel with a satin polish finish. The security hook has a 30mm projection from the back plate and tilts downwards when overloaded.

Security wall hook  
Dimensions: 108 x 108 x 52mm

**HDTX692** Wall mounted from the front  
**HDTX693** Wall mounted from behind with threaded bolts



# High-security accessories

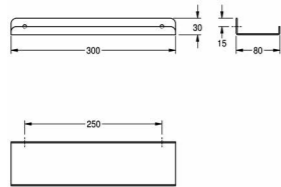

**HEAVY DUTY WALL SHELF**

Manufactured from 2mm thick grade 1.4301 (304) stainless steel with a satin polish finish. The shelf features rounded corners, upturned front edge and fixing holes. Vandal resistant screws are not included.

Heavy duty wall shelf  
Mounting: Wall mounted  
Dimensions: 300 x 80 x 30mm

**AL300HD**

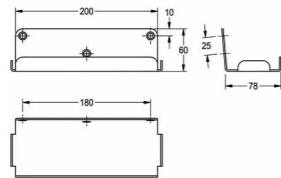

**HEAVY DUTY WALL SHELF**

Manufactured from 2mm thick grade 1.4301 (304) stainless steel with a satin polish finish. The shelf features rounded corners, upturned edges and fixing holes on the rear panel. Fixings included.

Heavy duty wall shelf  
Mounting: Wall mounted  
Dimensions: 83 x 60 x 213mm

**HDTX644**

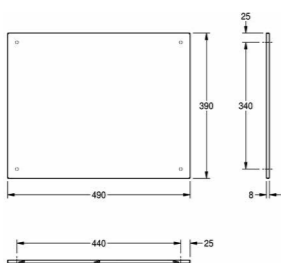

**HEAVY DUTY STAINLESS STEEL WALL MOUNTED MIRROR**

Manufactured from 1mm thick grade 1.4301 (304) stainless steel with a reflective polished surface. The mirror comes with a reinforced polystyrene plate to the rear and hidden thief resistant fixings. Fixings included.

Mounting: Wall mounted

**M500HD** 8 x 490 x 390mm

**M600HD** 8 x 490 x 590mm

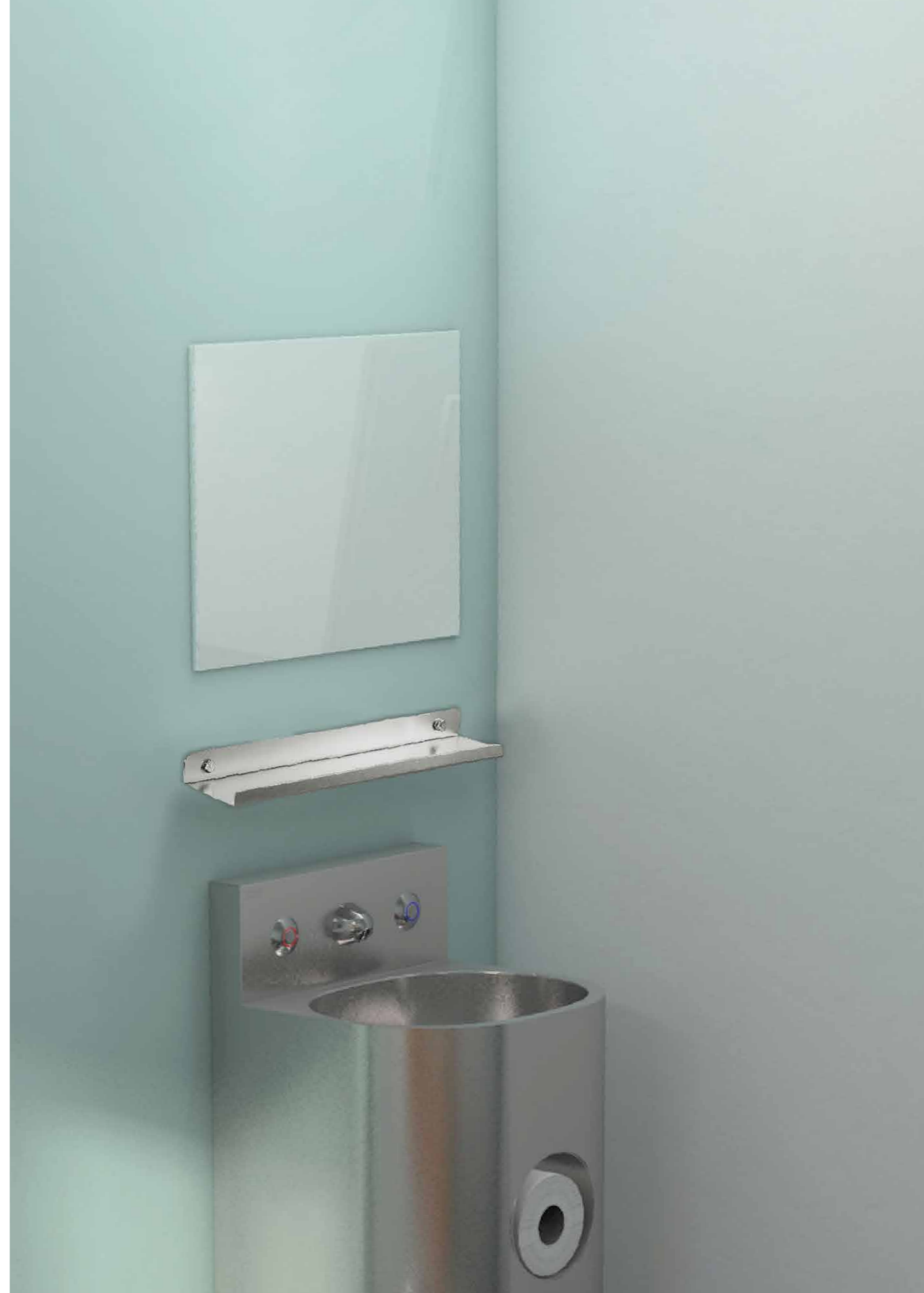



## Catering

Our comprehensive line of commercial catering equipment redefines excellence. Expertly crafted from premium stainless steel, KWC DVS catering products epitomise enduring quality, designed to withstand the test of time.

This extensive range of commercial equipment has been designed to meet the needs of today's leading catering establishments.

# Mini Catering Sinks

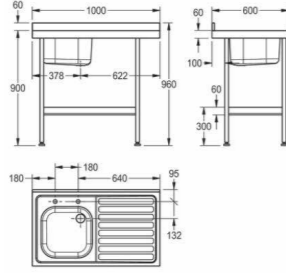

## SISSONS MINI CATERING SINKS - SINGLE BOWL

Mini sinks are manufactured from 1.2mm thick austenitic grade stainless steel polished to a satin finish. Single bowl sinks are all supplied with 38mm waste, plug, chain and overflow. Single bowl sinks have two holes drilled at 180mm centre suitable for either 1mm pillar taps or mixer taps. An earthing lug is fitted under the drainer. Stainless steel under frames complete with shelf are supplied in a flat pack form.

L OR R after the code refers to the handing of the drainer.

External: 1000x600mm  
Bowl: 400x400x250mm

Single Drainer

**E20601L/R** Single Bowl and drainer

### Complimentary accessories:

**K20670N** Stand & shelf for E20601L/R

**F1081N** 13mm crosshead high neck pillar taps OR

**F1083N** 13mm fluted

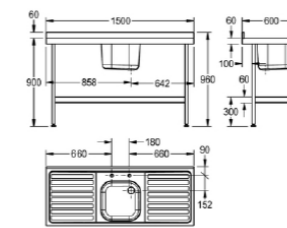

## SISSONS MINI CATERING SINKS - DOUBLE DRAINER

Mini sinks are manufactured from 1.2mm thick austenitic grade stainless steel polished to a satin finish. Single bowl sinks are all supplied with 38mm waste, plug, chain and overflow. Single bowl sinks have two holes drilled at 180mm centre suitable for either 1mm pillar taps or mixer taps. An earthing lug is fitted under the drainer. Stainless steel under frames complete with shelf are supplied in a flat pack form.

L OR R after the code refers to the handing of the drainer.

External: 1500x600mm  
Bowl: 500x400x300mm

Double Drainer

**E20604N** Double drainer

### Complimentary accessories:

**K20672N** Stand & shelf for E20604N

**F1081N** 13mm crosshead high neck pillar taps OR

**F1083N** 13mm fluted

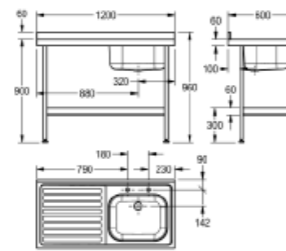

## SISSONS MINI CATERING SINKS - SINGLE BOWL

Mini sinks are manufactured from 1.2mm thick austenitic grade stainless steel polished to a satin finish. Single bowl sinks are all supplied with 38mm waste, plug, chain and overflow. Single bowl sinks have two holes drilled at 180mm centre suitable for either 1mm pillar taps or mixer taps. An earthing lug is fitted under the drainer. Stainless steel under frames complete with shelf are supplied in a flat pack form.

L OR R after the code refers to the handing of the drainer.

External: 1200x600mm  
Bowl: 500x400x250mm

Single Drainer

**E20602L/R** Single Bowl and drainer

### Complimentary accessories:

**K20671N** Stand & shelf for E20602L/R & E20603L/R

**F1081N** 13mm crosshead high neck pillar taps OR

**F1083N** 13mm fluted

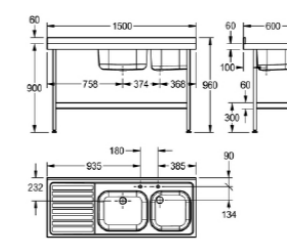

## SISSONS MINI CATERING SINKS 600MM WIDE - DOUBLE BOWL

Mini sinks are manufactured from 1.2mm thick austenitic grade stainless steel polished to a satin finish. The larger bowl is fitted with a 38mm waste, plug, chain and overflow and the smaller outer bowl supplied with a 38mm basket strainer waste outlet. They are both drilled for mixer taps only.

An earthing lug is fitted under the drainer. Stainless steel under frames complete with shelf are supplied in a flat pack form. Each leg is fitted with an adjustable foot with a working height of 900mm.

External: 1500x600mm  
Bowl: 500x400x250mm and 400x400x250mm

Single Drainer

**E20605L/R**

### Complimentary accessories:

**K20672N** Stand & Shelf

**F1026N** 13mm deck pattern mixer tap

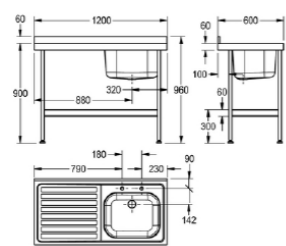

## SISSONS MINI CATERING SINKS - SINGLE BOWL

Mini sinks are manufactured from 1.2mm thick austenitic grade stainless steel polished to a satin finish. Single bowl sinks are all supplied with 38mm waste, plug, chain and overflow. Single bowl sinks have two holes drilled at 180mm centre suitable for either 1mm pillar taps or mixer taps. An earthing lug is fitted under the drainer. Stainless steel under frames complete with shelf are supplied in a flat pack form.

L OR R after the code refers to the handing of the drainer.

External: 1200x600mm  
Bowl: 500x400x300mm

Single Drainer

**E20603L/R** Single Bowl and drainer

### Complimentary accessories:

**K20671N** Stand & shelf for E20602L/R & E20603L/R

**F1081N** 13mm crosshead high neck pillar taps OR

**F1083N** 13mm fluted

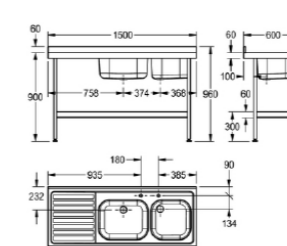

## SISSONS MINI CATERING SINKS 600MM WIDE - DOUBLE BOWL

Mini sinks are manufactured from 1.2mm thick austenitic grade stainless steel polished to a satin finish. The larger bowl is fitted with a 38mm waste, plug, chain and overflow and the smaller outer bowl supplied with a 38mm basket strainer waste outlet. They are both drilled for mixer taps only.

An earthing lug is fitted under the drainer. Stainless steel under frames complete with shelf are supplied in a flat pack form. Each leg is fitted with an adjustable foot with a working height of 900mm.

External: 1500x600mm  
Bowl: 500x400x300mm and 400x400x250mm

Single Drainer

**E20606L/R**

### Complimentary accessories:

**K20672N** Stand & Shelf

**F1026N** 13mm deck pattern mixer tap

# Catering

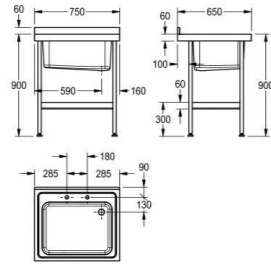

### SISSONS MIDI CATERING SINK 750MM X 650MM

Manufactured from 1.2mm thick, grade 1.4301 (304) stainless steel, with a satin finish. Designed with an earthing lug fitted under the drainer. Stainless steel underframes and shelf (sold separately) are supplied in a flat pack form with easy to read assembly instructions. Each leg is fitted with an adjustable foot (-20, +10mm) with a working height of 900mm. The sink is supplied with 38mm waste and standpipe strainer overflow.

No drainer  
 Tap holes: 2 at 180mm centres  
 Bowl dimensions: 600 x 450 x 300mm  
 Dimensions: 750 x 900 x 650mm

- E20608NP** Complete with underframe
- Complimentary accessories:**
- F1081N** 13mm crosshead pillar taps
- F1083N** 13mm fluted handle pillar taps
- F1026N** 13mm deck pattern mixer tap

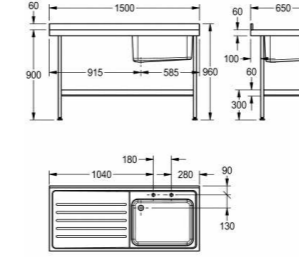

### SISSONS MIDI CATERING SINK 1500MM X 650MM WITH LEFT HAND DRAINER

Manufactured from 1.2mm thick, grade 1.4301 (304) stainless steel, with a satin finish. Designed with an earthing lug fitted under the drainer. Stainless steel underframes and shelf (sold separately) are supplied in a flat pack form with easy to read assembly instructions. Each leg is fitted with an adjustable foot (-20, +10mm) with a working height of 900mm. The sink is supplied with 38mm waste and standpipe strainer overflow.

Drainer: Left hand drainer  
 Tap holes: 2 at 180mm centres  
 Bowl dimensions: 600 x 450 x 300mm  
 Dimensions: 1500 x 900 x 650mm

- E20612LP** Complete with underframe
- E20612LTP** Complete with stand pack and F1083N taps

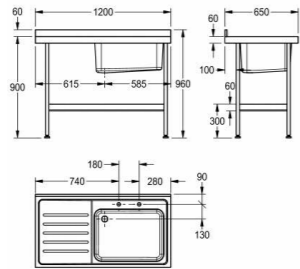

### SISSONS MIDI CATERING SINK 1200MM X 650MM WITH LEFT HAND DRAINER

Manufactured from 1.2mm thick, grade 1.4301 (304) stainless steel, with a satin finish. Designed with an earthing lug fitted under the drainer. Stainless steel underframes and shelf (sold separately) are supplied in a flat pack form with easy to read assembly instructions. Each leg is fitted with an adjustable foot (-20, +10mm) with a working height of 900mm. The sink is supplied with 38mm waste and standpipe strainer overflow.

Drainer: Left hand drainer  
 Tap holes: 2 at 180mm centres  
 Bowl dimensions: 600 x 450 x 300mm  
 Dimensions: 1200 x 900 x 650mm

- E20610LP** Complete with underframe
- E20610LTP** Complete with stand pack and F1083N taps

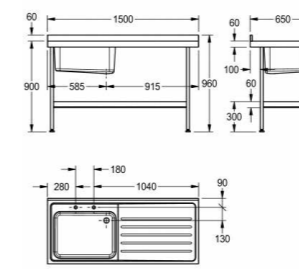

### SISSONS MIDI CATERING SINK 1500MM X 650MM WITH RIGHT HAND DRAINER

Manufactured from 1.2mm thick, grade 1.4301 (304) stainless steel, with a satin finish. Designed with an earthing lug fitted under the drainer. Stainless steel underframes and shelf (sold separately) are supplied in a flat pack form with easy to read assembly instructions. Each leg is fitted with an adjustable foot (-20, +10mm) with a working height of 900mm. The sink is supplied with 38mm waste and standpipe strainer overflow.

Drainer: Right hand drainer  
 Tap holes: 2 at 180mm centres  
 Bowl dimensions: 600 x 450 x 300mm  
 Dimensions: 1500 x 900 x 650mm

- E20612RP** Complete with underframe
- E20612RTP** Complete with stand pack and F1083N taps

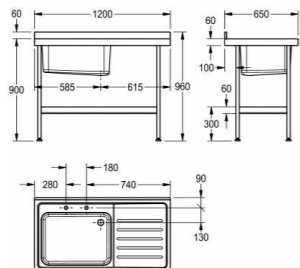

### SISSONS MIDI CATERING SINK 1200MM X 650MM WITH RIGHT HAND DRAINER

Manufactured from 1.2mm thick, grade 1.4301 (304) stainless steel, with a satin finish. Designed with an earthing lug fitted under the drainer. Stainless steel underframes and shelf (sold separately) are supplied in a flat pack form with easy to read assembly instructions. Each leg is fitted with an adjustable foot (-20, +10mm) with a working height of 900mm. The sink is supplied with 38mm waste and standpipe strainer overflow.

Drainer: Right hand drainer  
 Tap holes: 2 at 180mm centres  
 Bowl dimensions: 600 x 450 x 300mm  
 Dimensions: 1200 x 900 x 650mm

- E20610RP** Complete with underframe
- E20610RTP** Complete with stand pack and F1083N taps

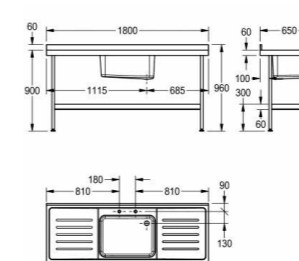

### SISSONS MIDI CATERING SINK 1800MM X 650MM WITH SINGLE BOWL AND DOUBLE DRAINER

Manufactured from 1.2mm thick, grade 1.4301 (304) stainless steel, with a satin finish. Designed with an earthing lug fitted under the drainer. Stainless steel underframes and shelf (sold separately) are supplied in a flat pack form with easy to read assembly instructions. Each leg is fitted with an adjustable foot (-20, +10mm) with a working height of 900mm. The sink is supplied with 38mm waste and standpipe strainer overflow.

Drainer: Double drainer  
 Tap holes: 2 at 180mm centres  
 Bowl dimensions: 600 x 450 x 300mm  
 Dimensions: 1800 x 900 x 650mm

- E20614DP** Complete with underframe
- E20614DTP** Complete with stand pack and F1083N taps

# Catering

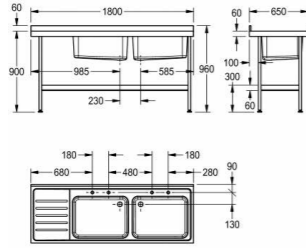

## SISSONS MIDI CATERING SINK 1800MM X 650MM WITH LEFT HAND DRAINER

Manufactured from 1.2mm thick, grade 1.4301 (304) stainless steel, with a satin finish. Designed with an earthing lug fitted under the drainer. Stainless steel underframes and shelf are supplied in a flat pack form with easy to read assembly instructions. Each leg is fitted with an adjustable foot (-20, +10mm) with a working height of 900mm. The sink is supplied with 38mm waste and standpipe strainer overflow.

Drainer: Left hand drainer  
Bowl dimensions: 600 x 450 x 300mm  
Dimensions: 1800 x 650mm

**E20616LP** Complete with underframe  
**E20616LTP** Complete with stand pack and F1083N taps

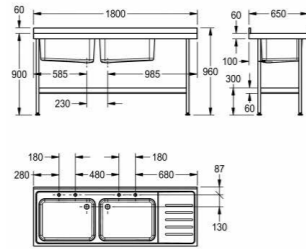

## SISSONS MIDI CATERING SINK 1800MM X 650MM WITH RIGHT HAND DRAINER

Manufactured from 1.2mm thick, grade 1.4301 (304) stainless steel, with a satin finish. Designed with an earthing lug fitted under the drainer. Stainless steel underframes and shelf are supplied in a flat pack form with easy to read assembly instructions. Each leg is fitted with an adjustable foot (-20, +10mm) with a working height of 900mm. The sink is supplied with 38mm waste and standpipe strainer overflow.

Drainer: Right hand drainer  
Bowl dimensions: 600 x 450 x 300mm  
Dimensions: 1800 x 650mm

**E20616RP** Complete with underframe  
**E20616RTP** Complete with stand pack and F1083N taps

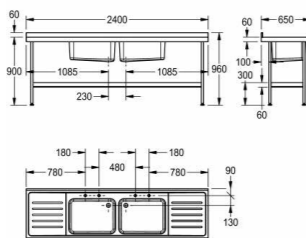

## SISSONS MIDI CATERING SINK 2400MM X 650MM WITH DOUBLE DRAINER

Manufactured from 1.2mm thick, grade 1.4301 (304) stainless steel, with a satin finish. Designed with an earthing lug fitted under the drainer. Stainless steel underframes and shelf (sold separately) are supplied in a flat pack form with easy to read assembly instructions. Each leg is fitted with an adjustable foot (-20, +10mm) with a working height of 900mm. The sink is supplied with 38mm waste and standpipe strainer overflow.

Drainer: Double drainer  
Bowl dimensions: 600 x 450 x 300mm  
Dimensions: 2400 x 650mm

**E20618DP** Complete with underframe  
**E20618DTP** Complete with stand pack and F1083N taps



## OPTIMA ADRIATIC HIGH NECK LEVER TAPS

For connecting to hot and cold water. Manufactured from chromium plated brass.

Mounting: Deck mounted  
Spout projection: 93mm

**F1330N**



## CROSSHEAD PILLAR TAPS

For connecting to hot and cold water. The 13mm basin taps are manufactured from chromium plated brass. Ideal for smaller sinks.

Mounting: Deck mounted  
Spout projection: 75mm

**F1081N**

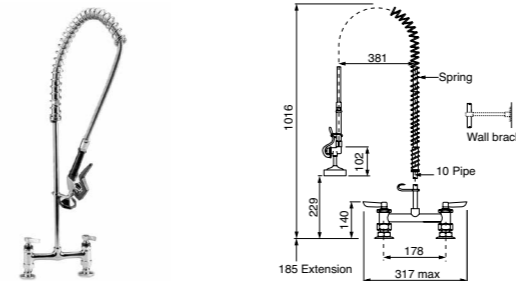

## DECK PATTERN MIXER OVERHEAD SPRAY

For connecting to hot and cold water. The pre-rinse overhead sprays are suitable for those locations where there is a need for a thorough rinsing of utensils and crockery in dish-washing areas. The deck pattern mixer overhead spray is designed for tap hole centres of 180mm. Supplied complete with spray valve and 150mm wall bracket. Suitable for temperatures up to 54°C. Manufactured from chromium plated brass.

Mounting: Deck mounted  
Spout projection: 381mm

**F1062**

# Gastro catering taps

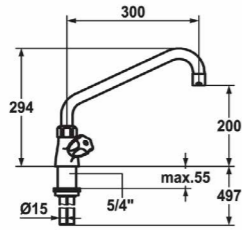

### GASTRO TWO-HANDLE MIXER - COMMERCIAL KITCHEN

This particular faucet model is a two-handle mixer that comes equipped with KWC CORONA metal handles which can be removed if needed. The faucet also features a swivel spout that can rotate 360 degrees, and comes with an adjustable gland and jet regulator. The OptimalSpace design of this faucet provides ample space for washing dishes or performing other kitchen-related tasks. The flat valves of this faucet measure M20 x 1.25 and feature a stainless steel valve seat, while the copper tubes measure  $\varnothing 15$  mm. This faucet can be easily fastened using a threaded sleeve that measures  $1 \frac{1}{4}$ ", and requires a mounting hole size of  $\varnothing 42$  mm.

**100945** Gastro two-handle mixer

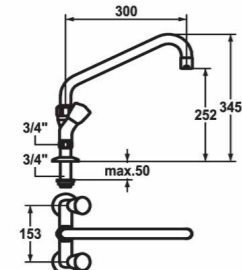

### GASTRO TWO-HANDLE MIXER - COMMERCIAL KITCHEN

This particular faucet features a convenient two-handle mixer design with metal handles that are removable for easy cleaning. The spout is capable of swiveling 360 degrees and comes with an adjustable gland as well as a jet regulator to control water flow. With ample space for washing or working, the OptimalSpace feature ensures you have plenty of room to maneuver. The flat valves are made with durable stainless steel valve seats, and the pillar connections are sized at  $\frac{3}{4}$ " x  $\frac{3}{4}$ " L 45 for secure installation. The mounting hole size is a standard  $\varnothing 28$  mm.

**118411** Gastro two-handle mixer

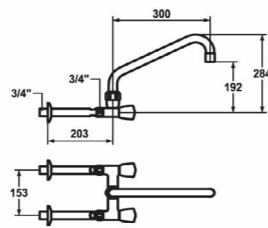

### GASTRO TWO-HANDLE MIXER - COMMERCIAL KITCHEN

This is a description of a two-handle mixer with KWC CORONA metal handles that are removable. The mixer has a swivel spout with an adjustable gland and a jet regulator. It also features OptimalSpace, which provides ample space for washing or working. The flat valves are M20 x 1.25 and the stainless steel valve seat ensures durability. Additionally, the wall connections are  $\frac{3}{4}$ " x  $\frac{3}{4}$ " and there is no shut-off valve, with a total length of 160.

**118404** Gastro two-handle mixer

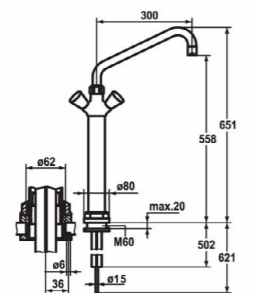

### GASTRO TWO-HANDLE MIXER - COMMERCIAL KITCHEN

This product is a two-handle mixer with a 300mm pillar. It features KWC CORONA metal handles that can be removed, automatic outlet draining, and a preassembled socket. The swivel spout can rotate 360° and has an adjustable gland and jet regulator. The product also has OptimalSpace, which provides ample space for washing or working. The flat valves are M20 x 1.25 and have a stainless steel valve seat. Additionally, the copper tubes are  $\varnothing 15$  mm and the mounting hole size is  $\varnothing 62$  mm.

**100931** Gastro two-handle mixer

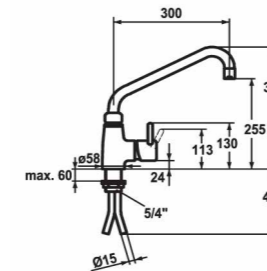

### GASTRO LEVER MIXER - COMMERCIAL KITCHEN

This product is a lever mixer with a swivel spout that can rotate 360°. It comes with an adjustable gland and a jet regulator. The design provides ample space for washing or working, which is called OptimalSpace. The mixer features a KWC cartridge XL 46 with high capacity and ceramic discs. The flow rate and temperature can be continuously adjusted and there is also a temperature limitation feature. The copper tubes have a diameter of 15mm and it is fastened using a threaded sleeve of size  $1 \frac{1}{4}$ ". The mounting hole size is 42mm.

**121267** Gastro lever mixer

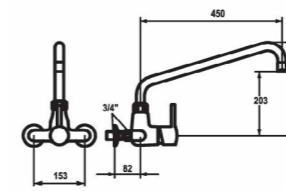

### GASTRO LEVER MIXER - COMMERCIAL KITCHEN

This is a lever mixer with a swivel spout that rotates 360 degrees. It has an adjustable gland and a jet regulator. It has ample space for washing or working, thanks to OptimalSpace. It uses KWC cartridge XL 46 which has ceramic discs and allows for continuous variation of flow rate and temperature. Copper tubes of  $\varnothing 15$  mm are used and it can be fastened using a threaded sleeve of  $1 \frac{1}{4}$ ". It requires a mounting hole of  $\varnothing 42$  mm.

**121290** Gastro lever mixer

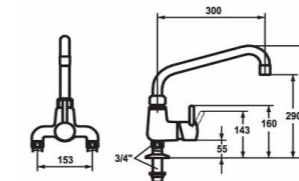

### GASTRO LEVER MIXER - COMMERCIAL KITCHEN

This lever mixer boasts a swivel spout that effortlessly rotates 360 degrees, coupled with an adjustable gland and a jet regulator. With OptimalSpace, there's ample room for washing or working. Its KWC cartridge XL 46 features ceramic discs for a high-capacity and continuous variation of flow rate and temperature, with temperature limitation. Copper tubes of  $\varnothing 15$  mm are used and it can be fastened securely using a threaded sleeve of  $1 \frac{1}{4}$ ". It requires a mounting hole of  $\varnothing 42$  mm.

**121299** Gastro lever mixer

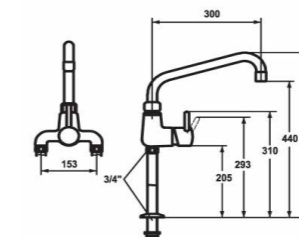

### GASTRO LEVER MIXER - COMMERCIAL KITCHEN

Introducing the Lever Mixer with Swivel Spout that rotates 360° and comes with an adjustable gland and Jet Regulator. It also offers OptimalSpace, which means ample space for washing or working. The mixer uses KWC Cartridge XL 46 that has high capacity, ceramic discs, and allows for continuous flow rate and temperature adjustment. The temperature is also limited for safety purposes. The Pillar Connections are  $\frac{3}{4}$ " x  $\frac{3}{4}$ " L 195, and the mounting hole size is  $\varnothing 30$  mm.

**121301** Gastro lever mixer

# Gastro catering taps

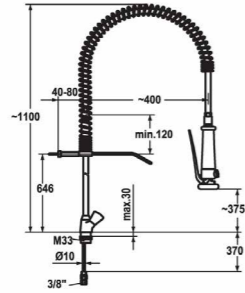

### GASTRO TWO-HANDLE MIXER - COMMERCIAL KITCHEN

This is a two-handle mixer faucet with a suspension spring. It comes with KWC CORONA metal handles, TouchProtect anti-scald technology, and is intrinsically safe against backflow. The faucet has a pre-rinse spray with a delayed closing device and valve maintenance unit. It also has SprayClean, SprayLock, and PowerClean features. The faucet is designed to provide ample space for washing or working, has flat valves M20 x 1.25, stainless steel valve seat, and copper tubes ø10 mm. It can be mounted using the threaded sleeve M33 x 1.5 and requires a mounting hole size ø35 mm.

100962 Gastro two-handle mixer

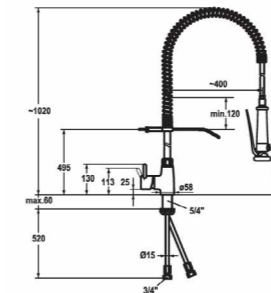

### GASTRO LEVER MIXER - COMMERCIAL KITCHEN

This text describes a lever mixer with a suspension spring that features touchProtect anti-scald protection and is intrinsically safe against backflow. The mixer also includes a pre-rinse spray with a delayed closing device to minimize water hammer, a valve maintenance unit, SprayClean technology, SprayLock, PowerClean, and OptimalSpace. The mixer is equipped with a KWC cartridge XL 46, copper tubes ø15 mm, and requires a threaded sleeve 1 ¼" for fastening. The mounting hole size is ø42 mm.

121273 Gastro lever mixer

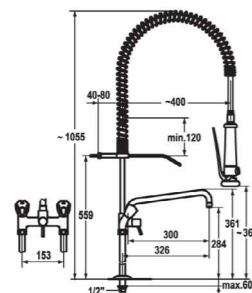

### GASTRO TWO-HANDLE MIXER - COMMERCIAL KITCHEN

This is a two-handle mixer with a suspension spring that comes with KWC CORONA metal handles. It has TouchProtect to prevent scalding, is intrinsically safe against backflow, and has a 180° swivel spout. The pre-rinse spray minimizes water hammer, and SprayClean prevents limescale buildup. SprayLock allows you to lock the spray in place, while PowerClean provides more focused cleaning power. The product has OptimalSpace, flat valves made from stainless steel, ½" x ¾" L 130 pillar connections, and a ø22 mm mounting hole size.

122254 Gastro two-handle mixer

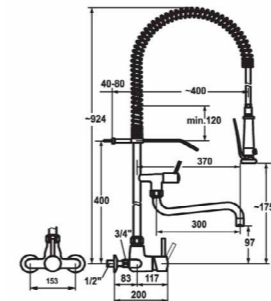

### GASTRO LEVER MIXER - COMMERCIAL KITCHEN

The faucet has a lever mixer, suspension spring, and TouchProtect anti-scald protection. It's intrinsically safe against backflow and has a swivel spout that rotates up to 160 degrees. The pre-rinse spray minimizes water hammer and there's a valve maintenance unit for cleaning. The OptimalSpace design provides ample space for washing or working. The KWC cartridge XL 46 ensures a high capacity with ceramic discs for a smooth and continuous water flow.

121284 Gastro lever mixer

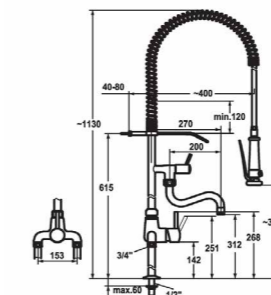

### GASTRO LEVER MIXER - COMMERCIAL KITCHEN

The product is safe and prevents backflow. It has a swivel spout with adjustable gland, jet regulator, and pre-rinse spray with delayed closing device to reduce water hammer. It's easy to clean with SprayClean and has a lockable jet spray, SprayLock. PowerClean is a needle spray mode for better cleaning. It provides ample space for washing or working and has a high-capacity KWC cartridge XL 46 and ceramic discs. Temperature and flow rate are variable, and it mounts with pillar connections ½" x ¾" L 130 and ø22 mm hole.

121294 Gastro lever mixer

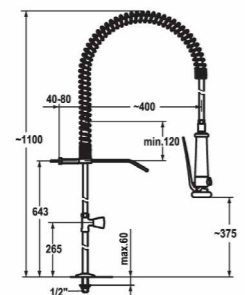

### GASTRO TWO-HANDLE MIXER - COMMERCIAL KITCHEN

The faucet has a vertical shut-off valve and suspension spring for easy operation and stability. The KWC CORONA metal handle is removable (cold water). TouchProtect and pre-rinse spray ensure safety, while SprayClean prevents limescale buildup. SprayLock and PowerClean make cleaning easy. The OptimalSpace design provides ample washing space. The faucet has flat valves M20 x 1.25, a stainless steel valve seat, ½" connecting thread, and ø22 mm mounting hole.

100960 Gastro two-handle mixer

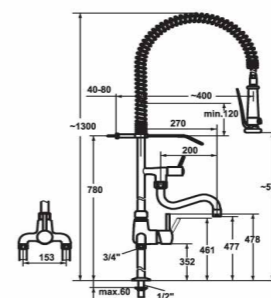

### GASTRO LEVER MIXER - COMMERCIAL KITCHEN

Introducing the Lever Mixer with Swivel Spout that rotates 360° and comes with an adjustable gland and Jet Regulator. It also offers OptimalSpace, which means ample space for washing or working. The mixer uses KWC Cartridge XL 46 that has high capacity, ceramic discs, and allows for continuous flow rate and temperature adjustment. The temperature is also limited for safety purposes. The Pillar Connections are ¾" x ¾" L 195, and the mounting hole size is ø30 mm.

121296 Gastro lever mixer

121297 Gastro lever mixer

KWC DVS washrooms

# Gastro E Stainless-steel catering taps

Always a class ahead

**KWC GASTRO E** - the stainless-steel solution for the catering industry  
 In professional kitchens, the KWC GASTRO line is in a class of its own. The KWC GASTRO is now available in pure stainless steel. It is, therefore, even more, durable and ensures a virtually unprecedented hygiene level. Stainless steel is also the perfect fit for a professional kitchen. The KWC GASTRO line features a comprehensive range of products, with elements that can be combined and expanded upon in line with individual requirements. Highlights include the extremely robust pre-rinse spray.



**LEVER MIXER  
 SWIVEL SPOUT, A300**

Z.539.000.700 stainless steel



**LEVER MIXER  
 SWIVEL SPOUT, A 450**

Z.539.001.700 stainless steel



**EXTENSION SOCKET 100MM**

Z.539.000.700, stainless steel



**EXTENSION SOCKET 300MM**

Z.539.001.700 stainless steel



**LEVER MIXER  
 PRE-RINSE SPRAY, A200,  
 WITH SPOUT**

Z.539.030.145, stainless steel



**LEVER MIXER  
 PRE-RINSE SPRAY, A300,  
 WITH SPOUT**

Z.539.030.145, stainless steel



**PRE-RINSE SPRAY,  
 SWIVELLING**

Z.539.030.145, graphite grey



**High-quality materials**

Stainless steel is easy to clean and does not provide a breeding ground for bacteria. Stainless steel's sustainability is down to its long-lasting nature and complete recyclability. It also leaches less heavy metal than other materials.

**High flow rate**

Thanks to the high-performance cartridge, the KWC GASTRO E stands out with its extraordinarily high flow rate. The 360-degree swivel range is the ultimate addition to the user-friendly design.

**Optimal space utilisation**

The two different base lengths mean that the tap height can be adjusted in line with individual requirements. The flexible connection hoses make installation quick and easy.

**Simple maintenance**

The lockable pre-rinse spray features delayed closing for pressure shock damping, and a valve-maintenance unit for cleaning. This ensures that the tap can be reliably maintained, which in turn helps increase its service life.





**KWC**

KWC DVS washrooms

## Bistro E Catering taps

### The best of both worlds

**KWC BISTRO E** - professional quality for small professional operations and exclusive kitchens in stainless steel

With the KWC BISTRO E, functionality and effectiveness are paramount. The pre-rinse spray model has a stainless-steel spray head with two types of streams and ergonomic grips. The KWC BISTRO E also does well in consumption and helps save both water and energy. The entire line is characterised by professional efficiency and technology. Combined with a high cleaning performance and ease of use, it meets even the most demanding requirements.

#### **Stainless steel for optimal sustainability**

High-quality stainless steel is robust and easy to clean. It guarantees the taps' longevity, a high hygiene level and less heavy metal leaching than other materials. It therefore proves its reliability over the long term.

#### **Efficient technology**

The pre-rinse spray with two types of streams helps to save water while providing an improved cleaning performance. The centred cleaning stream is perfect for gentle washing.

#### **Versatile application options**

The slimline design is simple, elegant and space-saving. The KWC BISTRO E is therefore suitable for both smaller professional kitchens and private homes.

#### **Enjoyable operation**

The patented HighFlex technology and the stainlesssteel support spring extend the radius of motion around the sink for convenience at all times.



**LEVER MIXER SWIVEL SPOUT, A250**

10.581.013.700FL, stainless steel



**LEVER MIXER HIGH FLEX, A235**

10.581.433.700FL, stainless steel



**LEVER MIXER PRE-RINSE SPRAY, A295 WITH SPOUT**

10.581.144.700FL, stainless steel

# F5 Intelligent kitchen taps

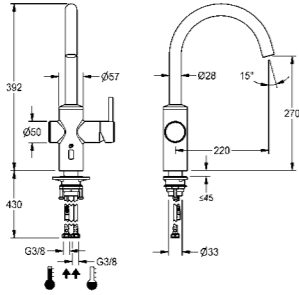

### F5LME HYBRID KITCHEN TAP

F5LME hybrid kitchen fitting DN 15 as pillar mixer with swivelling spout, can be locked in the centre position. Adjustable swivel ranges of 50°, 120° and 360°. For connection to hot water and cold water via hoses with strainers. Single lever mixer with mixer cartridge with ceramic disc technology and adjustable, turn-proof temperature stop. Alternative activation using hand reflection via an opto-electronic sensor for time-controlled water release with preset mixing water temperature. Mixer cartridge, solenoid valve and sensor with control electronics in all-metal housing, brushed stainless steel.

Laminar jet controller with integrated flow rate controller (8.0 l/min). Projection 220mm. Activated water hygiene flushing 24 hours after last activation, safety switch-off for continuous reflection and saving of statistical data. If you require additional functionality, such as sensor range adjustment and tap run time, a bi-directional remote is available as an extra. Battery compartment including battery or power supply unit with extension cable must be ordered separately.

**F5LME001** F5LME tap

**Mandatory accessories;**

**ACEX9023** Battery compartment

**Complimentary accessories;**

**SD01-003** Pillar automatic soap dispenser

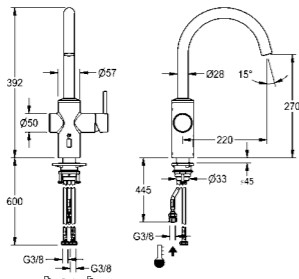

### F5LME HYBRID KITCHEN TAP FOR HOT WATER HEATER

F5LME hybrid kitchen fitting DN 15 as pillar mixer with swivelling spout, can be locked in the centre position. Adjustable swivel ranges of 50°, 120° and 360°. To the connection via hoses in open undercounter boilers. Single lever mixer with mixer cartridge with ceramic disc technology and adjustable, turn-proof temperature stop. Alternative activation using hand reflection via an opto-electronic sensor for time-controlled water release with preset mixing water temperature. Mixer cartridge, solenoid valve and sensor with control electronics in all-metal housing, brushed stainless steel. With beam shaper. Projection 220mm. Activated water hygiene flushing 24 hours after last activation, safety switch-off for continuous reflection and saving of statistical data. If you require additional functionality, such as sensor range adjustment and tap run time, a bi-directional remote is available as an extra. Battery compartment including battery or power supply unit with extension cable must be ordered separately.

Water heater not included.

**F5LME002** F5LME tap

**Mandatory accessories;**

**ACEX9023** Battery compartment

**Complimentary accessories;**

**SD01-003** Pillar automatic soap dispenser



## KWC F5 – the new hybrid kitchen tap

The efficient use of water and energy helps optimise operating costs in office and administration buildings. Electronic taps are now standard in the washrooms of these buildings. At the same time, they help ensure drinking water hygiene. Most tea and coffee kitchens in offices, however, still have conventional, lever-operated kitchen taps. The new F5 hybrid kitchen tap from KWC Professional combines the advantages of an electronic tap with the ease of use of a lever mixer.



## Drinking fountains

Quenching thirst sustainably, KWC DVS presents a versatile range of drinking fountains, a common sight in leisure hubs, offices, schools and other commercial facilities. Tailored to diverse applications, our collection includes wall-mounted or floor-standing units, with or without bottle fillers and even chilled options. Crafted from robust stainless steel, these fountains are a testament to durability and ease of installation.

In an era where bottled water consumption has doubled in the last 15 years, we offer an eco-conscious solution. Nearly half of plastic bottle waste originates from bottled water, but our range provides the perfect antidote. Studies indicate that incorporating more free drinking water taps and fountains in public spaces could slash plastic bottle usage by a remarkable 65%. By making rehydration convenient and sustainable, our fountains inspire individuals to choose reusable bottles over plastic waste. Let's transform hydration habits while embracing durability, accessibility, and environmental responsibility.

# Drinking fountains and bottle fillers

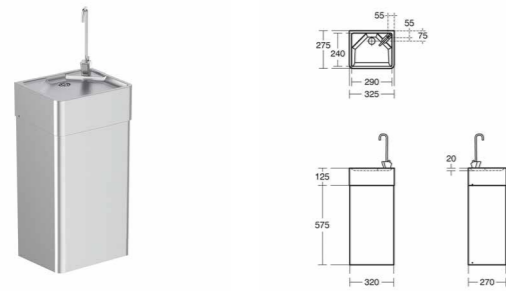

### SISSONS BOTTLE FILLER 700MM

Junior height (700mm) floor mounted pedestal drinking fountain manufactured from stainless steel with a brushed finish. Designed with self closing valve with protected nozzle to minimise direct contact, complete with bottle filler.

Tamper resistant pedestal  
Adult height 700mm  
Supplied with bottle Filler

**ANMX70** Bottle filler 700mm

BUILD YOUR OWN

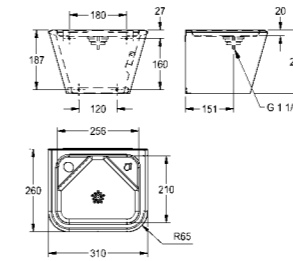

### ANIMA WALL MOUNTED DRINKING FOUNTAIN

ANIMA wall-mounted drinking fountain, stainless steel, satin finished surface, material thickness 1.2mm, seamlessly integrated flat bowl without overflow, rectangular drinking fountain shape with rounded edges, two tap holes including cover, strainer waste G 1 1/4 B, including mounting material.

Dimensions 310 x 200 x 260mm  
Bowl dimensions 256 x 20 x 210mm  
Drinking fountain tap and/or bottle filler tap sold separately

- ANMX30U** Drinking fountain
- ANMX-S1** ANIMA pedestal
- ANMX-BU** Self-closing drinking bubbler
- ANMX-BT** Bottle filler tap
- F6001** Tap hole stopper

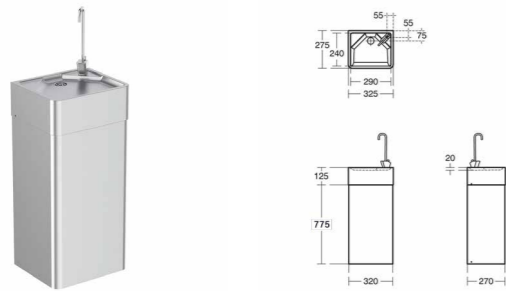

### SISSONS BOTTLE FILLER 900MM

Adult height (900mm) floor mounted pedestal drinking fountain manufactured from stainless steel with a brushed finish. Designed with self closing valve with protected nozzle to minimise direct contact, complete with bottle filler.

Tamper resistant pedestal  
Adult height 900mm  
Supplied with bottle Filler

**ANMX90** Bottle filler 900mm

BUILD YOUR OWN

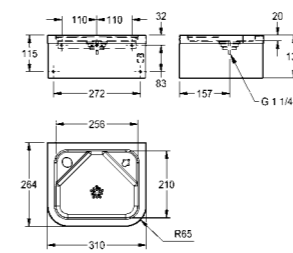

### ANIMA WALL MOUNTED DRINKING FOUNTAIN

ANIMA wall-mounted drinking fountain, stainless steel, satin finished surface, material thickness 1.2mm, seamlessly integrated flat bowl without overflow, rectangular drinking fountain shape with rounded edges, two tap holes including cover, circumferential apron with material thickness 1mm, strainer waste G 1 1/4 B, including mounting material.

Dimensions 310 x 135 x 264mm  
Bowl dimensions 256 x 20 x 210mm  
Drinking fountain tap and/or bottle filler tap sold separately

- ANMX21ES** Drinking fountain
- ANMX-S3** ANIMA pedestal
- ANMX-BU** Self-closing drinking bubbler
- ANMX-BT** Bottle filler tap
- F6001** Tap hole stopper

246

BUILD YOUR OWN

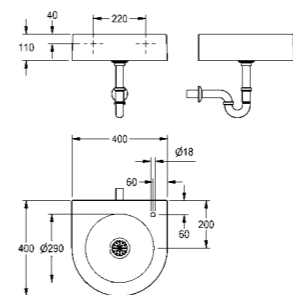

### ANIMA WALL-MOUNTED DRINKING FOUNTAIN

Wall-mounted drinking fountain made of MIRANIT resin-bonded-mineral material with pore-free smooth surface (temperature-resistant up to 80 °C), Alpine white colour. With seamlessly moulded round bowl, without overflow, with tap hole 18 mm (D) on the right. Mounted via back panel. Circumference of apron 110 mm (H). With strainer waste G 1 1/4 B, siphon G 1 1/4 B, including mounting materials.

Dimensions 400 x 110 x 400 mm (W x H x D)  
Bowl dimensions 290 x 75 mm (D x H)

- SIRW24D** Drinking fountain
- ANMX-BU** Self-closing drinking bubbler
- ANMX-BT** Bottle filler tap

# Chilled drinking fountains

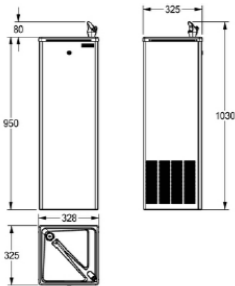

**CHILLED DRINKING FOUNTAIN**

Water Gem water coolers and drinking fountains by KWC DVS offer a reliable solution for commercial buildings requiring chilled drinking water. Available as floor-standing or wall-mounted models, they are directly connected to the mains water supply providing an unlimited amount of fresh-tasting chilled water. Made from durable coated steel panels with an easy-to-open front panel for installation and maintenance. These products come with a standard chlorine-based water filter that should be replaced every six months.

**ANMX308** Chilled drinking fountain

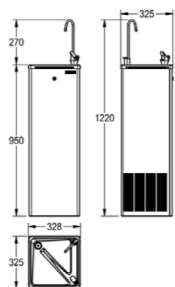

**CHILLED DRINKING FOUNTAIN**

Water Gem from KWC DVS offers low-maintenance water coolers and fountains for commercial buildings. These products supply unlimited chilled drinking water, come in various mount options, and have a durable, easy-to-maintain design. They also feature a standard chlorine-based filter, which should be replaced every six months.

**ANMX309** Chilled drinking fountain

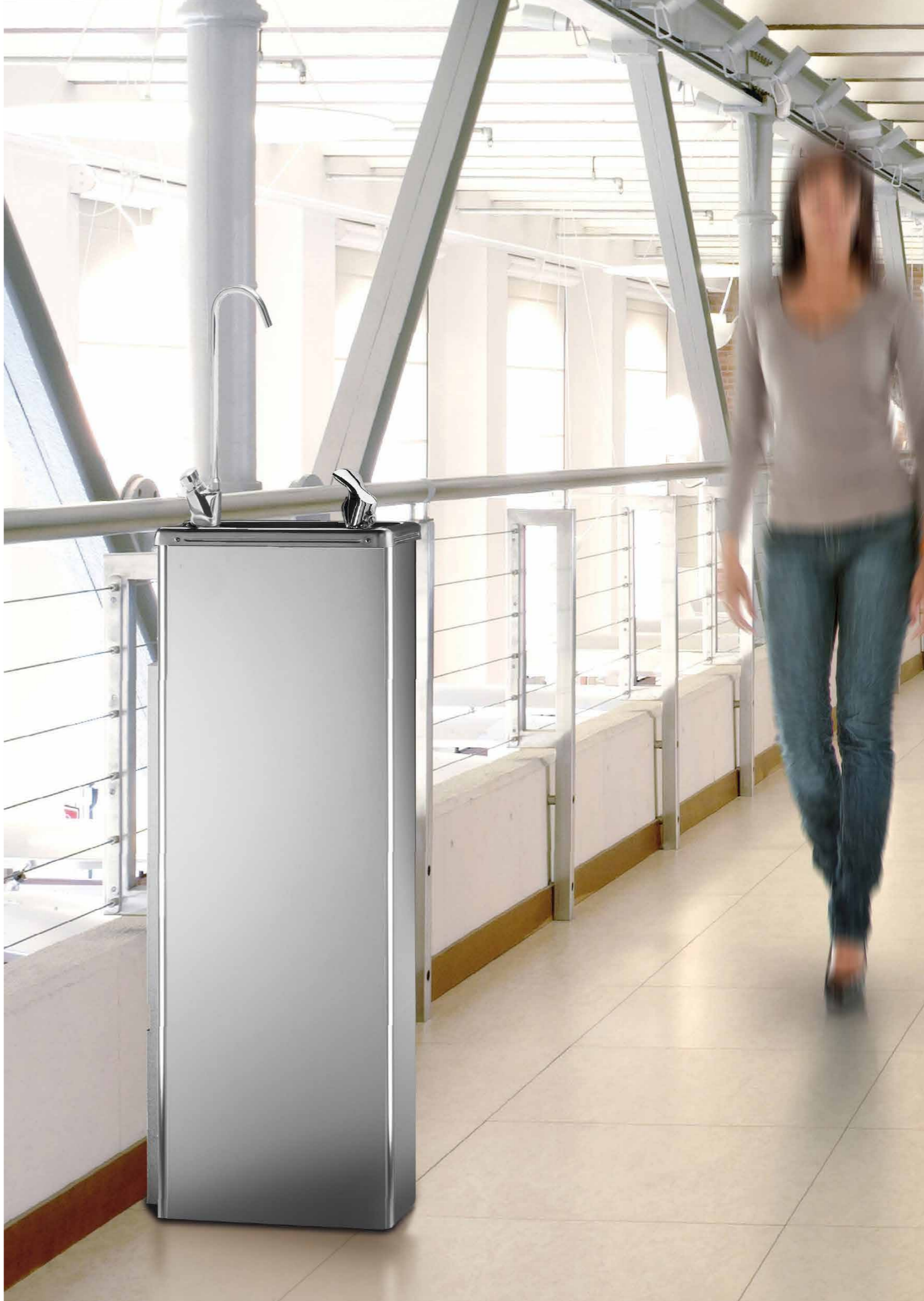

# KWC DVS

Professional

To find out more  
information about our  
washroom solutions  
visit our website



KWC DVS | North: 01246 458900 | South: 01803 529021  
[kwcdvssales@kwc.com](mailto:kwcdvssales@kwc.com) | [www.dartvalley.co.uk](http://www.dartvalley.co.uk)