

F5S Therm MIRANIT shower panel

MODEL RANGE: F5 | F5ST2027 | 210.0595.587

Showers | Self closing showers

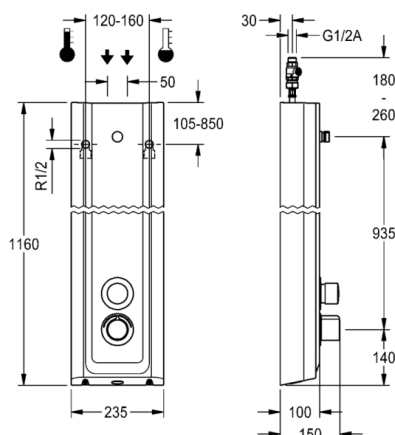

F5S Therm shower panel made of mineral material for wall mounting with DN 15 self-closing thermostatic mixer and connecting nozzles for the shower head. Hydraulically controlled, for connection to hot water and cold water. Shower valve with integrated FRAMIC self-closing cartridge, thermostat and mechanism for an optional water hygiene unit for automatic water hygiene flushing, program-controlled thermal disinfection (additional bypass solenoid-operated flush valve cartridge required) and storage of statistical data. FRAMIC self-closing cartridge, low maintenance and stagnation free, with ceramic disc technology, self closing, flow pressure independent due to the medium-independent design. Stepless adjustment of flow duration. Thermostat with metal handle, an adjustable and turn-proof temperature stop and an option for manual thermal disinfection. All-metal construction, visible parts high-polished or chrome-plated. Connecting nozzles for the required additional DN 15 Franke shower head with pre-fitted flow regulator 9.0 l/min. Housing with raised function surface made of MIRANIT resin-bonded mineral material with pore-free smooth surface (temperature-resistant up to 80 °C), Alpine white colour. Connecting hoses with lockable water volume control with backflow preventer and strainer.

Dimensions of housing 235 x 1160 x 100 mm (W x H x D)

Shower head to be ordered separately.

Technical data	
Overall depth	100.00 mm
Overall height	1,160.00 mm
Overall width	235.00 mm
Tailor made	No
Type of mounting	Wall mounting
Type of operation	Manual operation
Diameter nominal	DN 15
Inlet size	G-1-2-A
Material casing	Mineral material
Material fitting	Brass
Type of mixing	Thermostat
Sound insulation	No
Surface finish fitting	Chromed
Minimum flow pressure	1.50 bar
Volume flow rate at 3 bar	0.15 liter per second
Adjustable flow time	Yes
Functional principle	Hydraulic self-closing
Protective shutdown	No
Thermal disinfection	Prepared for automatic thermal disinfection
Additional connections	No
Circulation	No
Connection with pay water dispenser	Not possible
Shower pipe draining	No
Type of shower	Shower panel
Position of water connection	From top / backside
Material code casing	MIRANIT
Maximum flow time	35.00 seconds
Minimum flow time	5.00 seconds



F5S Therm MIRANIT shower panel

MODEL RANGE: F5 | F5ST2027 | 210.0595.587

Showers | Self closing showers

Accessory Mandatory



AQUAJET-Slimline shower head for F5 shower panels

2030054255

SHAS0011



AQUAJET-Comfort shower head for F5 shower panels

2030054254

SHAC0011



MÜNCHEN shower head for F5 shower panels

2030054793

SHMU0011

Accessory Optional

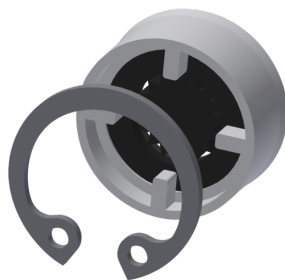

Flow controller 12,0 l/min

2000104783

ESHHE0002



Hygiene unit for F5S Therm shower panel

2030057064

ACST2004



Housing extension for F5 shower panels made of MIRANIT

2030057071

ACXX2016



Housing extension for F5 shower panels made of MIRANIT

2030057072

ACXX2017



Housing extension for F5 shower panels made of MIRANIT

2030057073

ACXX2018



Housing extension for F5 shower panels made of MIRANIT

2030057075

ACXX2019



Housing extension for F5 shower panels made of MIRANIT

2030057076

ACXX2020



Connection adapter

2000101441

AQRM928

F5S Therm MIRANIT shower panel

MODEL RANGE: F5 | F5ST2027 | 210.0595.587

Showers | Self closing showers

Spare Parts

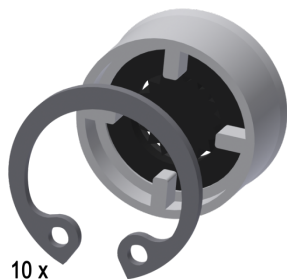

10 x

Flow controller 9,0 l/min

2000104782

ESHHE0001



Cover

2030031443

ESHOW0059



Temperature handle

2030047082

ASXT9003

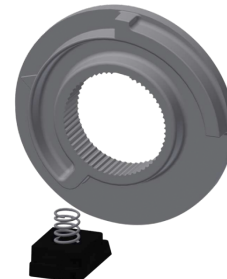

Temperature stop

2030003296

EAQLT0003

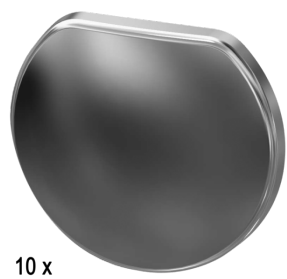

10 x

Plug chromed

2030053006

ASSX9004



Push cap

2030049943

ASST2001



Guide ring

2030048356

ASSX9002

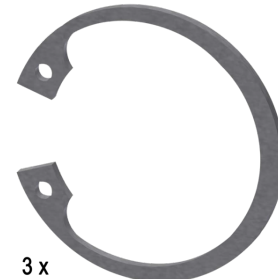

3 x

Safety ring

2030048357

ASSX9003

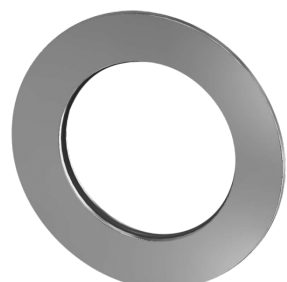

Rosette

2030048765

ASET2006



FRAMIC Self-closing cartridge

2030046145

ASSX9001



Disassembly tool

2030047203

ACXX9003