

F5E Therm MIRANIT shower panel

MODEL RANGE: F5 | F5ET2024 | 210.0596.036

Showers | Electronic self closing shower

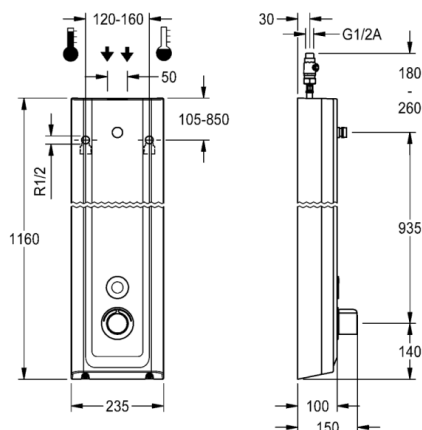

F5E Therm shower panel made of mineral material for wall mounting with thermostatic mixer and connecting nozzles for the shower head. Electrically controlled, for connection to hot water and cold water. Shower valve with integrated solenoid valve cartridge, thermostat and mechanism for optional bypass solenoid valve cartridge to perform program-controlled thermal disinfection. Thermostat with metal handle, an adjustable and turn-proof temperature stop and an option for manual thermal disinfection. All-metal construction, visible parts high-polished or chrome-plated. Connecting nozzles for the required additional DN 15 Franke shower head with pre-fitted flow regulator 9.0 l/min. Housing with raised function surface made of MIRANIT resin-bonded mineral material with pore-free smooth surface (temperature-resistant up to 80 °C), Alpine white colour. Button sensor including control electronics with start/stop function and deactivation for cleaning. Connecting hoses with lockable water volume control with backflow preventer and strainer. Activated water hygiene flushing 24 hours after last activation and saving of statistical data. With option for parameterization and communication via the optional bidirectional remote control. Battery operation with 6 V lithium battery (CR-P2) per fitting, separate power supply via plug-in power supply unit 6.75 V/12 V DC or AQUA 3000 open system accessories.

Dimensions of housing 235 x 1160 x 100 mm (W x H x D)

Shower head and battery compartment including battery or plug-in power supply unit with extension cable to be ordered separately.

Technical data

Overall depth	100.00 mm
Overall height	1,160.00 mm
Overall width	235.00 mm
Tailor made	No
Type of mounting	Wall mounting
Type of operation	Sensor operation
Diameter nominal	DN 15
Inlet size	G-1-2-A
Material casing	Mineral material
Material fitting	Brass
Type of mixing	Thermostat
Sound insulation	No
Surface finish fitting	Chromed
Minimum flow pressure	1.50 bar
Volume flow rate at 3 bar	0.15 liter per second
Adjustable flow time	Yes
Functional principle	Electronic self-closing
Protective shutdown	Yes
Thermal disinfection	Prepared for automatic thermal disinfection
Default automatic hygiene flushing	24h after the last activity
Power supply connection	6.75 / 12 V DC / A3000 open
Type of sensor	Opto-electronic sensor
Additional connections	No
Circulation	No
Connection with pay water dispenser	via electronic module
Shower pipe draining	No
Type of shower	Shower panel

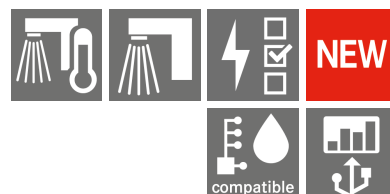

FRANKE

F5E Therm MIRANIT shower panel

MODEL RANGE: F5 | F5ET2024 | 210.0596.036

Showers | Electronic self closing shower

Accessory Mandatory



AQUAJET-Slimline shower head for F5 shower panels

2030054255

SHAS0011



AQUAJET-Comfort shower head for F5 shower panels

2030054254

SHAC0011



MÜNCHEN shower head for F5 shower panels

2030054793

SHMU0011



Battery compartment

2000109466

ZAQCT0003

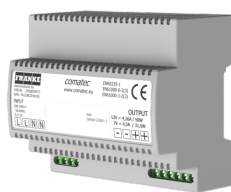

Power supply unit

2030039477

ACEX9001

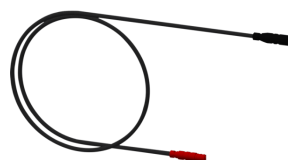

Extension cable 5 m

2030043814

ACEX9010

Accessory Optional

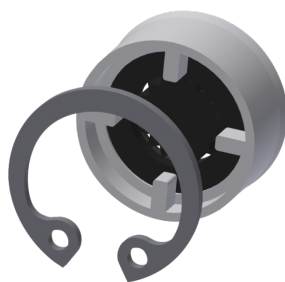

Flow controller 12,0 l/min

2000104783

ESHHE0002



Bidirectional remote control for electrical fittings F3 and F5

2030036654

ACEX9005



2-button remote control for fittings F3 and F5

2030036849

ACEX9004



Housing extension for F5 shower panels made of MIRANIT

2030057071

ACXX2016

F5E Therm MIRANIT shower panel

MODEL RANGE: F5 | F5ET2024 | 210.0596.036

Showers | Electronic self closing shower

Accessory Optional



Housing extension for F5 shower panels made of MIRANIT

2030057072
ACXX2017



Housing extension for F5 shower panels made of MIRANIT

2030057073
ACXX2018



Housing extension for F5 shower panels made of MIRANIT

2030057075
ACXX2019



Housing extension for F5 shower panels made of MIRANIT

2030057076
ACXX2020



Electronic module EM5 for F5 shower taps

2030041918
ACET2001



Connection adapter

2000101441
AQRM928

Spare Parts



Cover

2030031443
ESHOW0059



Temperature handle

2030047082
ASXT9003

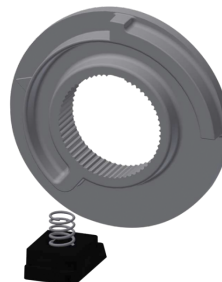

Temperature stop

2030003296
EAQLT0003



Solenoid valve cartridge

2030003033
EAQFU0001

F5E Therm MIRANIT shower panel

MODEL RANGE: F5 | F5ET2024 | 2030056563

Showers | Electronic self closing shower

Spare Parts

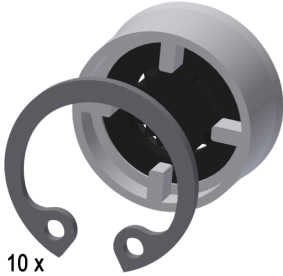

10 x

Flow controller 9,0 l/min

2000104782

ESHHE0001



Disassembly tool

2030047203

ACXX9003
