

ELECTRONIC PILLAR MIXER

F3EM1001 | 2030033388

PRODUCT GROUP (PG) : Taps | ARTICLE FAMILY (AF) : Electronic tap | ARTICLE GROUP (AG) : F3EM1001 ++ |
 MODEL RANGE : F3 | LIFECYCLE : New

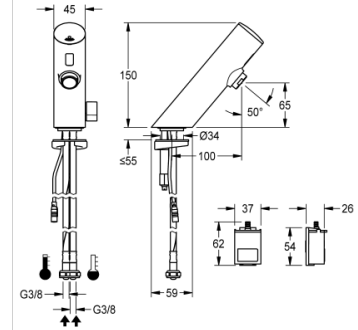

F3E-Mix pillar mixer DN 15 for sanitary facilities, opto-electronically controlled. For connection to hot and cold water via hoses with integrated backflow preventer and strainers. Control electronics, solenoid valve cartridge and sensor in all-metal housing, high-polished chromium-plated brass, with temperature lever and adjustable, turn-proof temperature stop. Aerator with integrated flow regulator 6.0 l/min. Activated water hygiene flushing 24 hours after last activation, safety switch-off with continuous reflection and saving of statistical data. With option for parameterization and communication via optional, bidirectional remote control. With battery compartment including 6 V lithium battery (CR-P2) for installation under the washbasin.

TECHNICAL DATA

Gross Weight	1.47 kg
Net Weight	1.40 kg
Functional Principle	ELECTRONIX-C
Type Of Mixing	YES
Power Supply Connection	BATTERY-6-V
Type Of Mounting	TAPHOLE
Type Of Tap	PILLAR-TAB
Calculation Flow Rate Cold Water	0.07 liter per seconds
Calculation Flow Rate Hot Water	0.07 liter per seconds
Default Automatic Hygiene Flushing	24H-AFTER-ACTIVITY
Depressurised	NO
Diameter Nominal	DN-15-1-2INH
Material Fitting	BRASS
Minimum Flow Pressure	1.00 bar
Position Of Power Connection	BOTTOM
Power Consumption	1.5
Protective System Ip	59K
Protective Shutdown	YES
Sound Insulation	NO
Spout Projection	100.00 mm
Surface Finish Fitting	CHROMISED
Thermal Disinfection	NO
Type Of Operation	SENSOR-OPERATION
Type Of Sensor	OPTO-ELEC-SENSOR
Volume Flow Rate At 3 Bar	0.10 liter per seconds

Inlet Size

G3-8

ELECTRONIC PILLAR MIXER

F3EM1001 | 2030033388

PRODUCT GROUP (PG) : **Taps** | ARTICLE FAMILY (AF) : **Electronic tap** | ARTICLE GROUP (AG) : **F3EM1001 ++** |
MODEL RANGE : **F3** | LIFECYCLE : **New**

ACCESSORIES

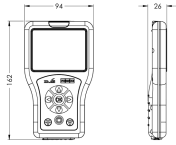

REMOTE CONTROL

2030036654

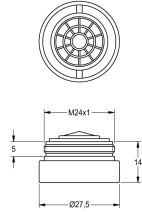

AERATOR

2000101160

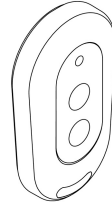

REMOTE CONTROL

2030036849

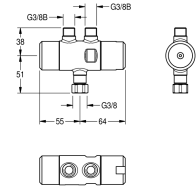

THERMOSTATIC MIXING VALVE

2030012758

SPARE PARTS

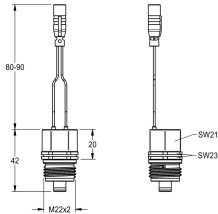

SOLENOID VALVE CARTRIDGE

2030003033

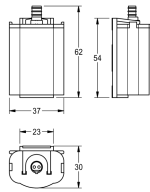

BATTERY COMPARTMENT

2000109466